

SOU2300TX



Category	24"
Product family	Oven
Power supply	Electrical
Cooking method	Thermo-ventilated
Cleaning system	VaporClean
EAN code	8017709341954



Aesthetic

Aesthetics	Classic	Stainless steel type	Brushed
Color	Stainless steel	Silkscreen color	Black
Finishing	Fingerprint-proof	Silkscreen type	Symbols and wordings
Design	Flat	Handle color	Stainless steel
Material	Stainless steel	Logo	Embossed

Controls



Display name	DigiScreen	Display technology	LED
--------------	------------	--------------------	-----

Programs / Functions

No. of cooking functions 8

Traditional cooking functions

Static	Fan-assisted	True European convection
Turbo	Eco	Large grill
Fan grill (large)	Bottom	

Other functions

Defrost by time

Cleaning functions

 Vapor Clean

Options



Time-setting options	Delayed start and automatic shut-off when cooking ends	Timer	1
Minute minder	Yes	Rapid pre-heating	Yes

Technical Features



Minimum Temperature	38 °F	Grill element - power	1700 W
Maximum temperature	260 °F	Large grill - Power	2700 W
No. of shelves	5	Circular heating element - Power	1550 W
Fan	Single	Heating elements stop when door is opened	Yes
No. of lights	2	Door	Cool-touch door
Lighting	Halogen	Removable inner door	Yes
Replaceable light	Yes	Total no. of door glasses	3
Light power	40 W	Cooling system	Tangential
Light on when door is open	Yes	Cooling duct	Double
Lower heating element power	1200 W	Cooling System Speed Reduction	Yes
Upper heating element - Power	1000 W	Cavity material	EverClean enamel

Performance / Energy Label



Volume of the cavity 2.54 cu. ft.

Accessories Included



Rack with back stop	2	Insert grid	1
Enameled 1.6"-deep tray	1	Telescopic Guide rails, partial Extraction	1

Electrical Connection

Voltage	120/240 V	Current	13 A
----------------	-----------	----------------	------

Plug	Hard-wired	Frequency	60 Hz
Nominal power	3400 W	Power cord length	59 1/16 "
Voltage	120/208 V		

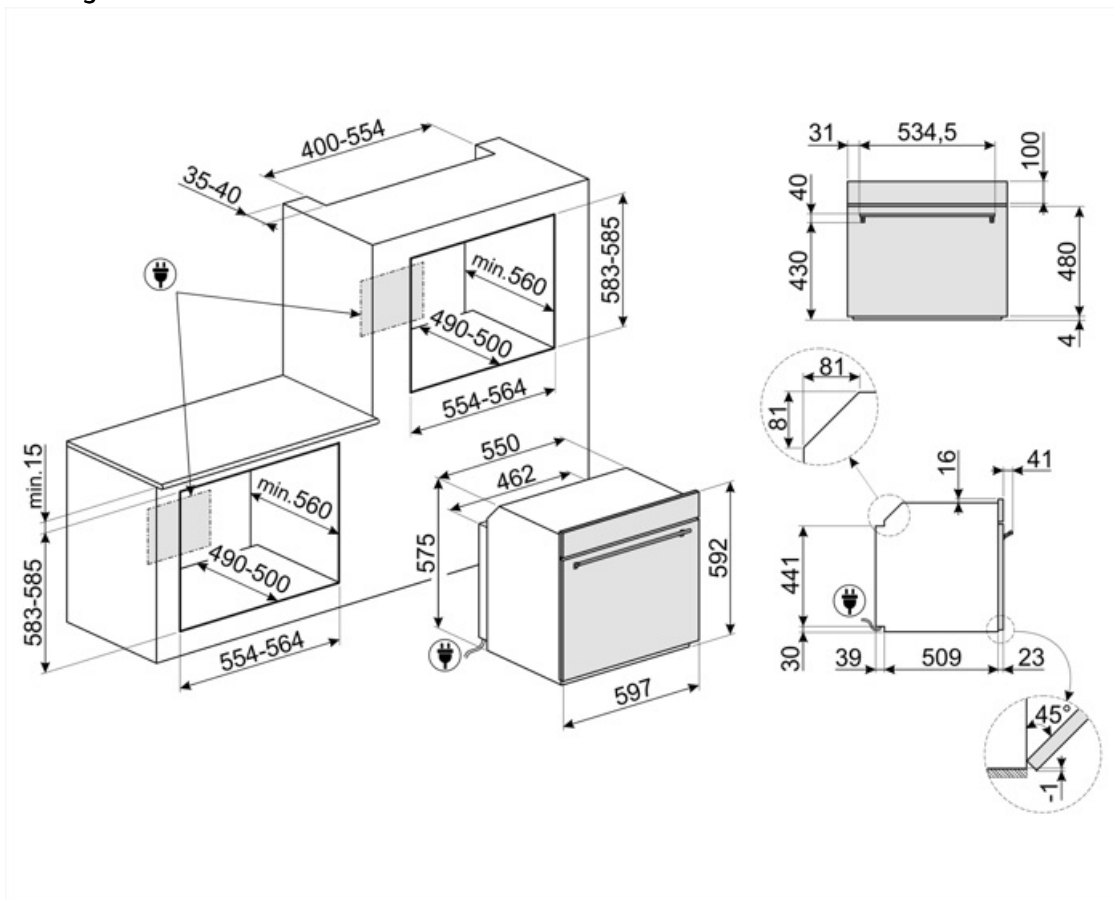

Compatible Accessories

BN620-1

Enamelled tray, 20mm deep



GTP

****Partial-extension telescopic guides****
Length: 14" Extraction: 11 1/4" Material:
Stainless steel AISI 430 polished



PALPZ

Pizza shovel with fold away handle
width: 315mm length : 325mm



BN640

Enamelled tray, 40mm deep



GTT

****Total-extension telescopic guides****
Length: 14" Extraction: 16.5" Material:
Stainless steel AISI 430 polished



























STONE2

Rectangular pizza stone without handles, suitable for 45cm and 60cm wide ovens. Dimensions W42 x H1.8 x D37.5cm. Ideal for cooking pizzas with the same results as a typical wood-fired oven. Can also be used for baking bread, focaccias and other recipes such as pies, flans or biscuits



Symbols glossary

 <p>A: Product drying performance, measured from A+++ to D / G depending on the product family</p>	 <p>Air cooling system: to ensure a safe surface temperatures.</p>
 <p>Defrost by time: with this function the time of thawing of foods are determined automatically.</p>	 <p>Triple glazed doors: Number of glazed doors.</p>
 <p>Electric</p>	 <p>Enamel interior: The enamel interior of all Smeg ovens have a special antacid lining which helps keep the interior clean by reducing the amount of cooking grease adhering to it.</p>
 <p>Fingerprint proof stainless steel: Fingerprint proof stainless steel keeps stainless steel looking as good as new.</p>	 <p>Fan with upper and lower elements: The elements combined with the fan aim to provide more uniform heat, a similar method to conventional cooking, so pre-heat is required. Most suitable for items requiring slow cooking methods.</p>
 <p>Upper and lower element only: a traditional cooking method best suited for single items located in the centre of the oven. the top pf the oven will always be hottest. Ideal for roast, fruit cakes, bread etc.</p>	 <p>Lower heating element only: This function is ideal for foods that require extra base temperature without browning, e.g. pastry dishes, pizza. Also suitable for slow cooking of stews and casseroles.</p>
 <p>True European Convection: The combination of the fan and circular heating element around it provides many benefits, including no preheat if cooking time is longer than 20 minutes, no flavor transfer when cooking different foods at the same time, lower energy consumption, and shorter cooking times. Suitable for all types of food preparations.</p>	 <p>ECO: The combination of the grill, fan and lower element is particularly suitable for cooking small quantities of food.</p>
 <p>Grill element: Using of grill gives excellent results when cooking meat of medium and small portions, especially when combined with a rotisserie (where possible). Also ideal for cooking sausages and bacon.</p>	 <p>Fan with grill element: The fan reduces the fierce heat from the grill, providing an excellent method of grilling various foods, chops, steaks, sausages etc. giving even browning and heat distribution, without drying out the food. The top two levels recommended for use, and the lower part of the oven can be used to keep items warm at the same time, an excellent facility when cooking a grilled breakfast. Half grill (centre portion only) is ideal for small quantities of food.</p>
 <p>Circulaire with upper and lower elements: The use of the fan with both elements allows food to be cooked quickly and effectively, ideal for large joints that require thorough cooking. It offers a similar result to rotisserie, moving the heat around the food, instead of moving the food itself, enabling any size or shape to be cooked.</p>	 <p>All glass inner door: All glass inner door, a single flat surface which is simple to keep clean.</p>
 <p>The inner door glass: can be removed with a few quick movements for cleaning.</p>	 <p>Side lights: Two opposing side lights increase visibility inside the oven.</p>

-
-  Rapid preheat: The rapid preheat function can be used to reach the selected temperature in just a few minutes.
 -  Telescopic rails: allow you to pull out the dish and check it without having to remove it from the oven entirely.
 -  The capacity indicates the amount of usable space in the oven cavity in litres.
 -  ...
 -  The oven cavity has 5 different cooking levels.
 -  Vapor Clean: a simple cleaning function using steam to loosen deposits in the oven cavity.
 -  The capacity indicates the amount of usable space in the oven cavity in litres.