

# EGG CHAIR







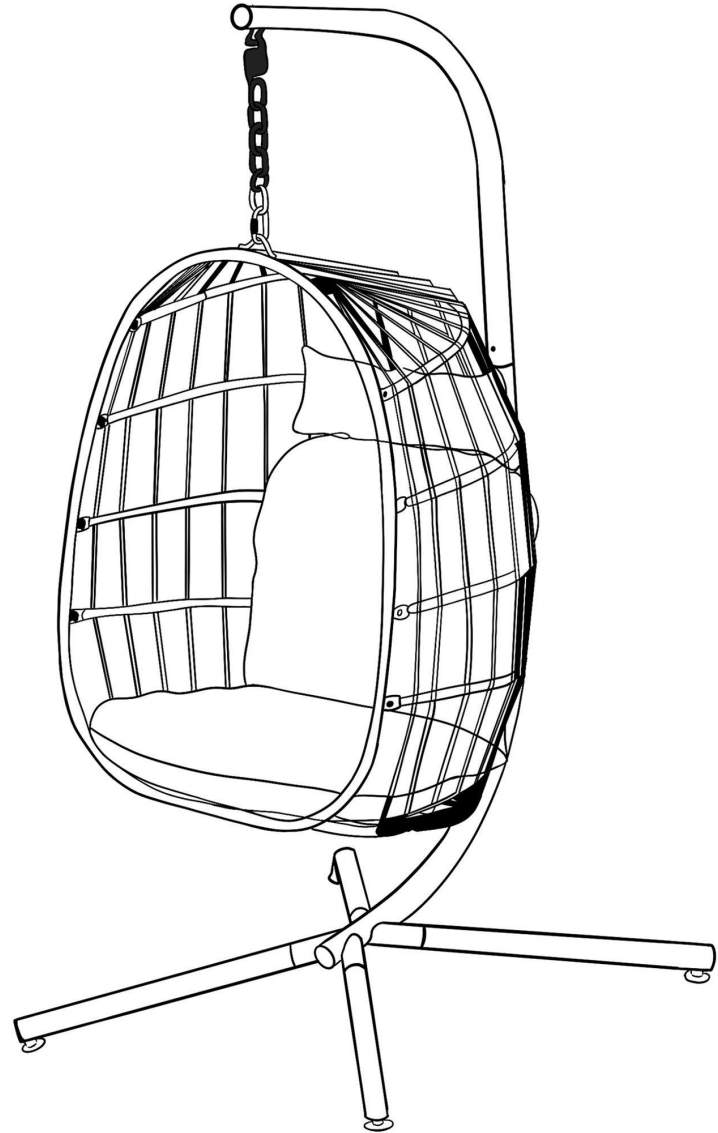

## Installaton Instructions

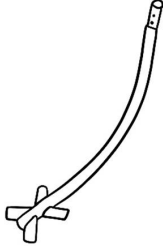

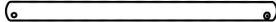
**Item Weight:50LBS**

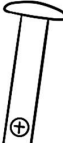
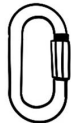
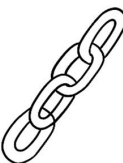
**Load Capacity:350LBS**

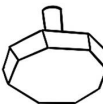
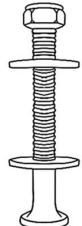
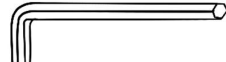
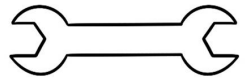

|   |   |  |   |   |   |   |   |
|---|---|--|---|---|---|---|---|
|    |   |                       |   |    |   |    |   |
| A   | 1 | B  | 1 | C   | 4 | D   | 1 |
|    |   |                       |   |    |   |    |   |
| E   | 1 | F  | 1 | G   | 1 | H   | 1 |
|  |   | <br>reinforcement   |   |  |   |  |   |
| I   | 1 | J  | 4 | K   | 1 | L   | 1 |
|  |   | <br>height adjuster |   |   |   |   |   |
| M   | 1 | N  | 4 |   |   |   |   |

Step 1: Screw the 4 height adjusters (N) into the ends of the 4 support legs(C)

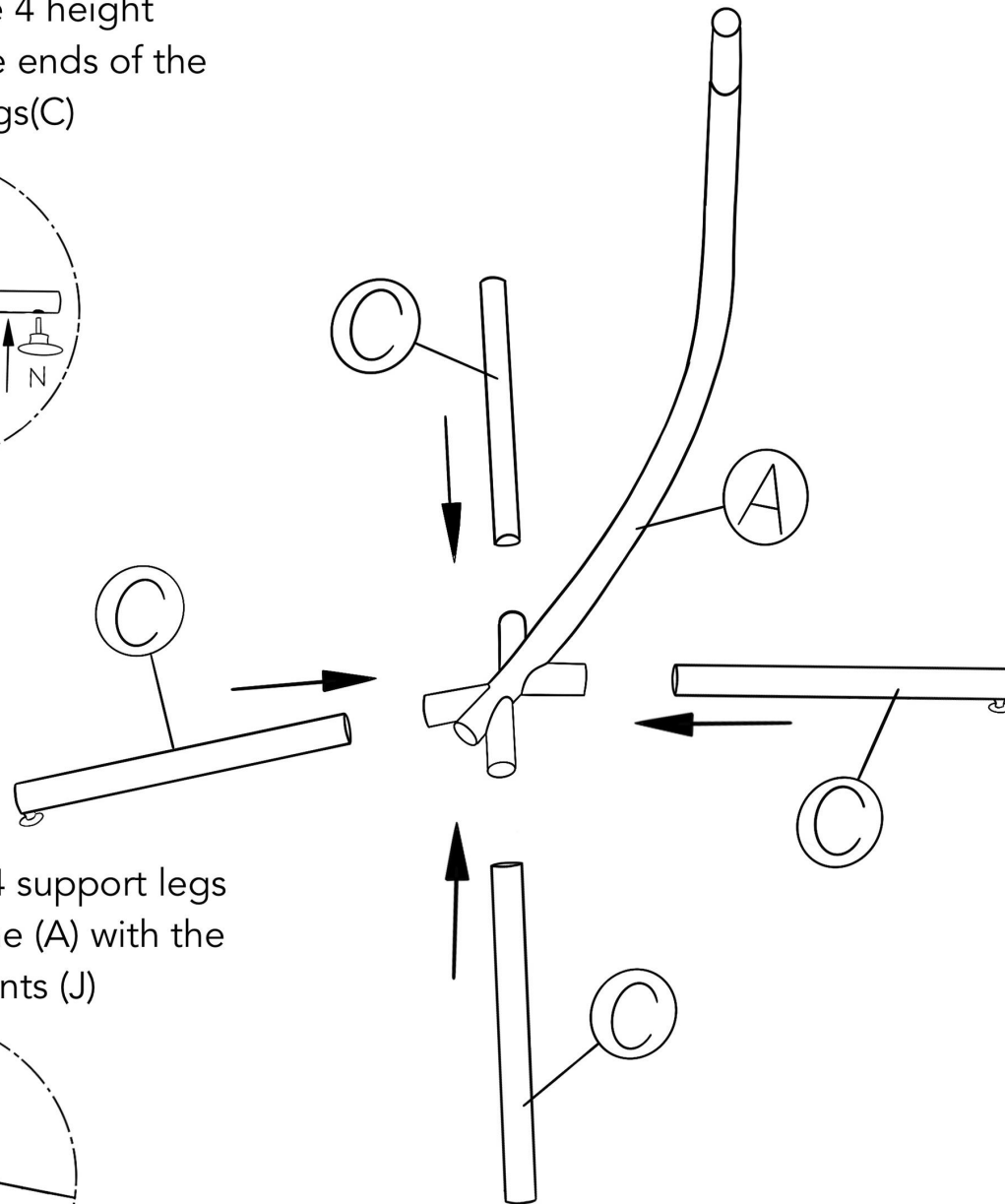
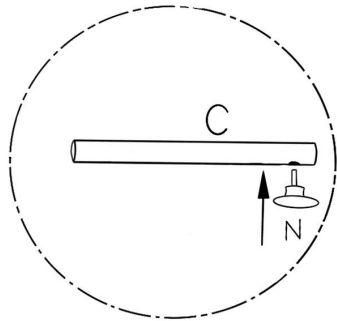

Step 2: Fasten the 4 support legs (C) to the base frame (A) with the reinforcements (J)

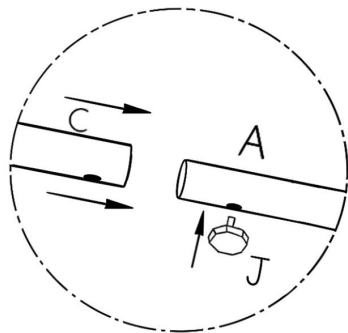

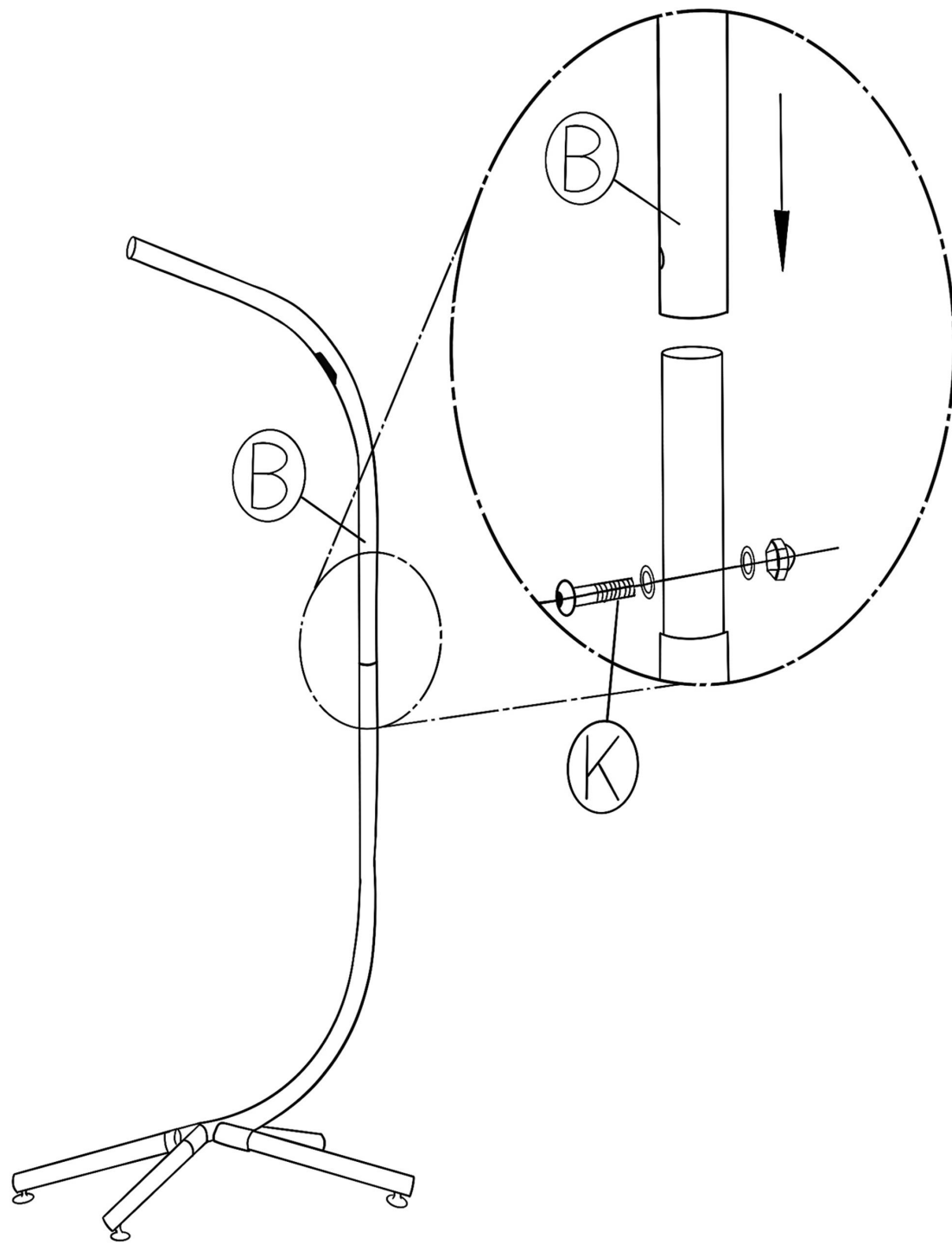

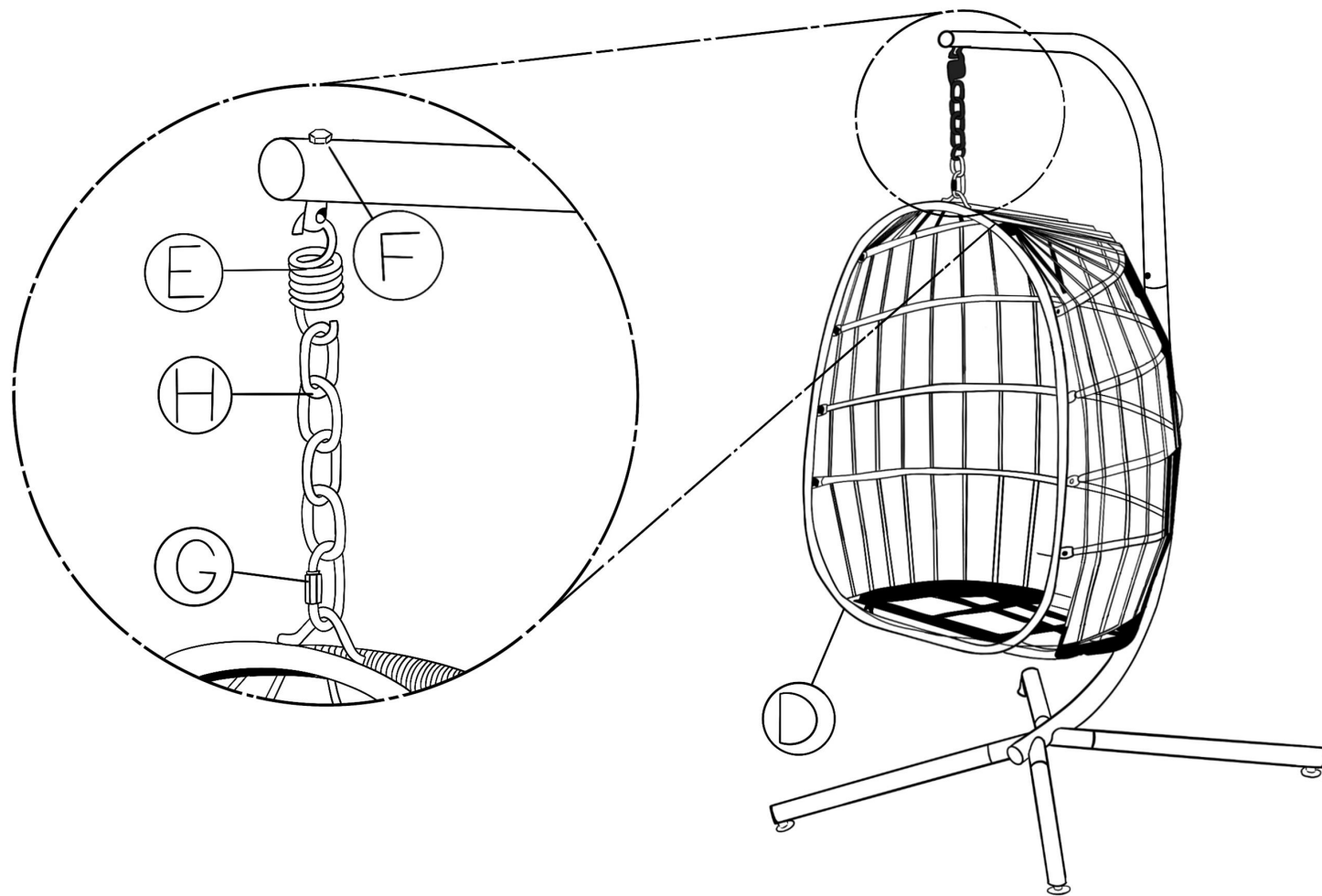

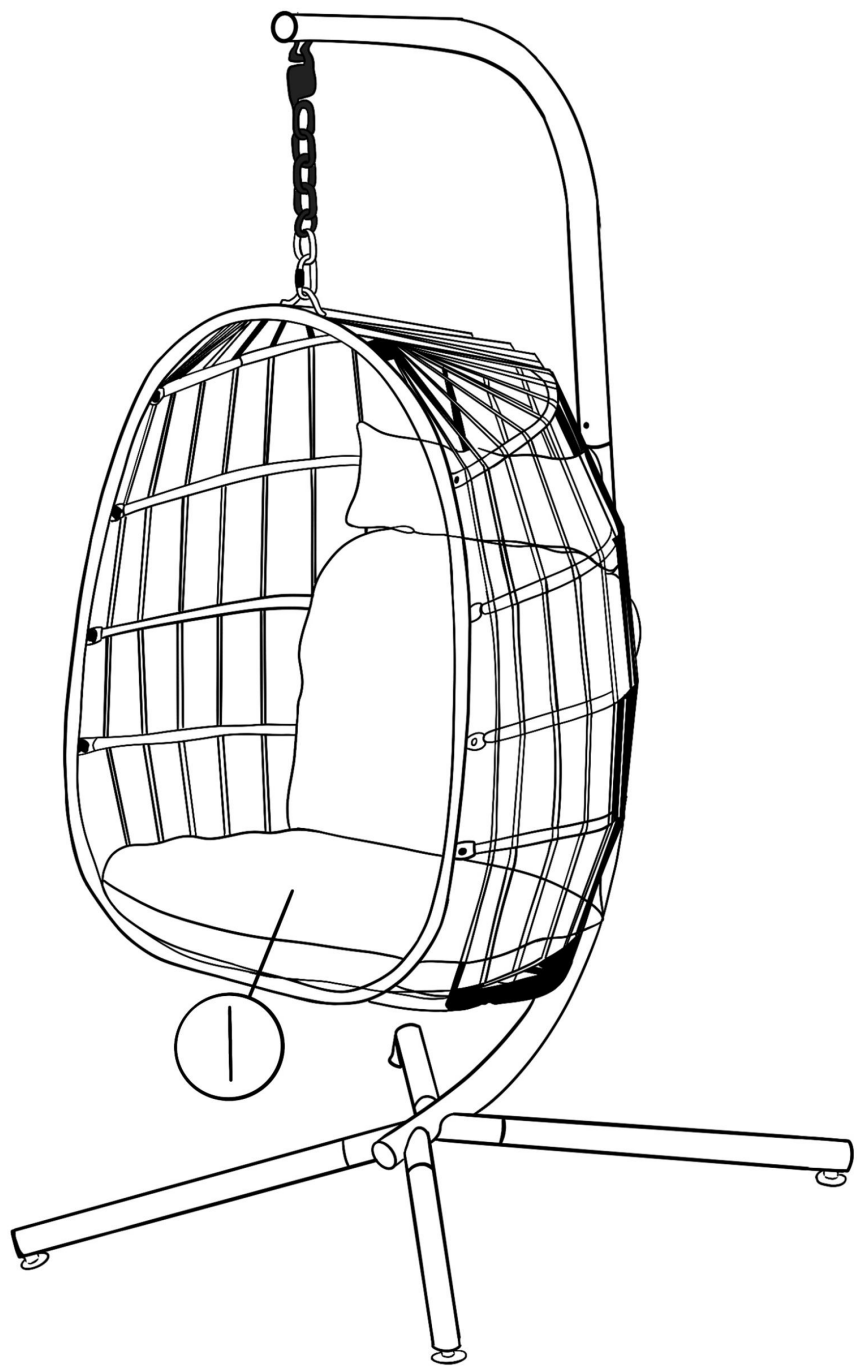

# EGG CHAIR

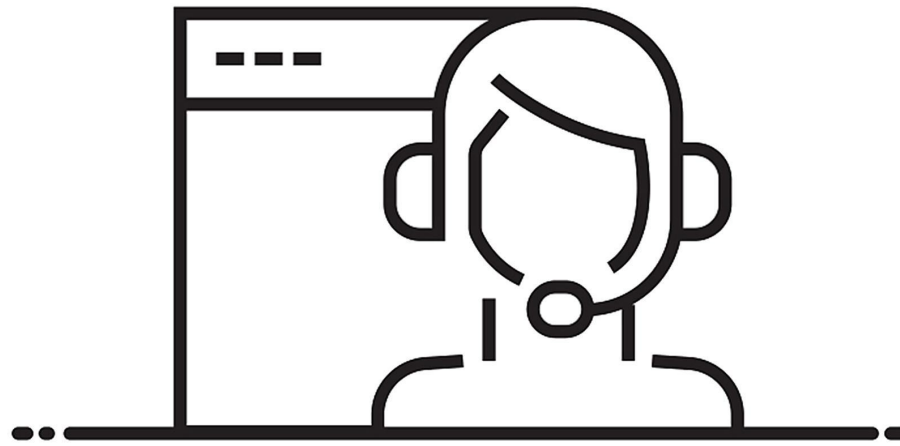

## ONLINE SUPPORT

Please read the installation guide carefully before installation  
If you have any questions during the installation process  
you can contact us and we will provide you a detailed guidance