

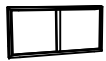



ASSEMBLY INSTRUCTIONS

QUEEN BED(3 +3)

(BOX 1)

BOX OF HEADBOARD

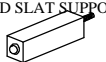
NO	ITEM	QTY
A	HEADBOARD 	1 PC
B	FOOTBOARD 	1 PC
C	HB LEG L&R 	2 PCS
D	SLAT 	3 PCS
E	BED SLAT SUPPORT 	3 PCS

STEP 1 Attach Head Board Leg (C) to Head Board (A) as shown using JCBC BOLT(1)with Spring Washer (2), Flat washer (3) and securing with ALLEN KEY (4).

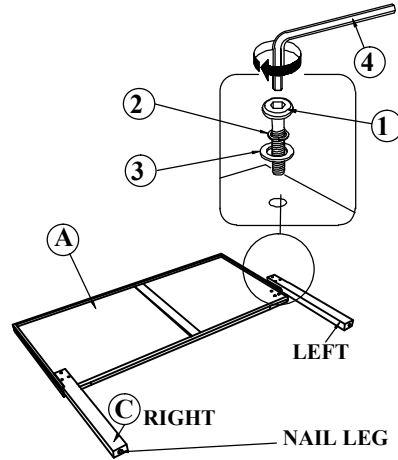

STEP 2 : Hook SIDE RAIL (F) TO HEAD BOARD (A) closely and push down to fit. repeat step 2 with other end of rail to hook onto FOOTBOARD (B).

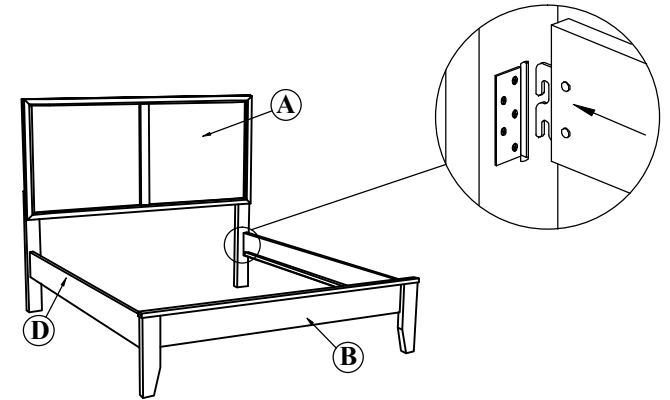

(BOX 2)





BOX OF SIDE RAIL

NO	ITEM	QTY
F	SIDE RAIL 	2 PCS

STEP 3 Fix the Bed Slats Support (E) to Bed Slats (D) as Shown and fix the Bed Slats to Side Rail (F) by using Flat Head Chipboard Screw (5). Loosen or Tighten the Adjuster as necessary to level the bed. Bed assembly should be done in final location to ensure stability.

(BOX 1)

HARDWARE LIST

NO	ITEM	QTY
1	JCBC BOLT M6 x 30MM BLK 	6 PCS
2	SPRING WASHER 1/4" RBW 	6 PCS
3	FLAT WASHER 1/4" ID x 13mmOD BLK 	6 PCS
4	ALLEN KEY m4 x 65mm BLK 	1 PC
5	FLAT HEAD CHIPBOARD SCREW m4 x 32mm RBW 	6 PCS

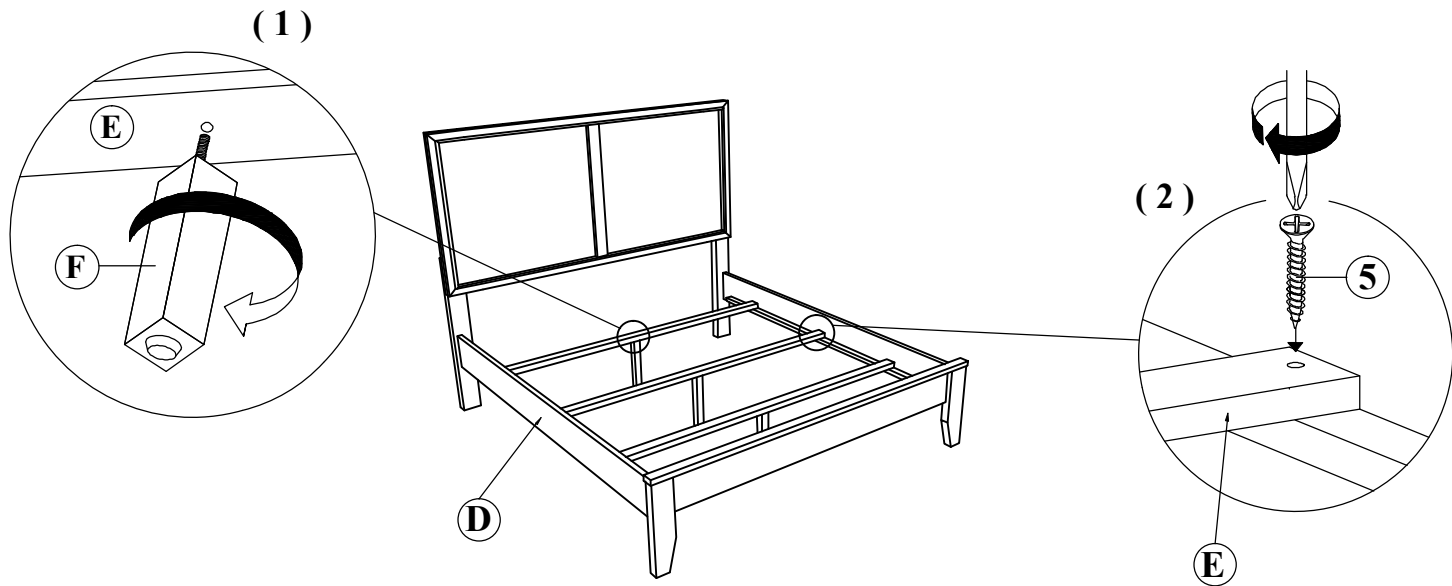

NOTE : MUST TIGHTEN SCREWS PERIODCALLY WITH USE SCREW WILL BECOME LOOSE CHECK TIGHTNESS OF ALL SCREW EVERY 6-8 WEEKS.