

To deodorize the chair, leave it in a shaded and well-ventilated outdoor area for 1-2 days.

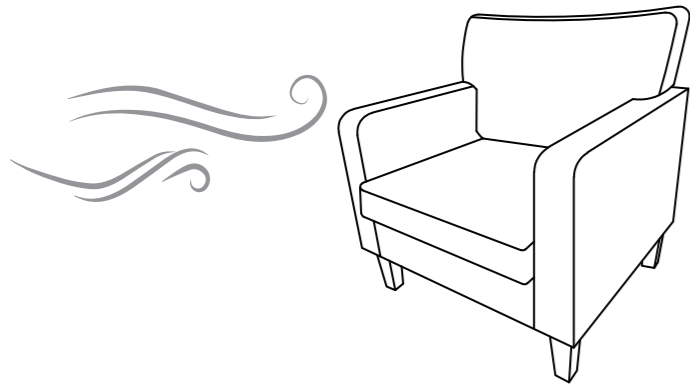

For long-term use, periodically retighten all bolts with the provided Allen Key. Do not use an electric screwdriver, as it may damage the chair. Always tighten the bolts manually.

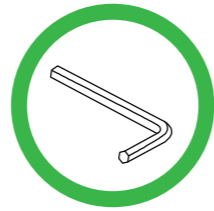

## Safety Information



# INSTRUCTION MANUAL

C-CZ01

✉ HJ-Customer-Service@outlook.com

☎ (909)637-7665 | (909)637-7593

# INSTRUCTION MANUAL

## C-CZ01

✉ HJ-Customer-Service@outlook.com

☎ (909)637-7665 | (909)637-7593

EST 9:00AM--17:00PM



## Parts List

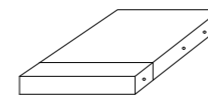

(A)\*1

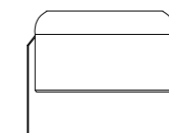

(B)\*1

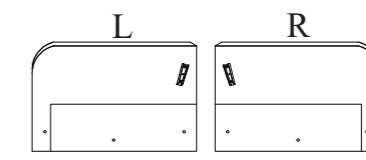

(C)L\*1+R\*1



(D)\*1

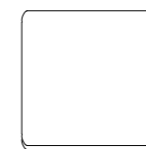

(E)\*1

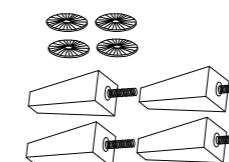

(F)\*4



(G)\*6

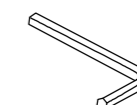

(H)\*1



(I)\*4

# Assembly Instruction

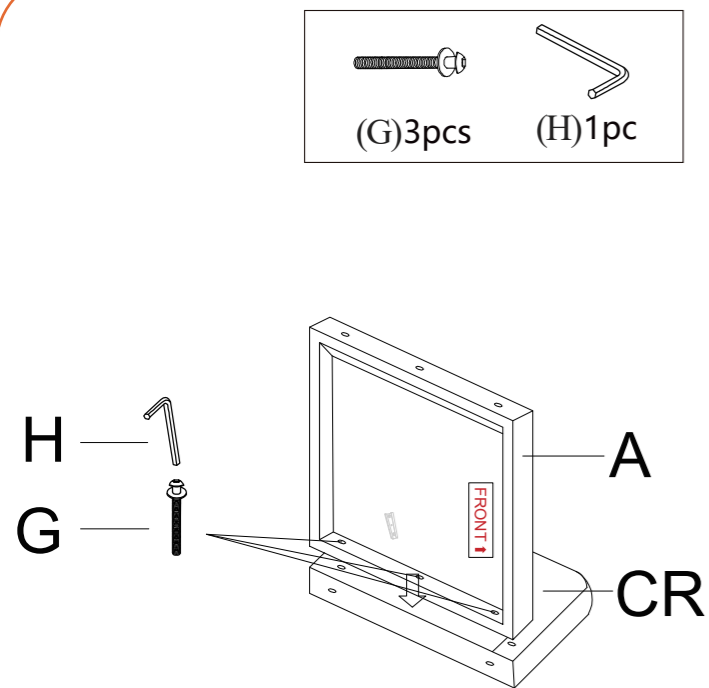

1

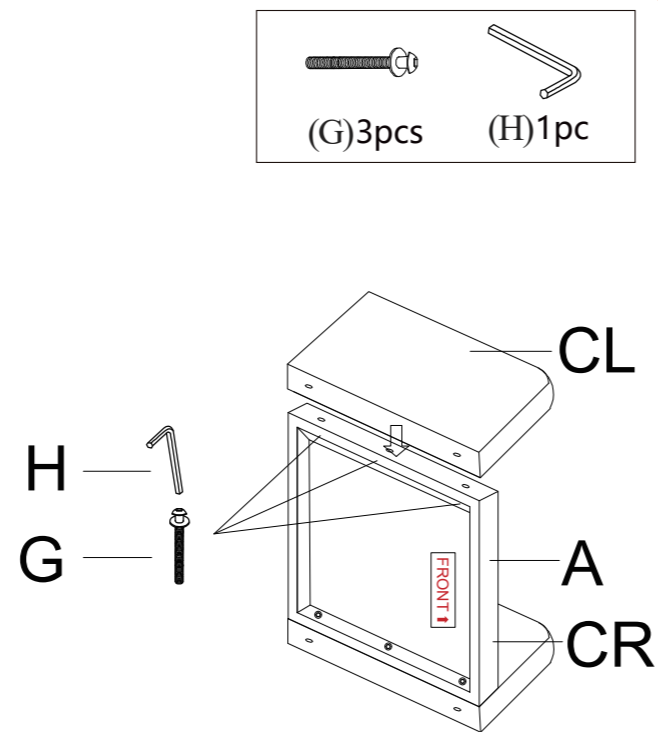

2

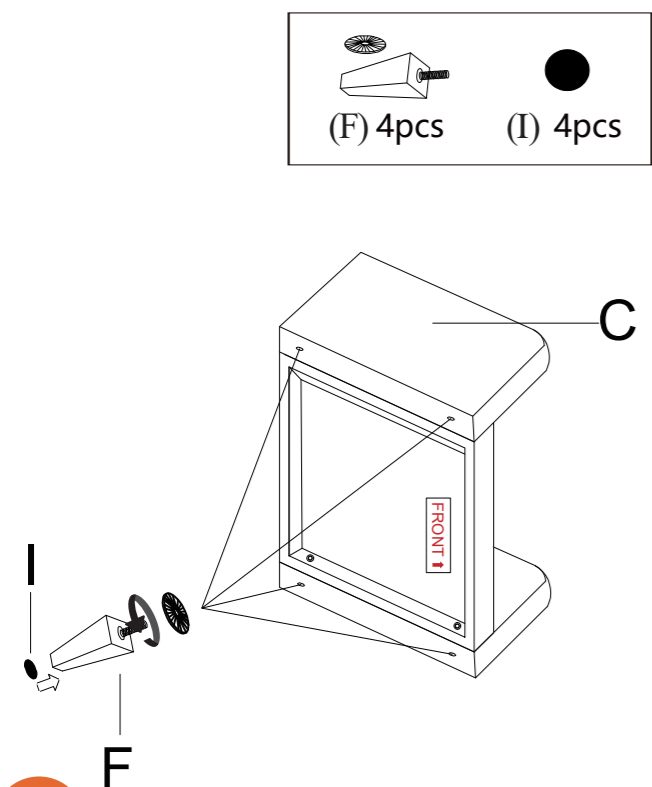

3

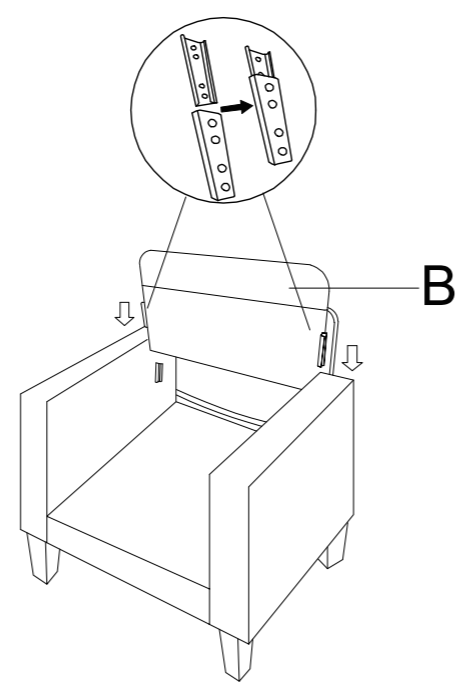

4

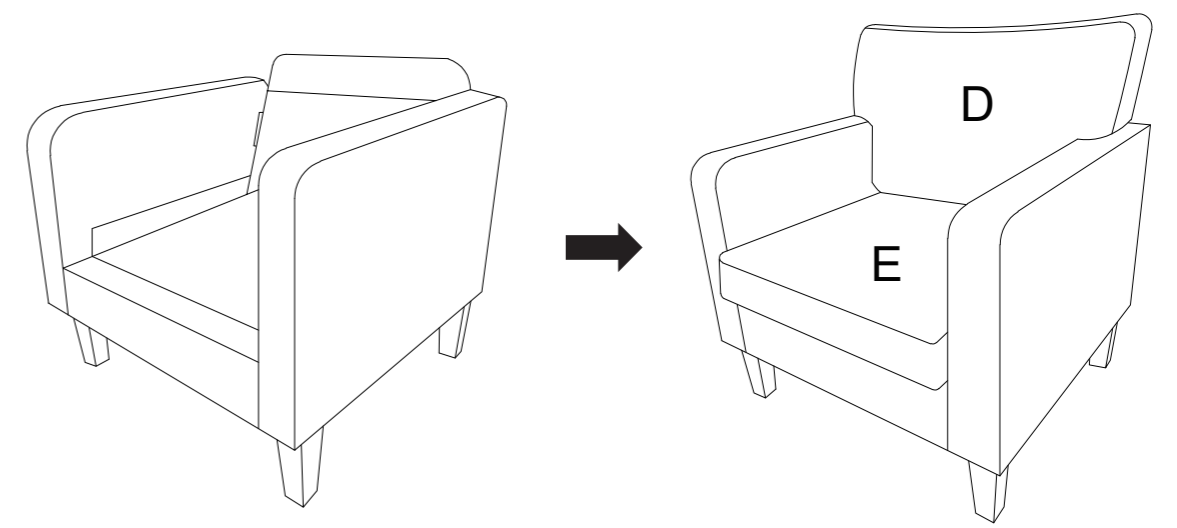

5

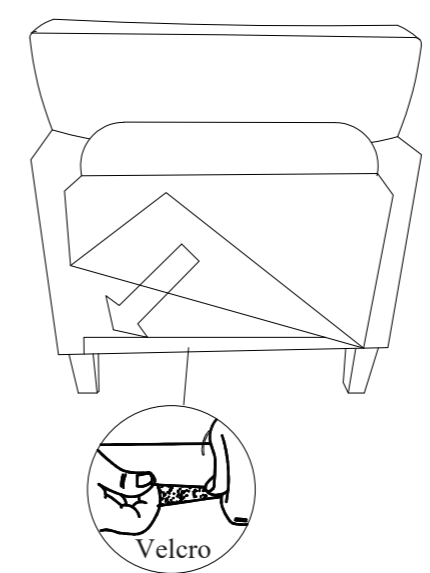

6

At the back of the chair, fasten the Velcro strip at the lower part of the backrest.

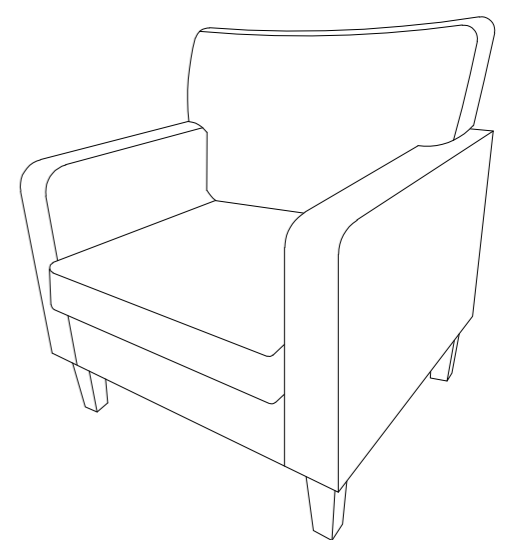

7

## CAUTION:

- \* Before using the chair, ensure that all bolts are fully tightened.
- \* Lubricate all moving parts and retighten all bolts every 6 months or as needed.