

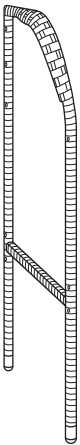

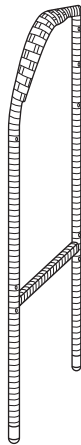
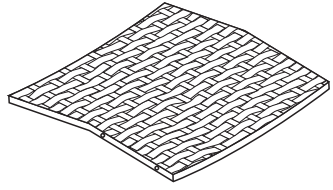
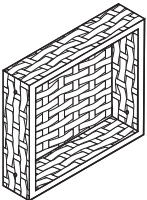
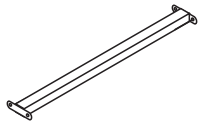
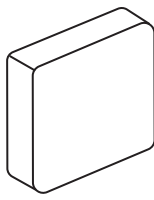

Outdoor Wicker Barstool

Instruction Manual

Parts List and Diagram

Part NO.	Reference Image	Qty.	Part NO.	Reference Image	Qty.
A		X4	B		X4
C		X4	D		X4
E		X8	F		X4

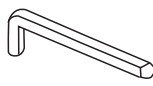
Part NO.	Reference Image	Qty.	Part NO.	Reference Image	Qty.
G	 6x35mm	X32	H	 6x15mm	X32
I		X16	J		X48
K		X1			

Assembly Steps

Note: When assembling the chair, remember not to fully tighten the screws at first (50% tightness is recommended). Fully tighten the screws after all the parts are installed.

STEP 1

A x 1 pc. **B** x 1 pc. **C** x 1 pc. **G** x 4 pcs.
I x 4 pcs. **K** x 1 pc.

Assemble one Part A, B, and C as the figure shows with four Part G and four Part I by using Part K to screw them.

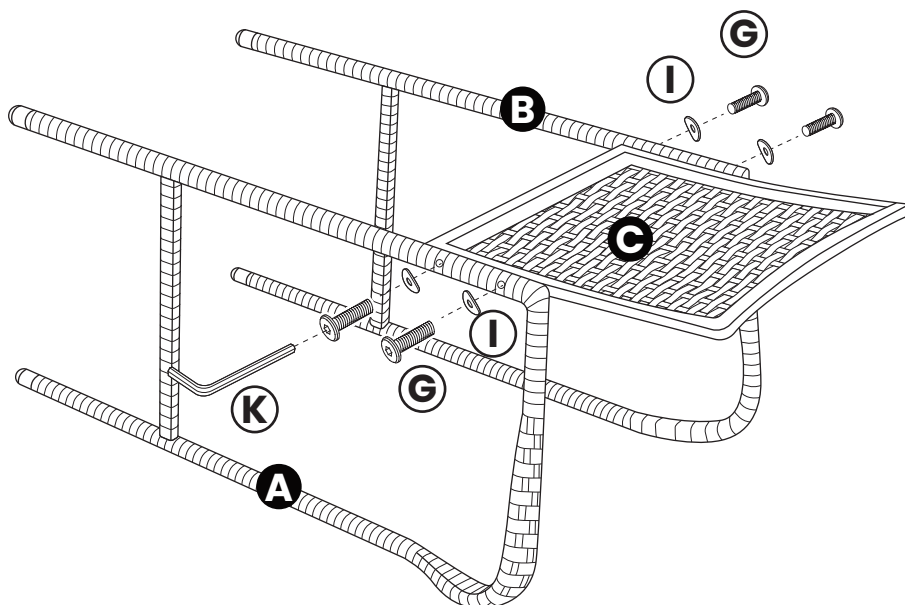

Assembly Steps

STEP 2

D x 1 pc. **G** x 4 pcs. **J** x 4 pcs. **K** x 1 pc.

Assemble one Part D to the position as shown in the figure with four Part G and four Part J by using Part K to screw them.

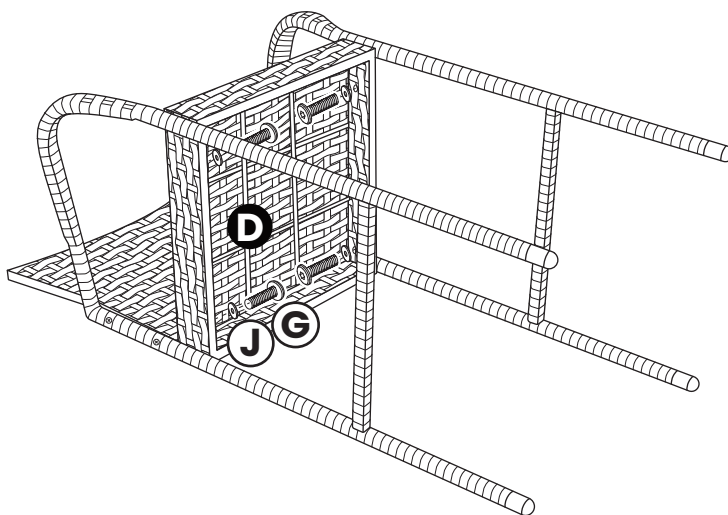

STEP 3

E x 2 pcs. **H** x 8 pcs. **J** x 8 pcs. **K** x 1 pc.

Assemble two Part E to the position as shown in the figure with eight Part H and eight Part J by using Part K to screw them.

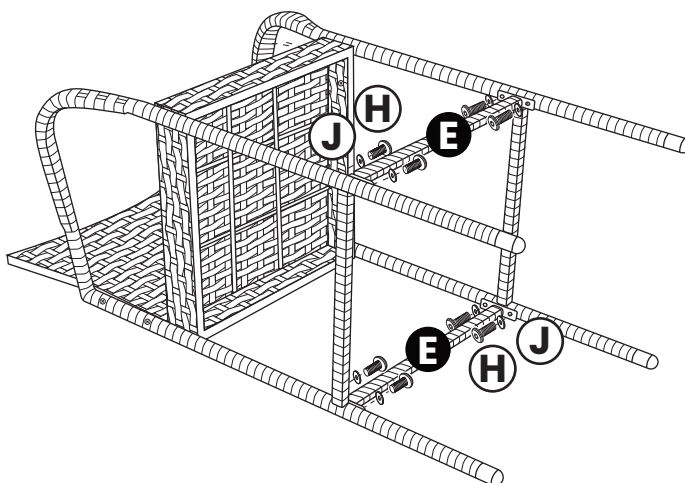

Assembly Steps

STEP 4

F x 1 pc.

Put one Part F on the chair. The installation of a single chair is complete.

