

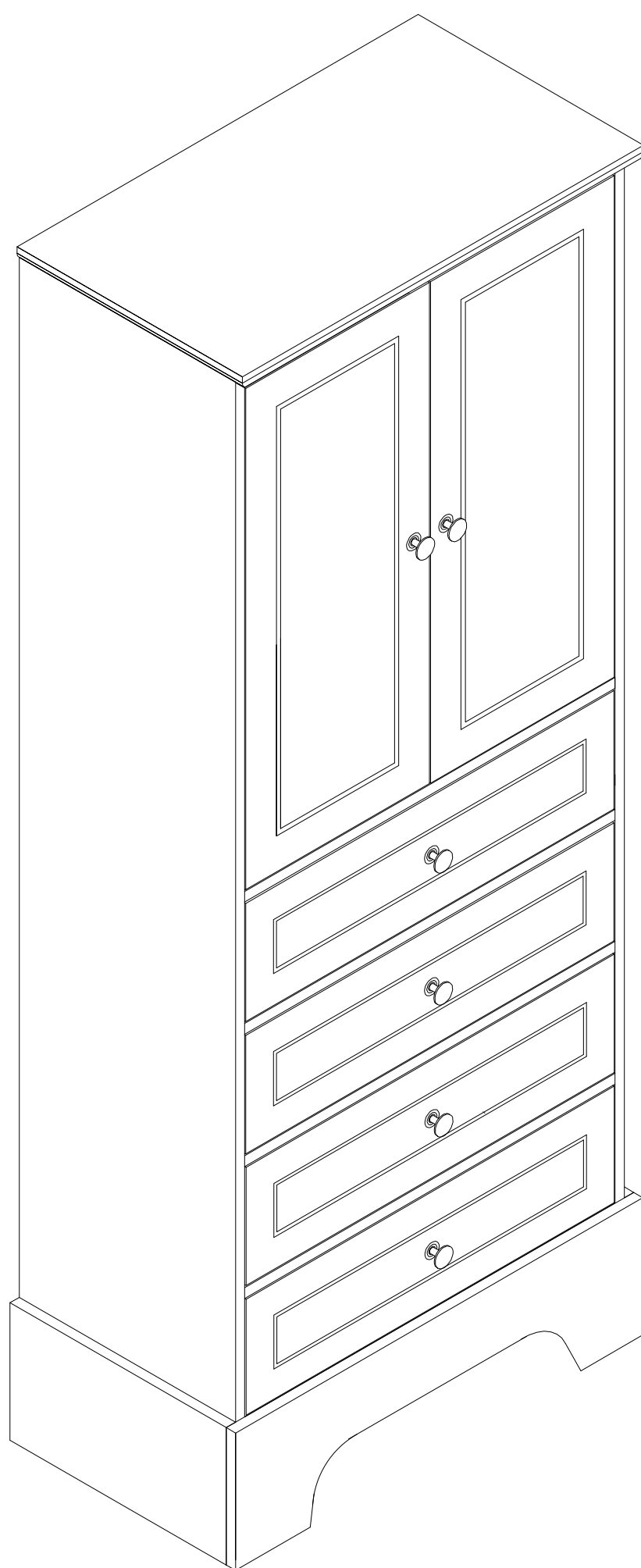

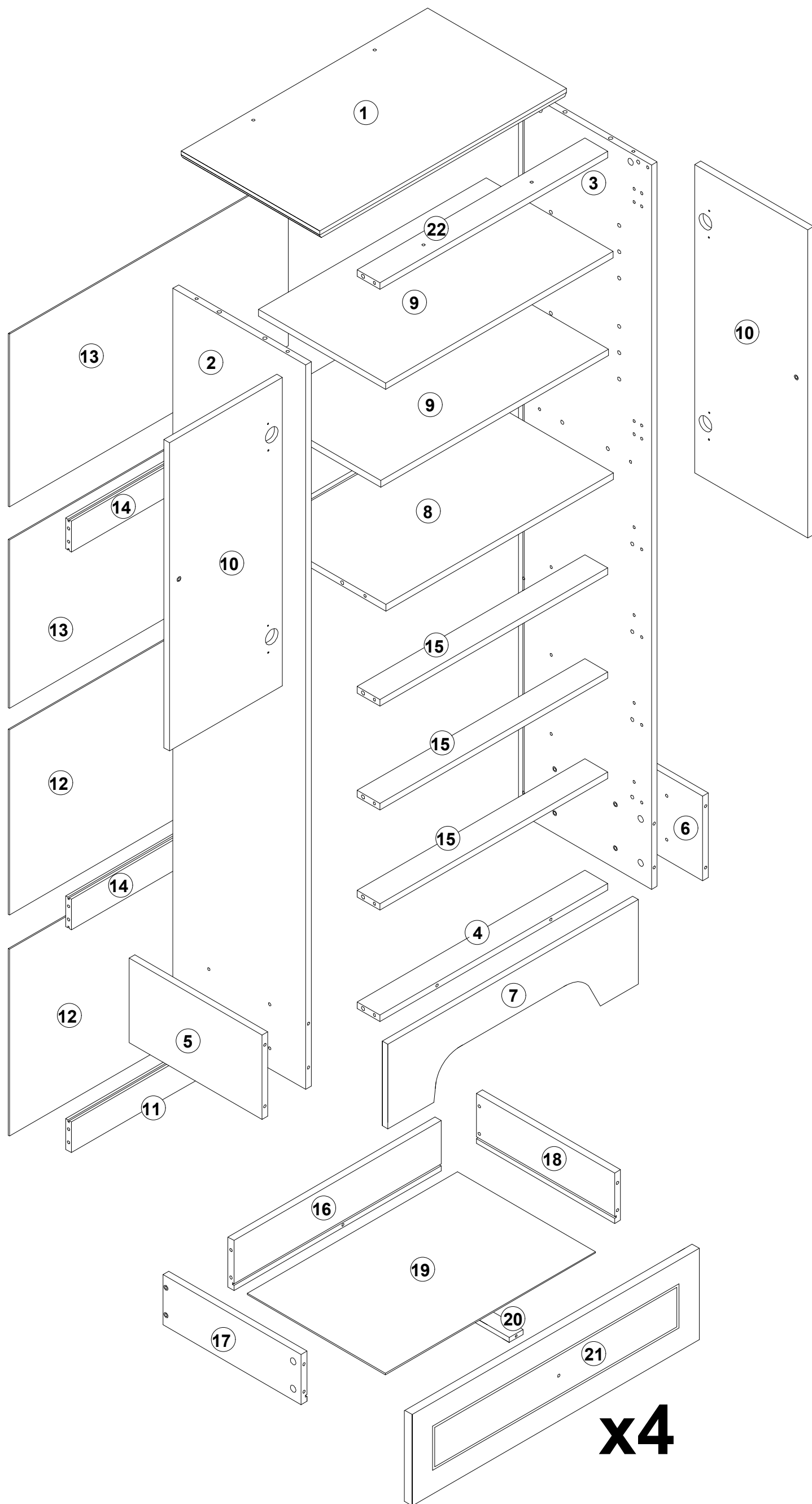

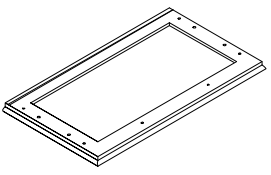

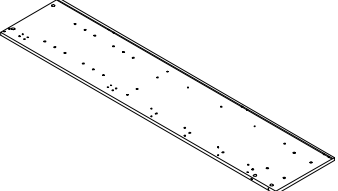

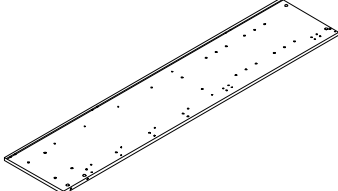
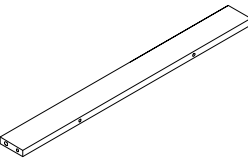
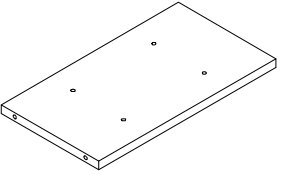
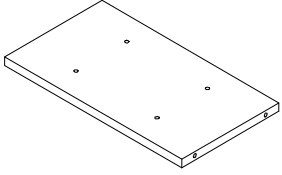
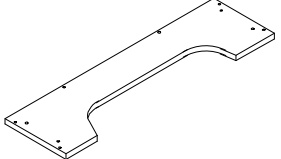
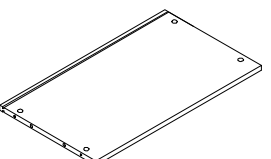
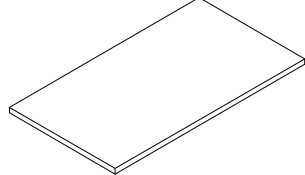
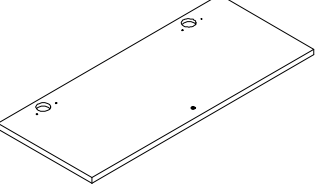
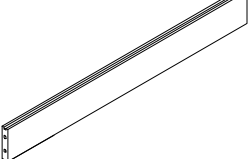
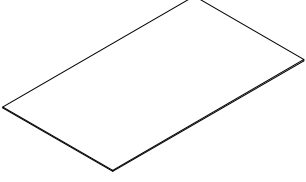
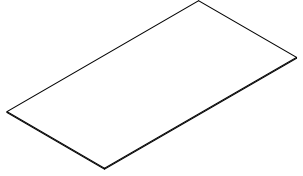
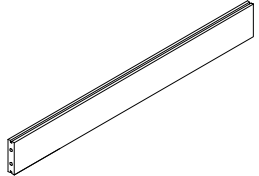
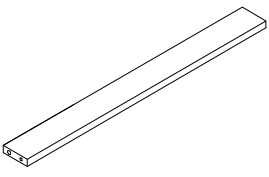
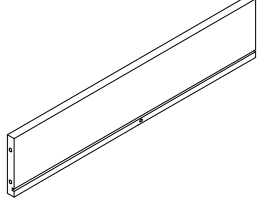
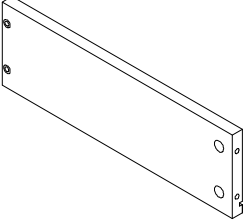
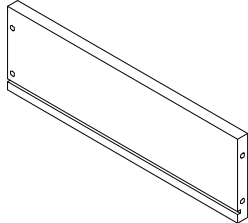
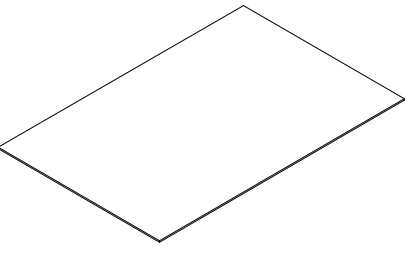
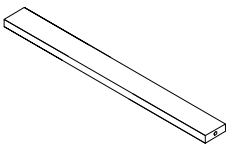
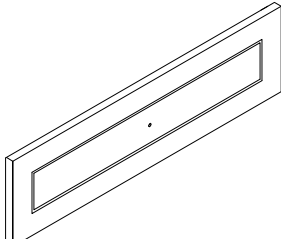
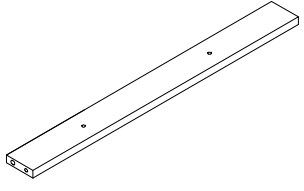

ASSEMBLY INSTRUCTION

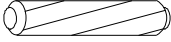

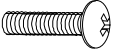

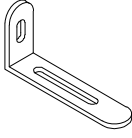
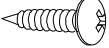
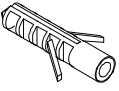
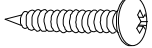
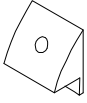
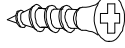
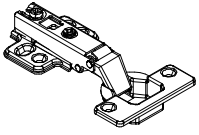
x4

			
① x 1	② x 1	③ x 1	④ x 1
			
⑤ x 1	⑥ x 1	⑦ x 1	⑧ x 1
			
⑨ x 2	⑩ x 2	⑪ x 1	⑫ x 2
			
⑬ x 2	⑭ x 2	⑮ x 3	⑯ x 4
			
⑰ x 4	⑱ x 4	⑲ x 4	⑳ x 4
			
㉑ x 4	㉒ x 1		

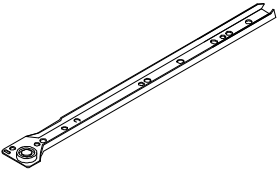
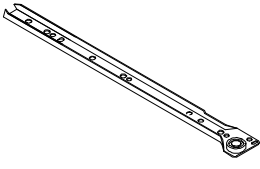
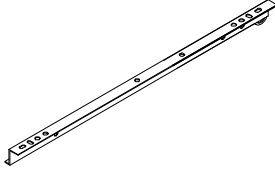
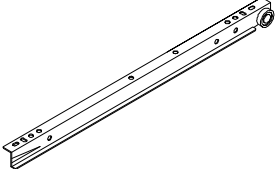
		 Φ 6x30mm	 Φ 4x35mm
A x56+2	B x56+2	C x22+1	D x22+1
 Φ 4x16mm			 Φ 4x12mm
E x6	F x6	G x2	H x2
	 Φ 4x25mm		 Φ 3x14mm
I x2	J x10+1	K x16+1	L x16+1
	 Φ 4x14mm		 Φ 3.5x12mm
M x4	N x24+1	O x8+1	P x32+1
			
CLx4	CRx4	DRx4	DLx4

Step 1

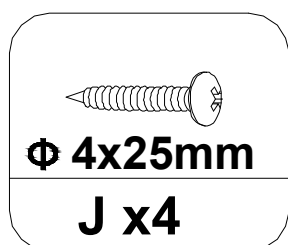
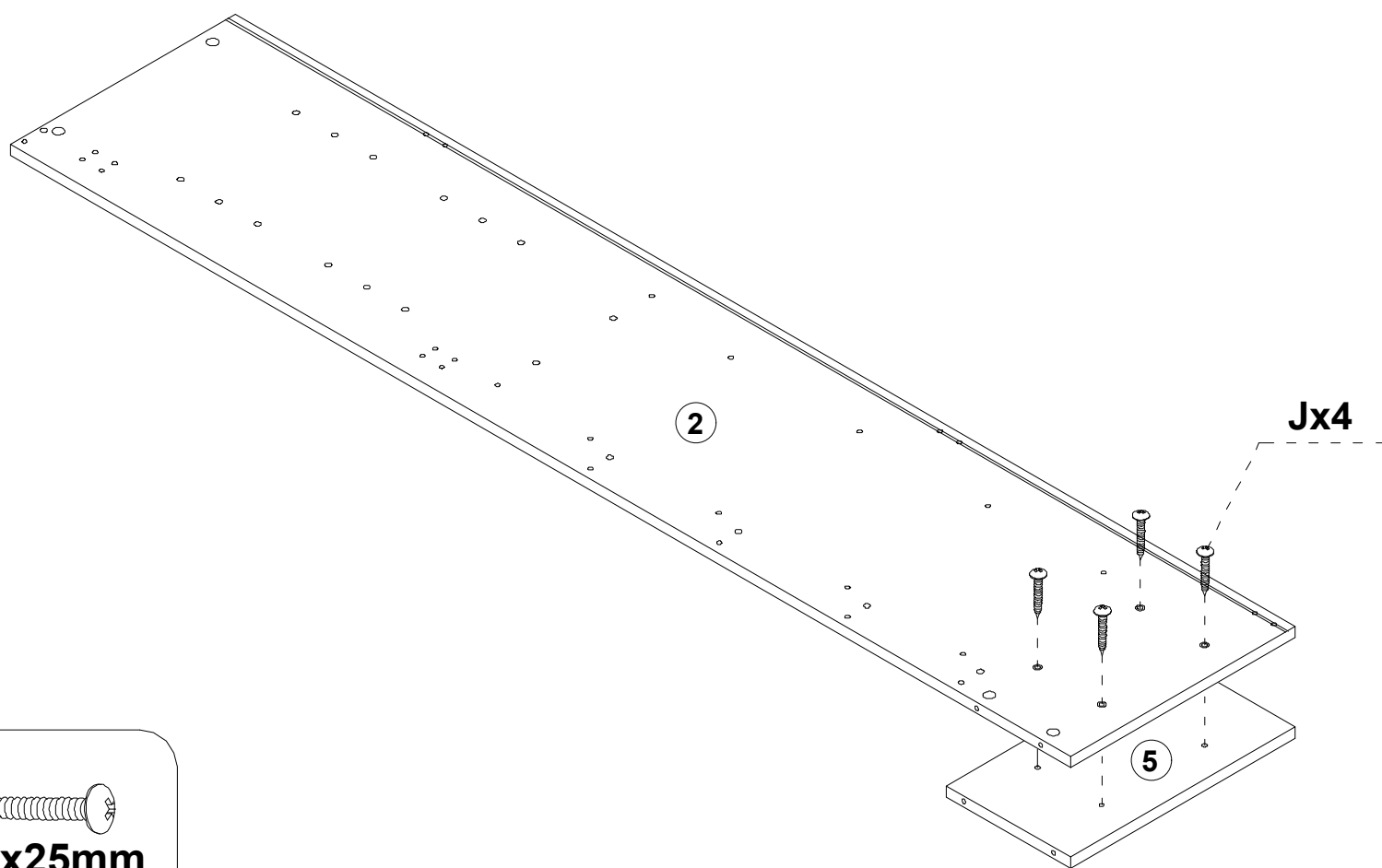

Step 2

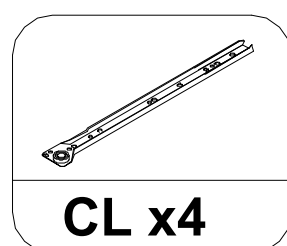
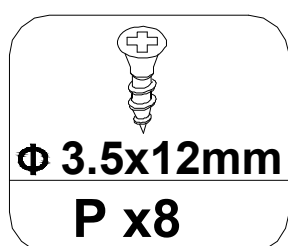
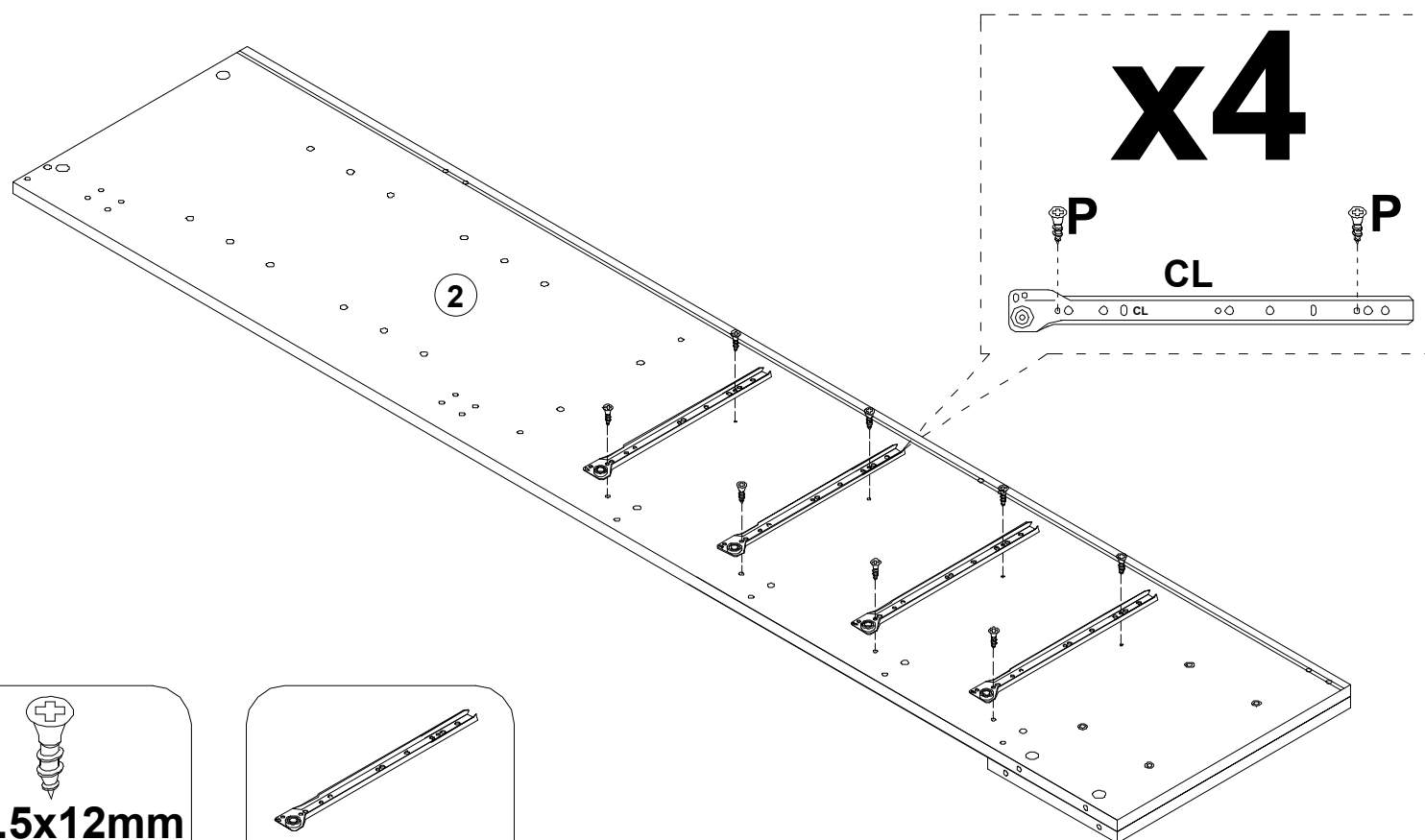

Step 3

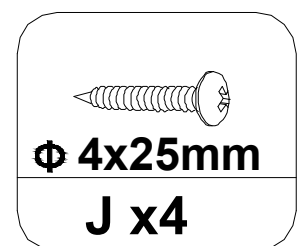
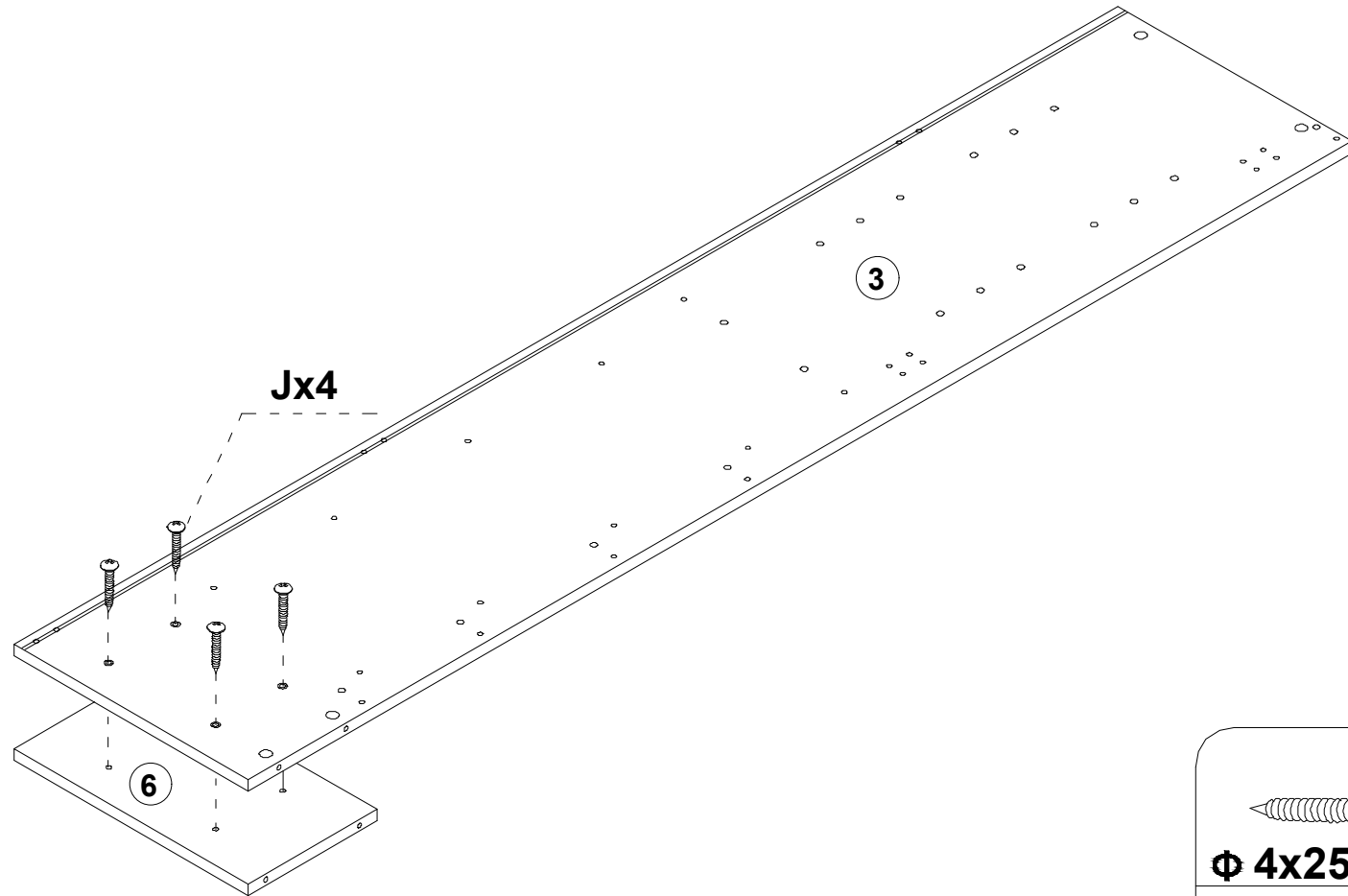

Step 4

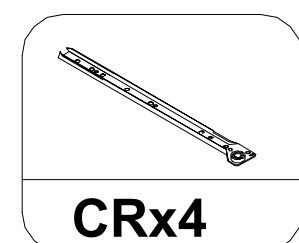
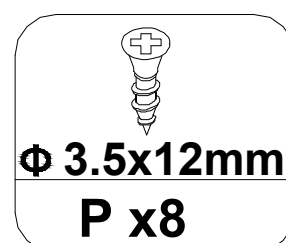
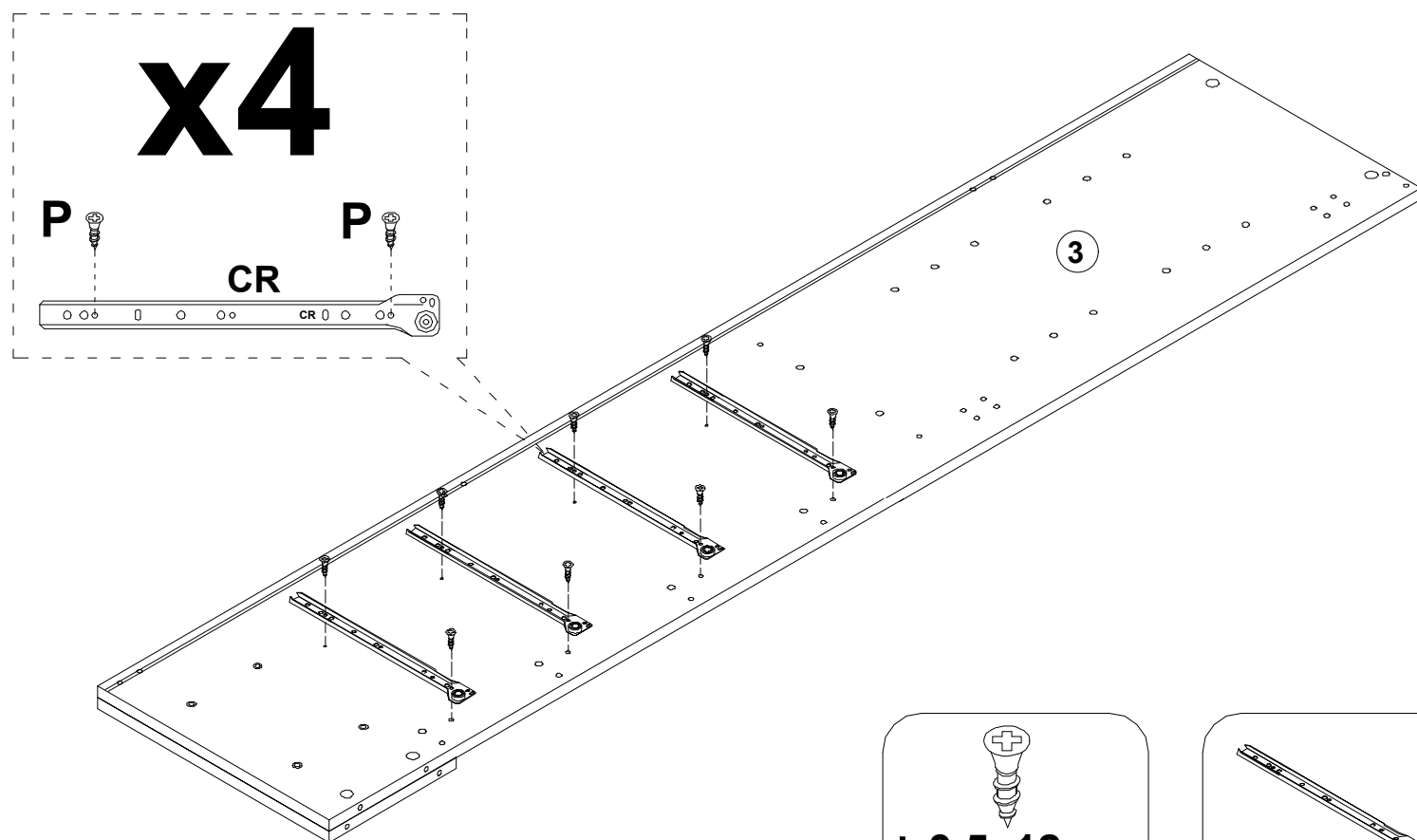

Step 5

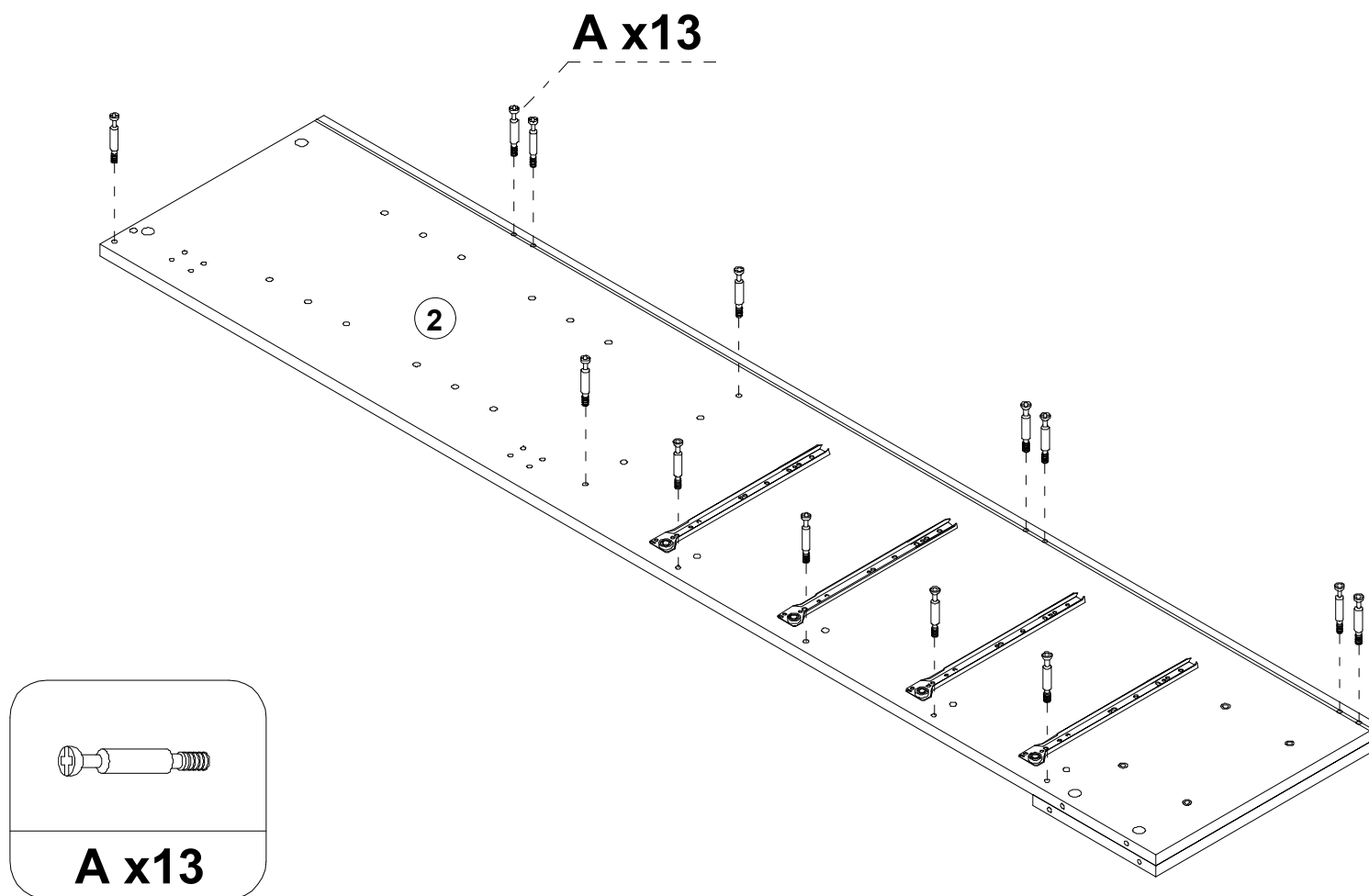

Step 6

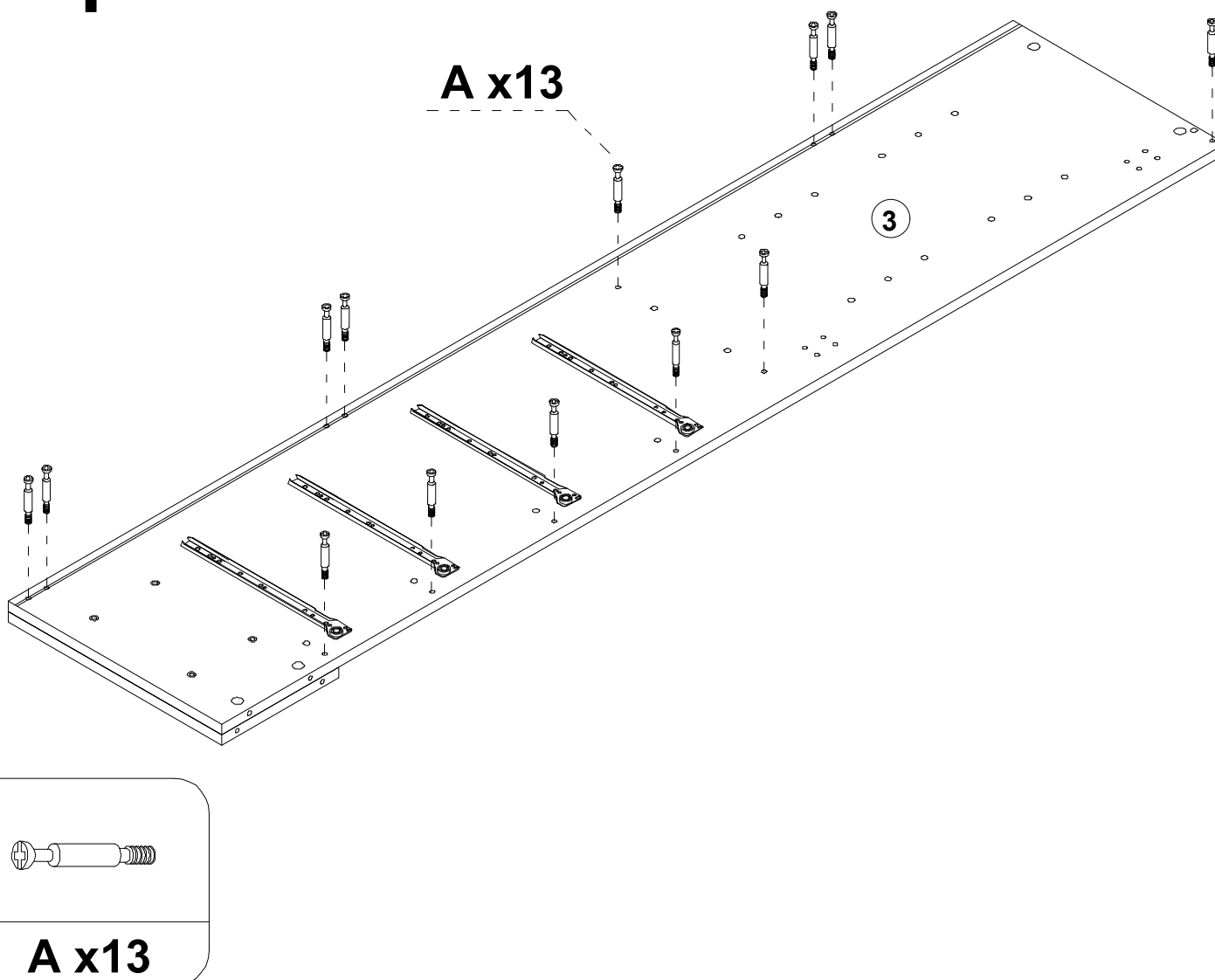

Step 7

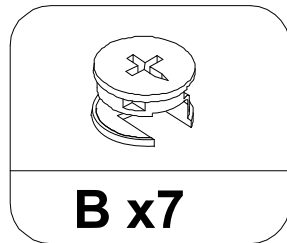
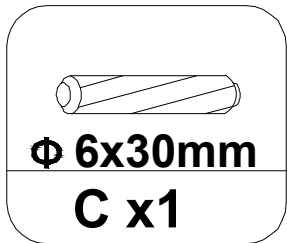
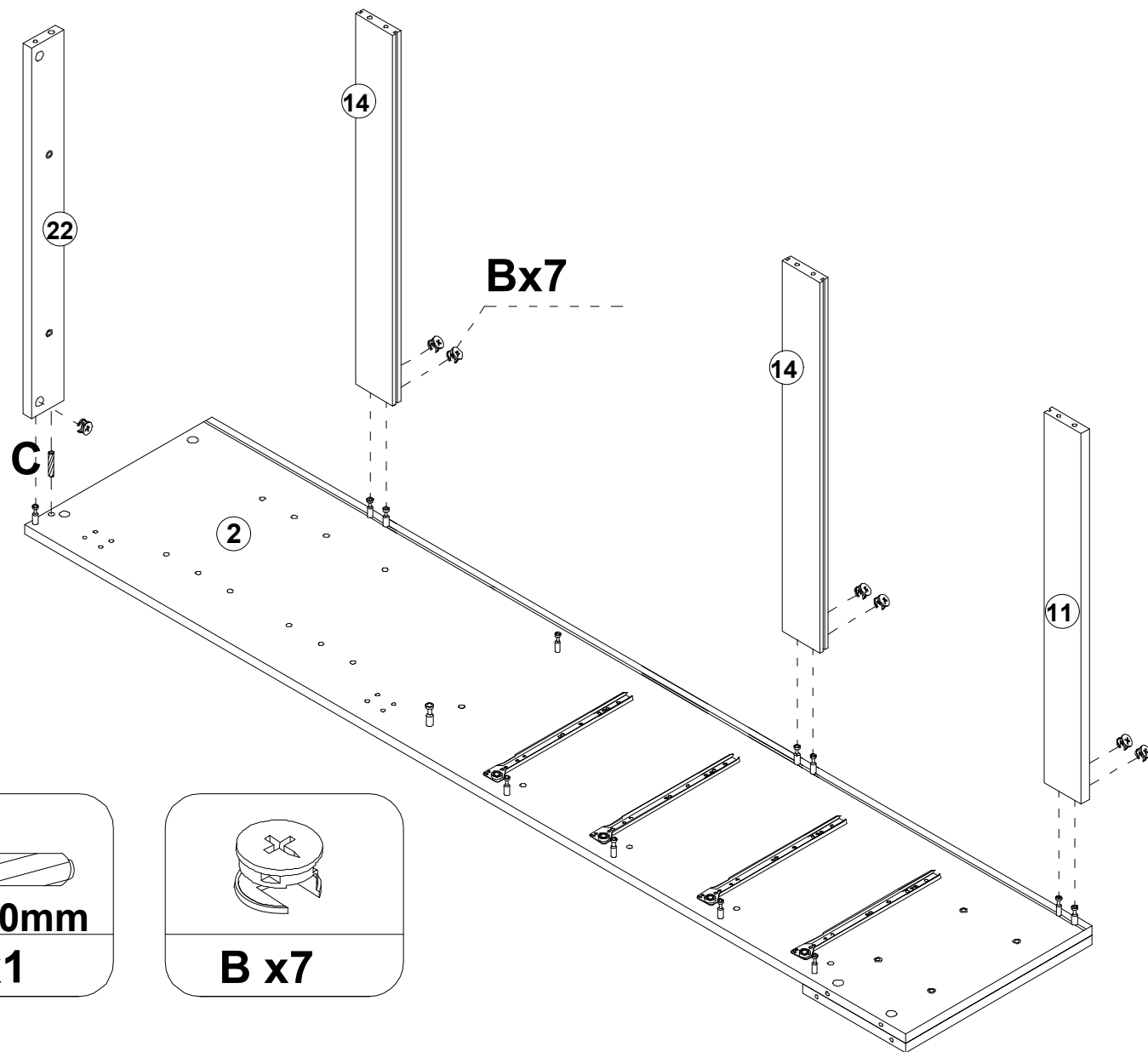

Step 8

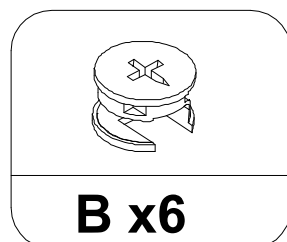
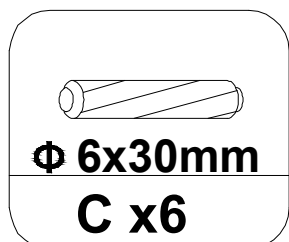
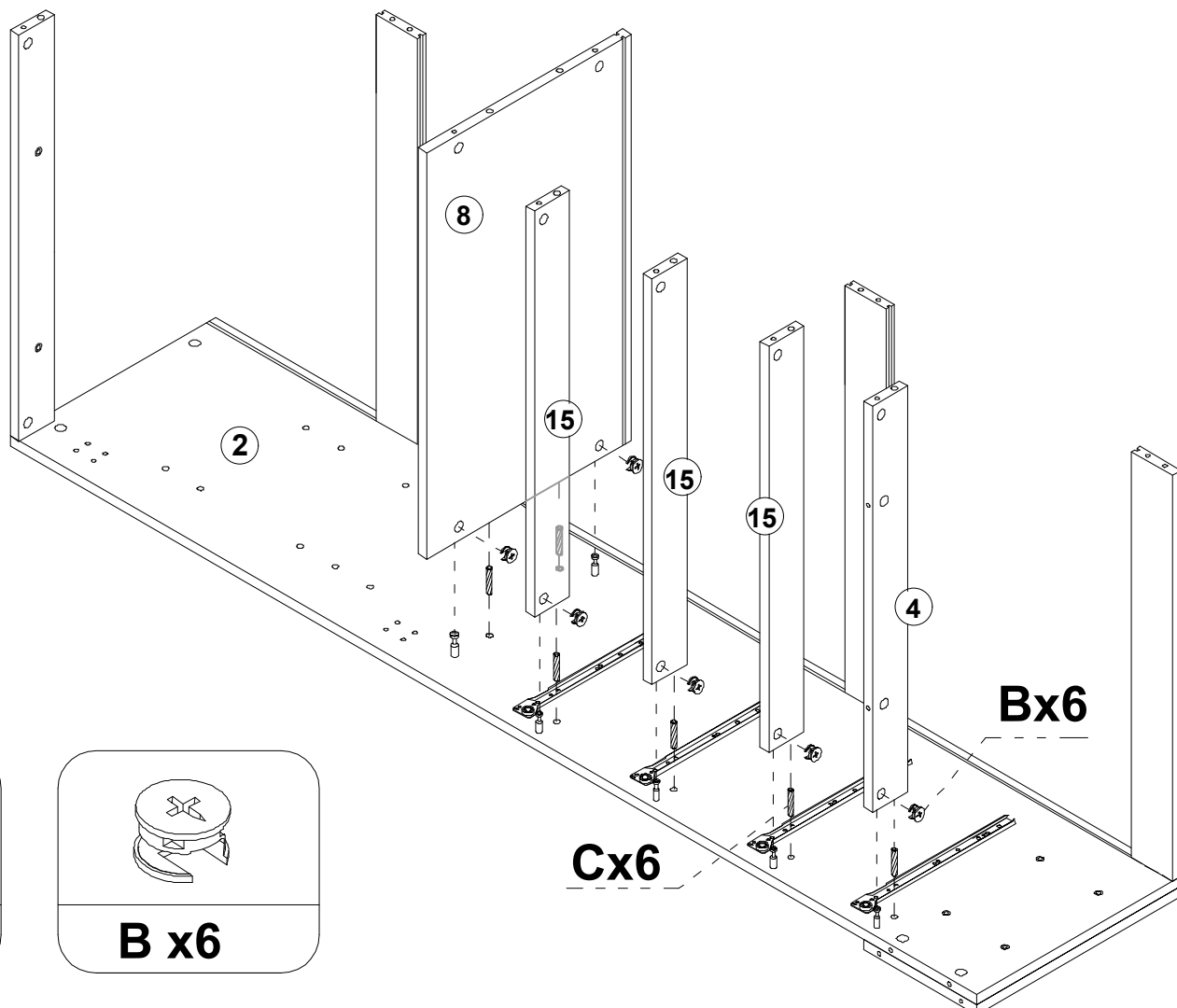

Step 9

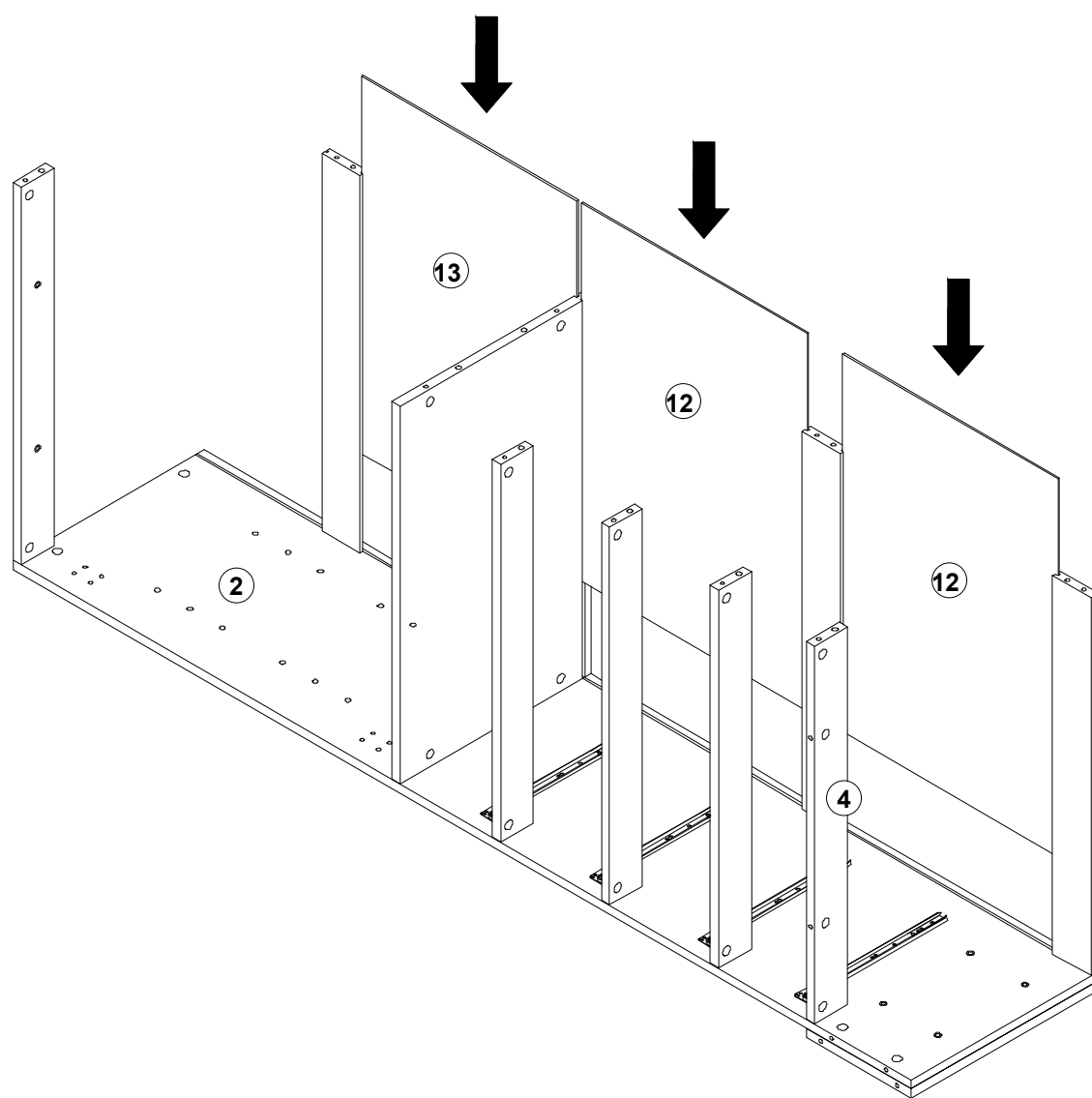

Step 10

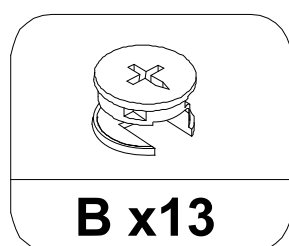
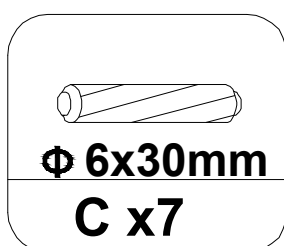
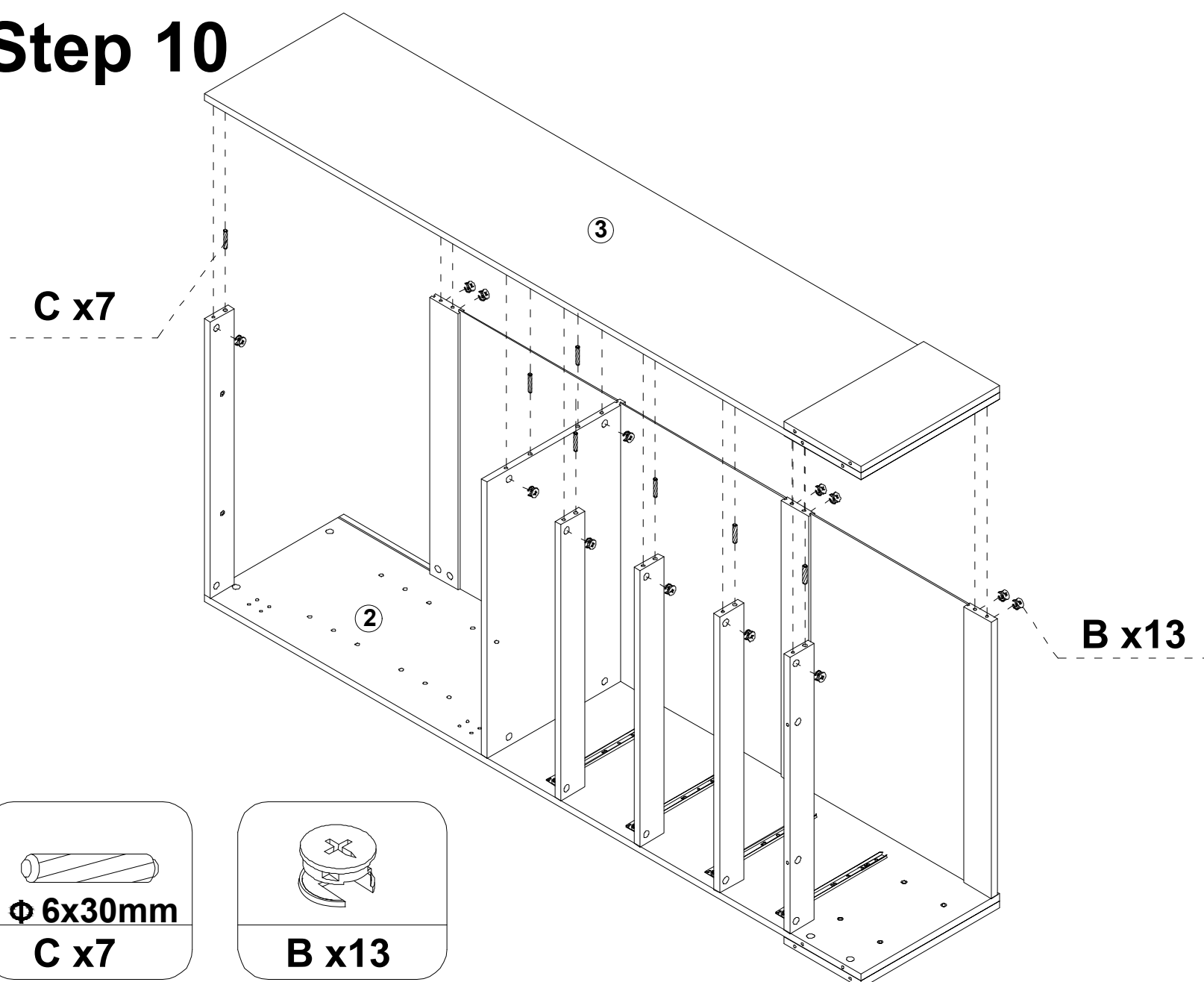

Step 11

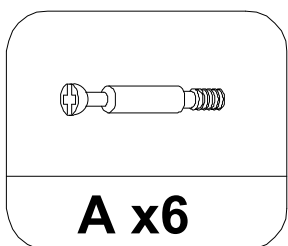
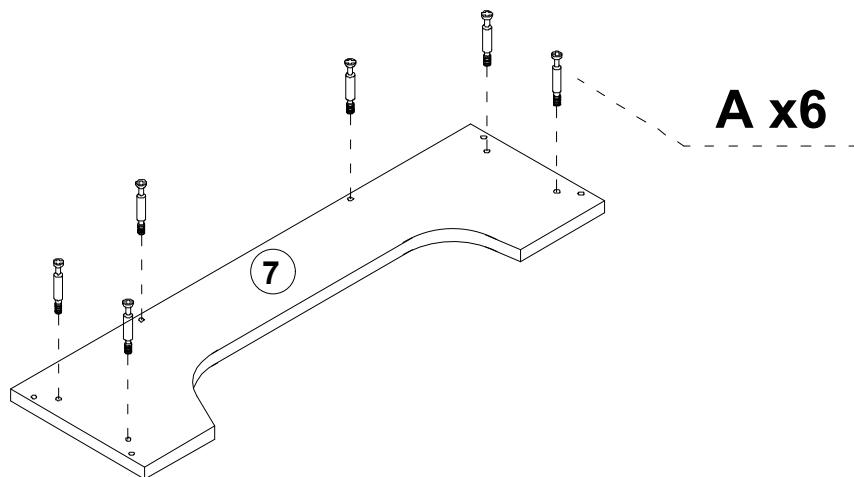

Step 12

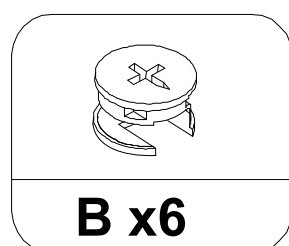
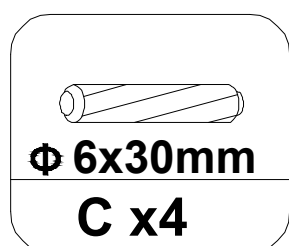
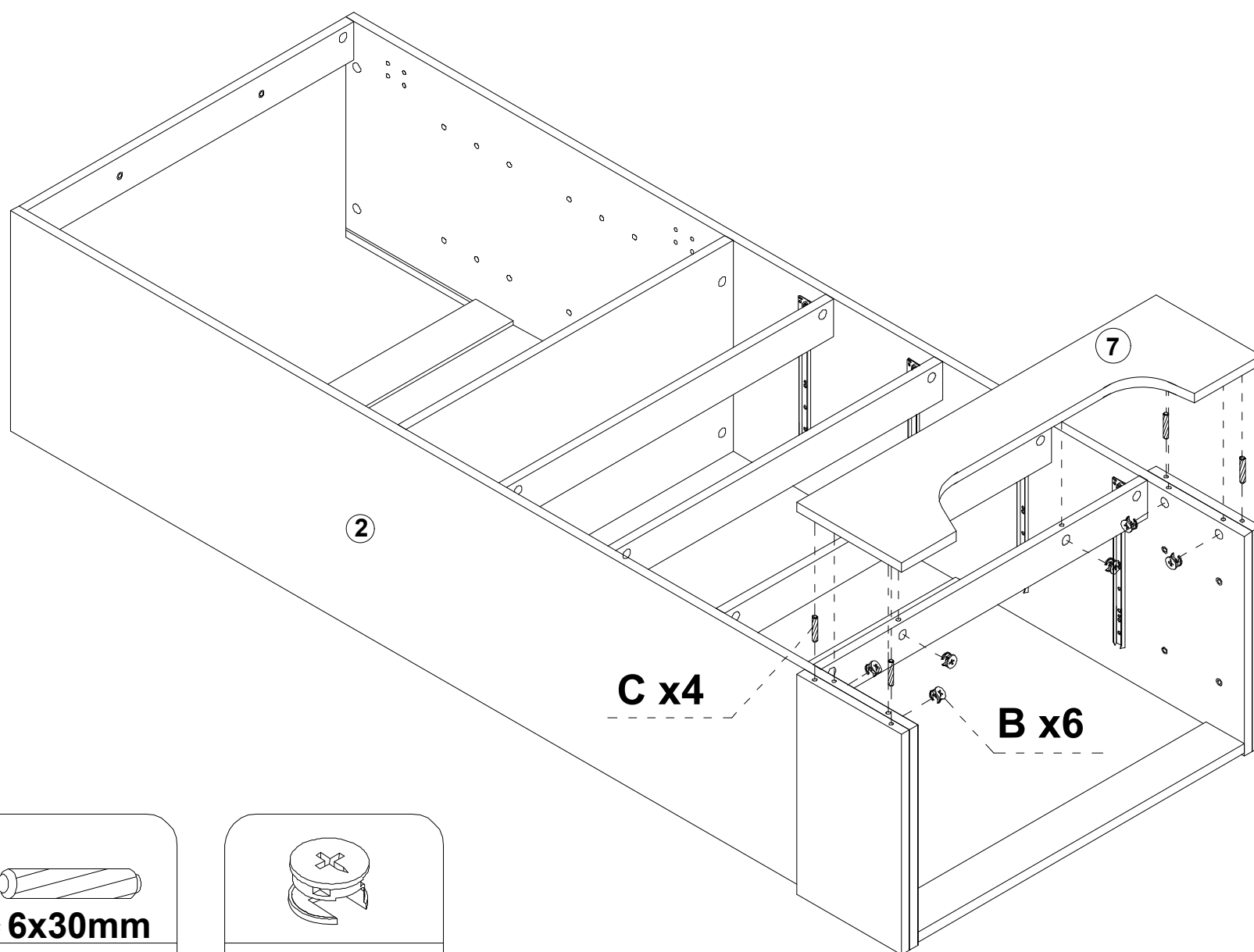

Step 13

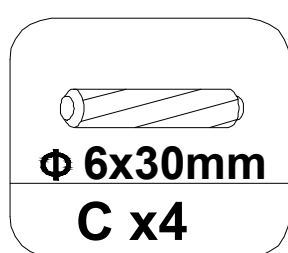
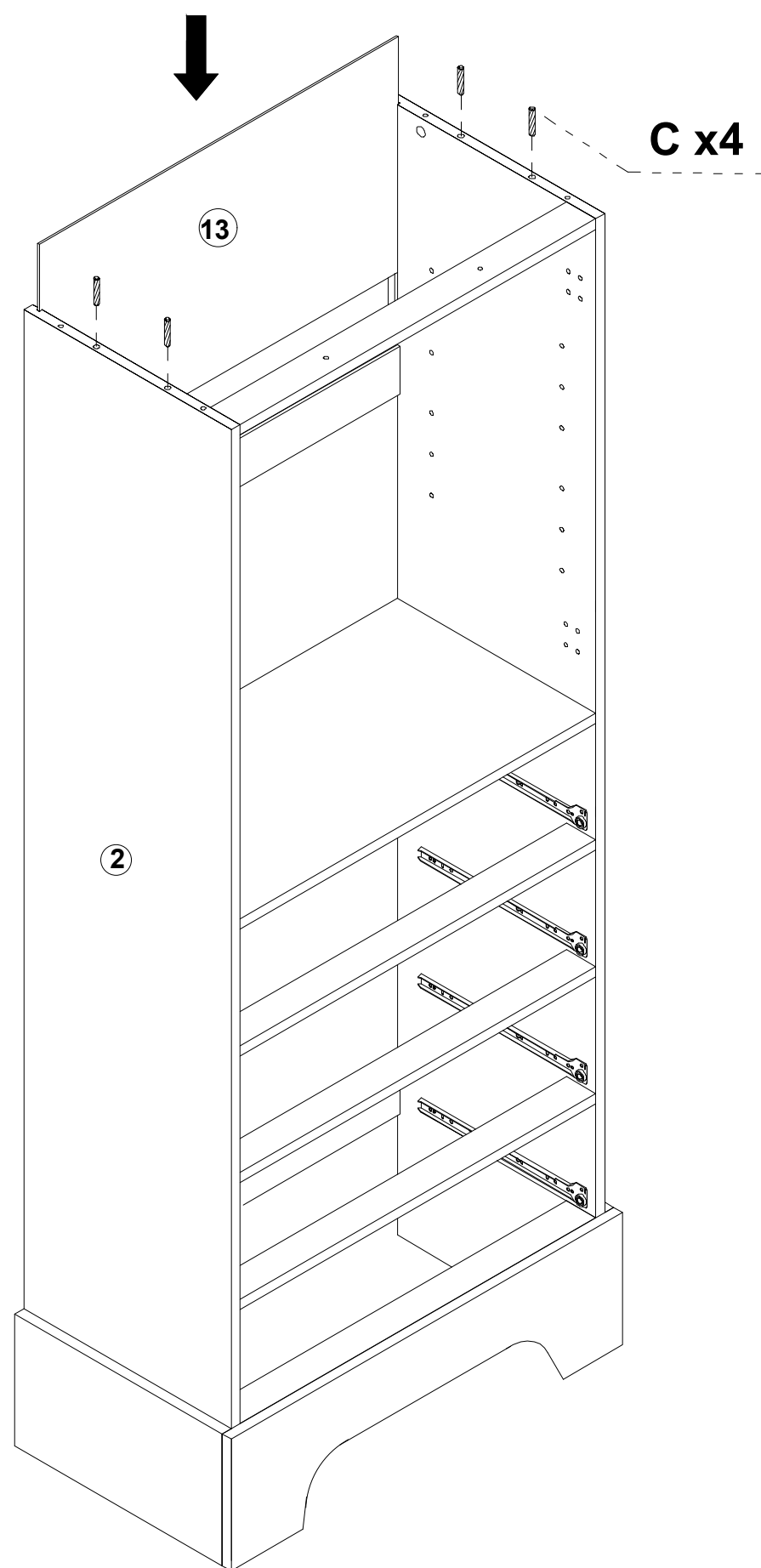

Step 14

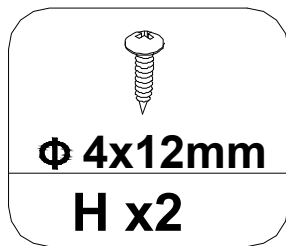
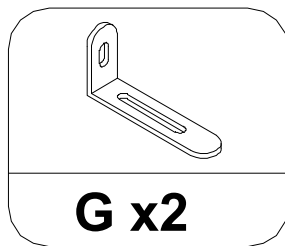
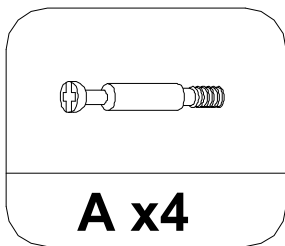
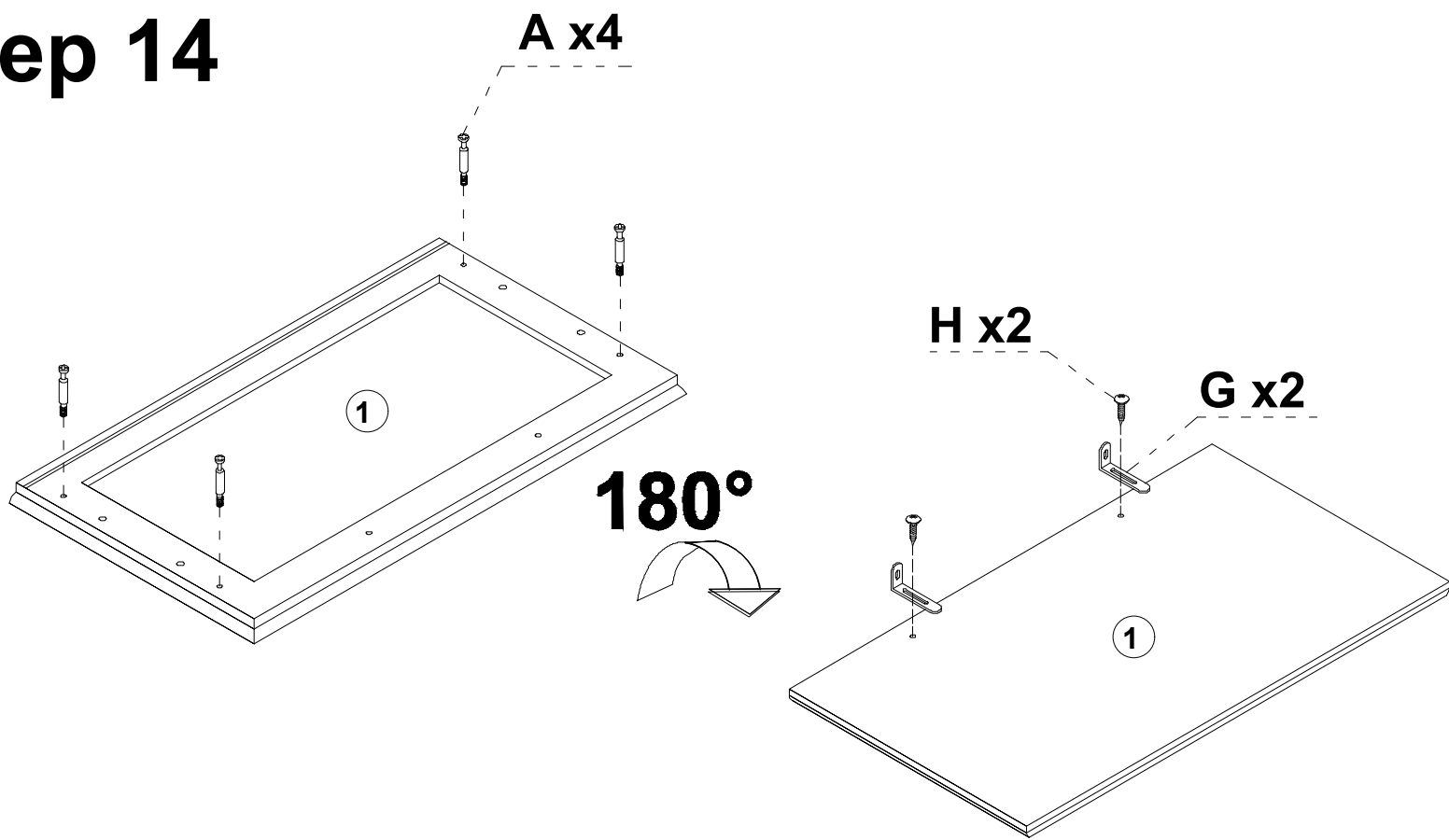

Step 15

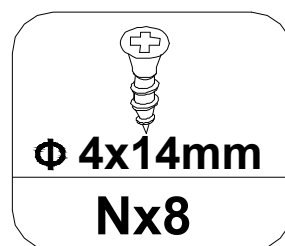
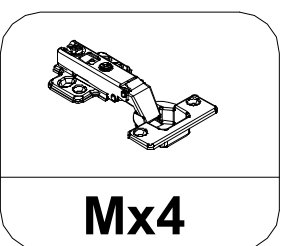
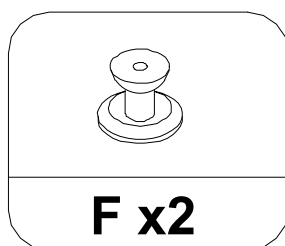
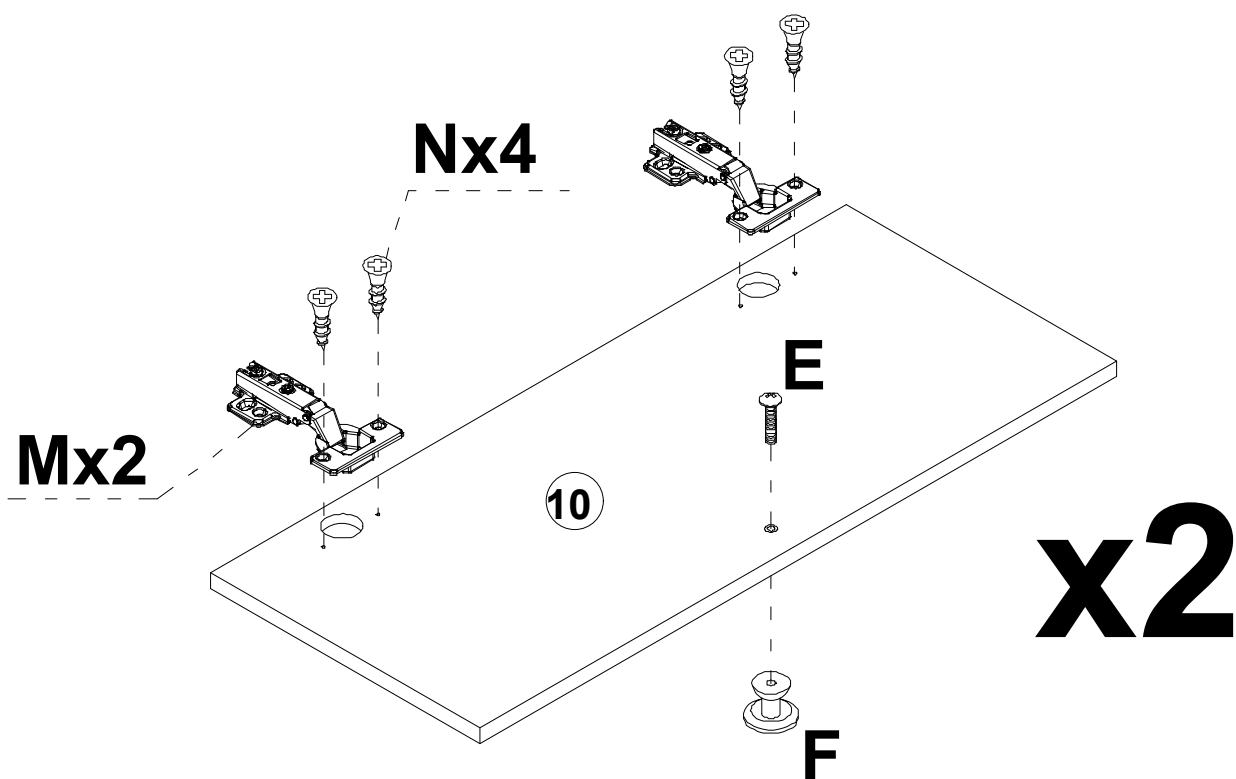

Step 16

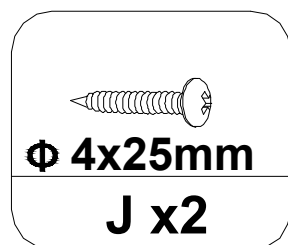
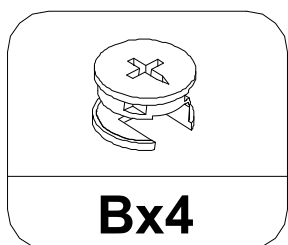
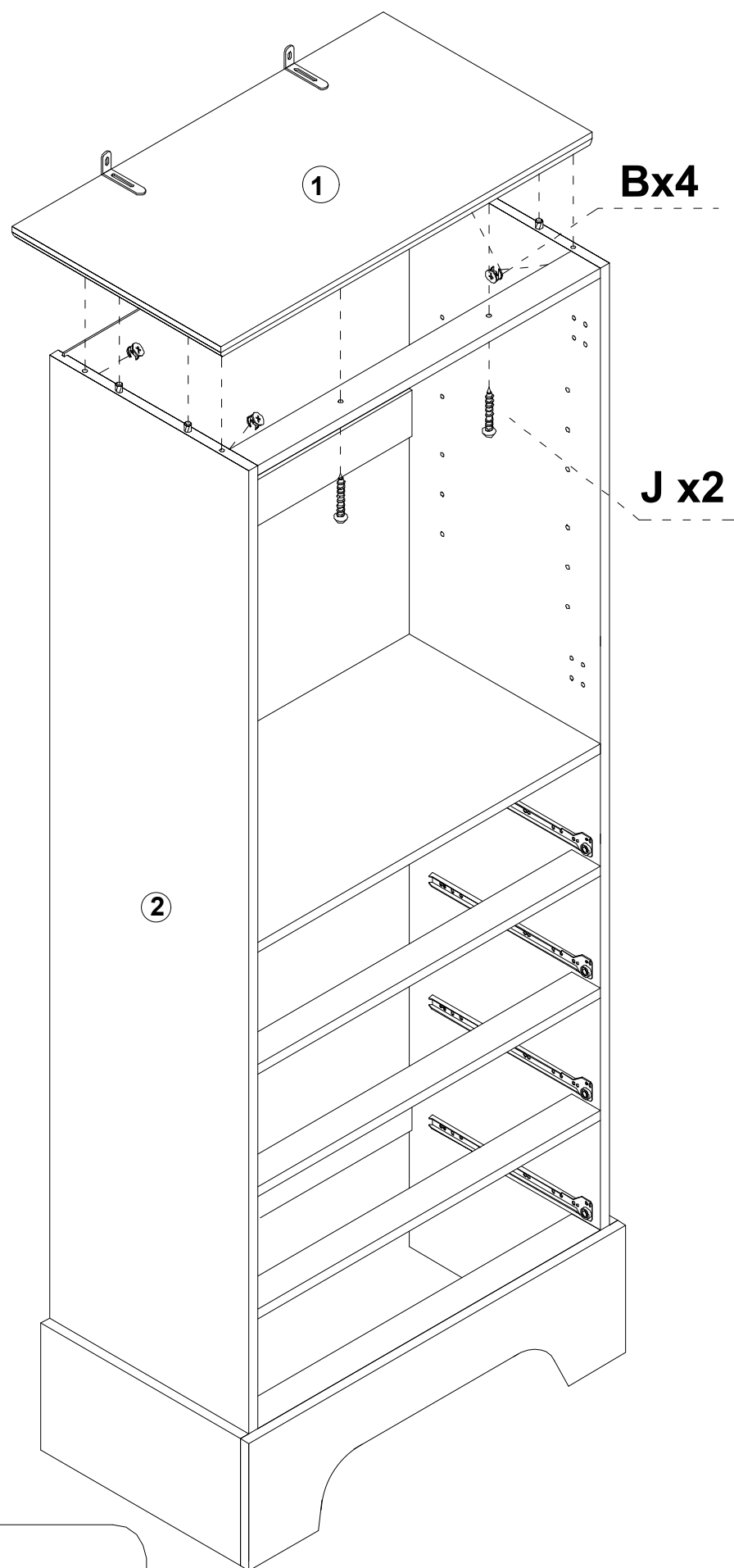

Step 17

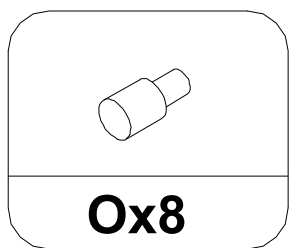
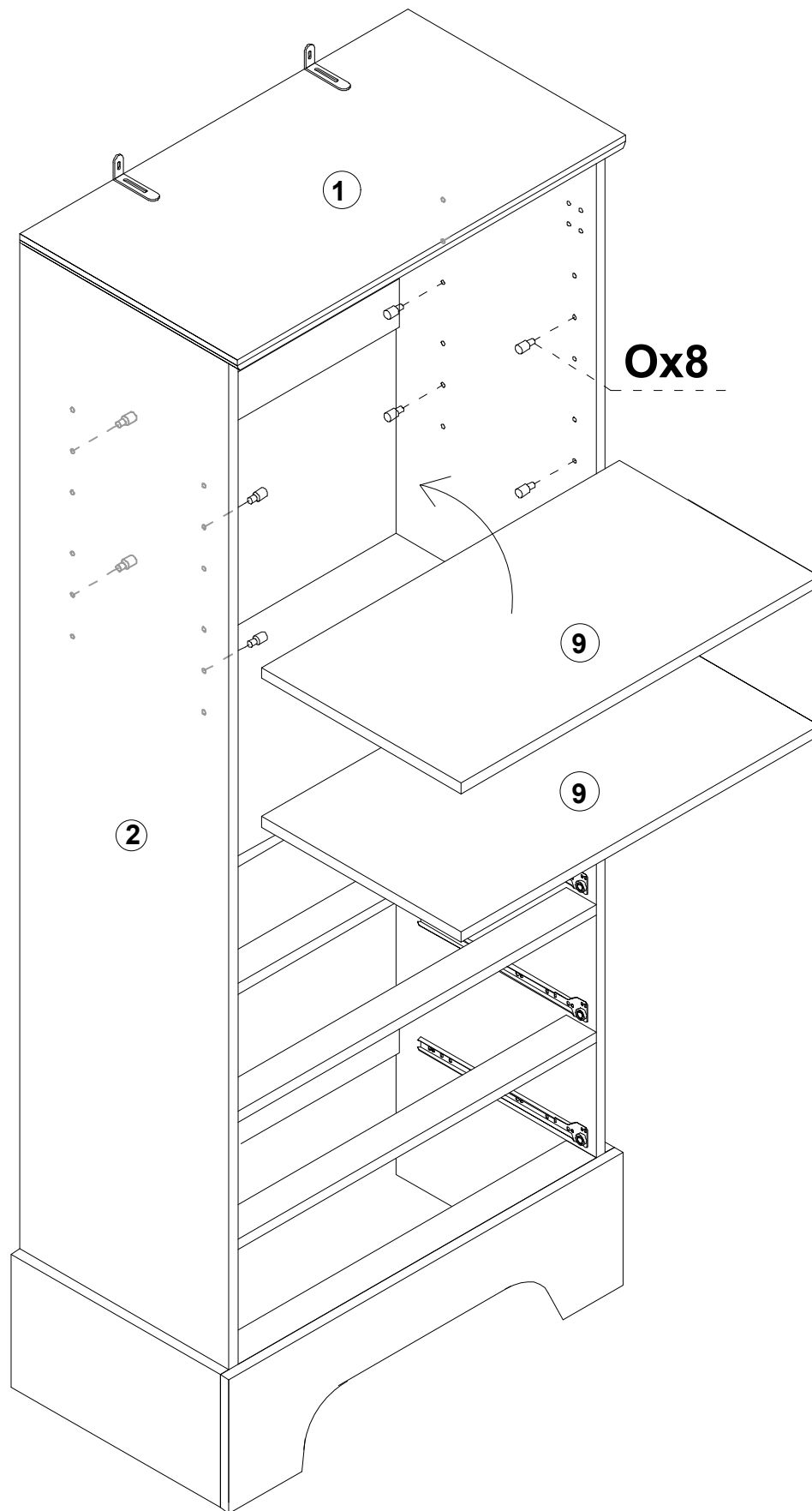

Step 18

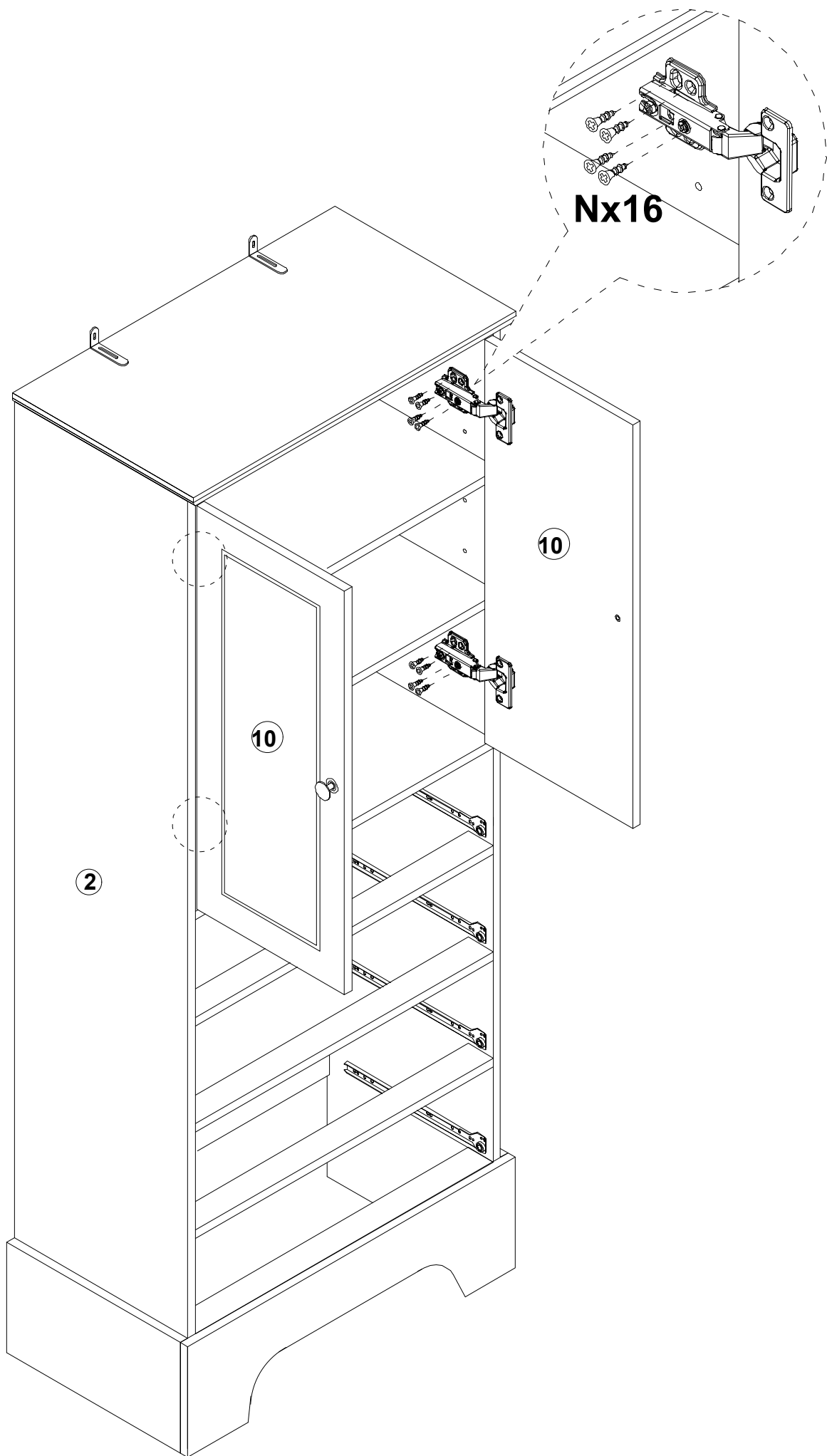
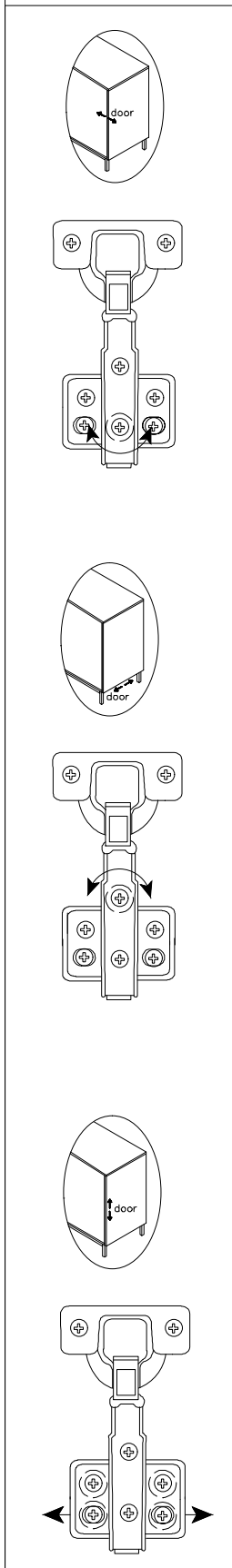

Step 19

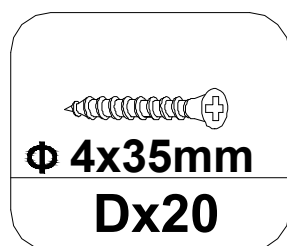
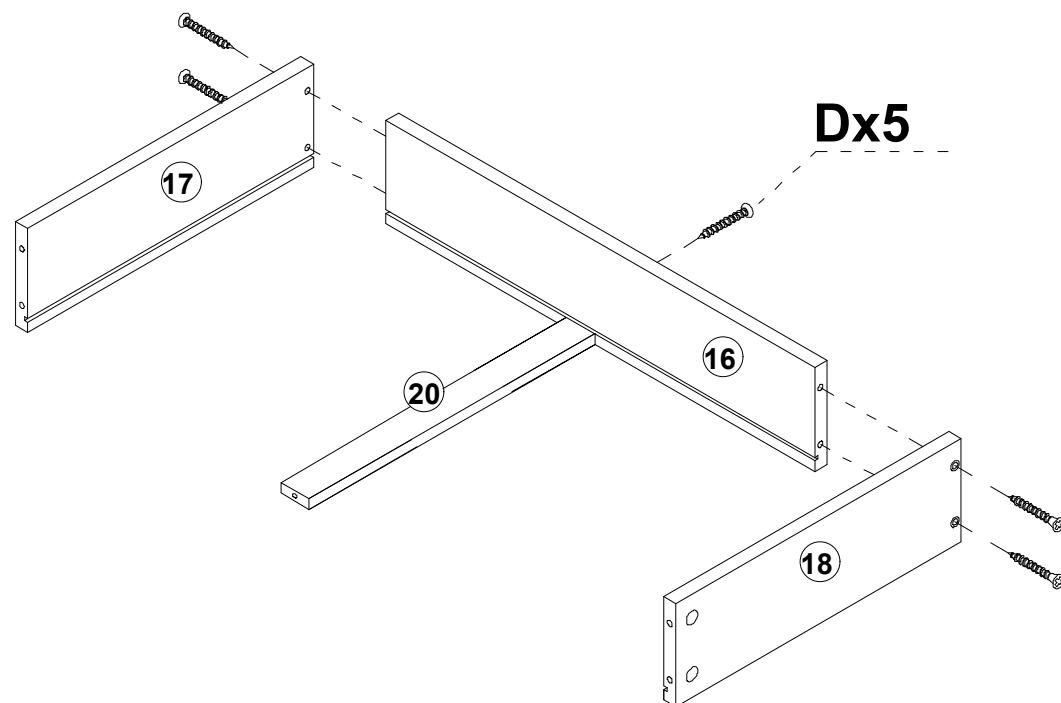

Step 20

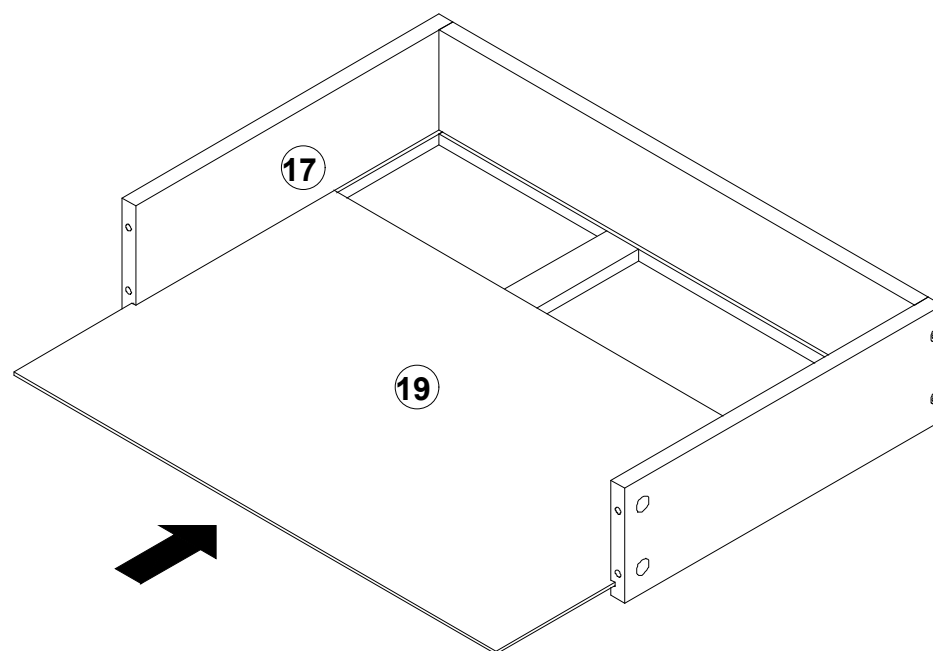

Step 21

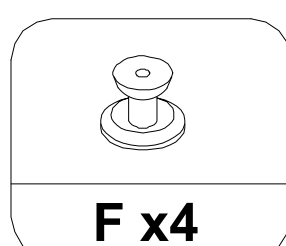
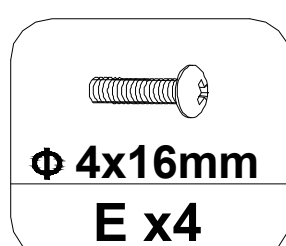
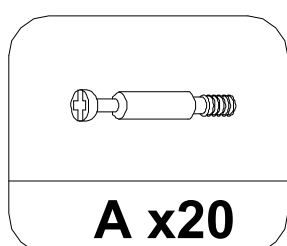
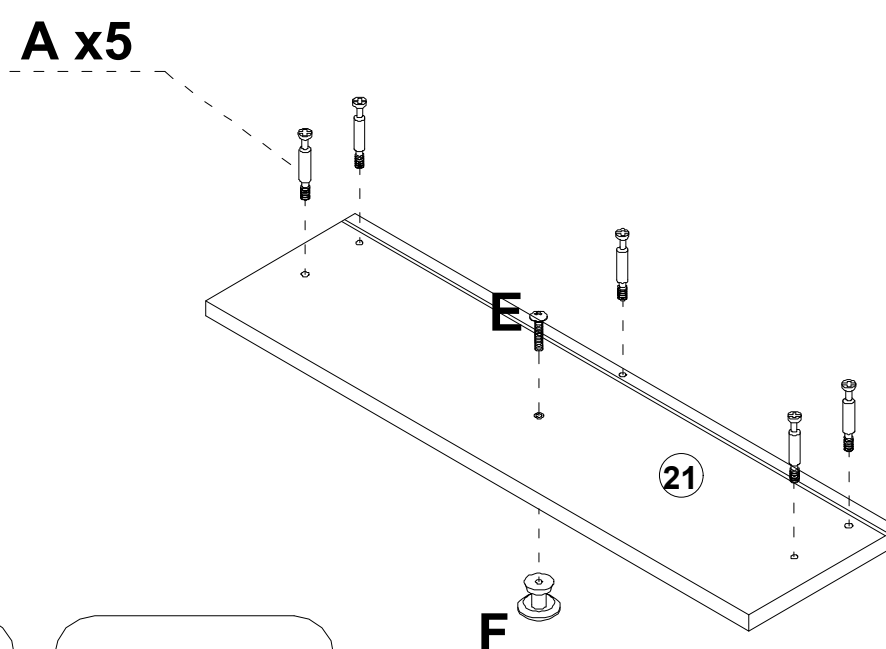

x4

Step 22

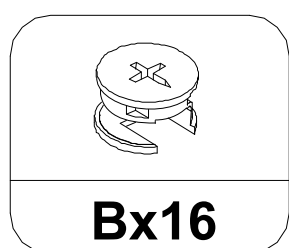
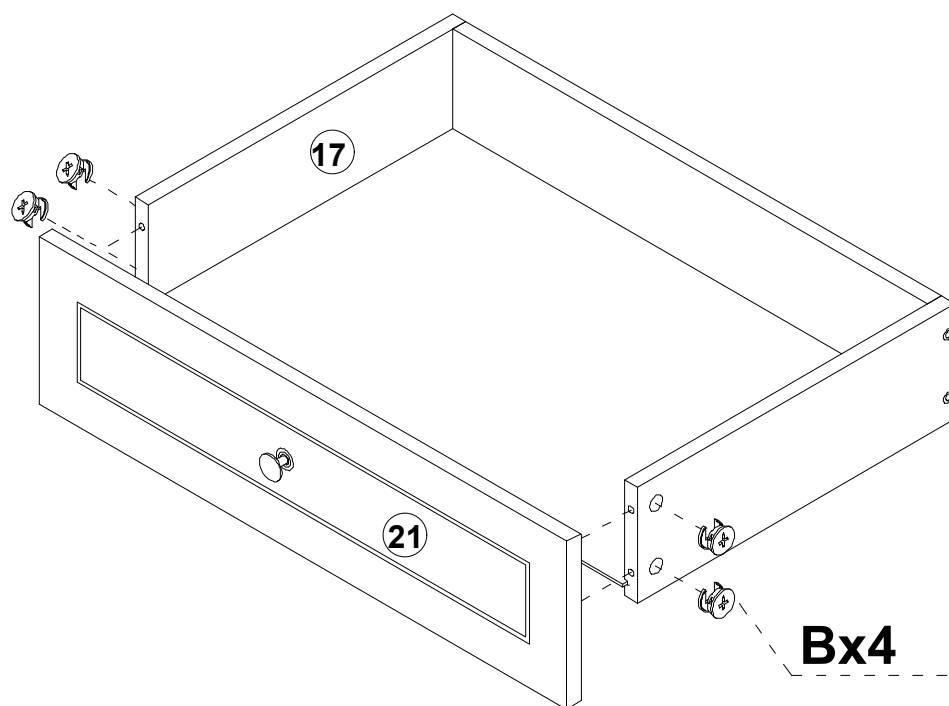

Bx16

x4

Step 23

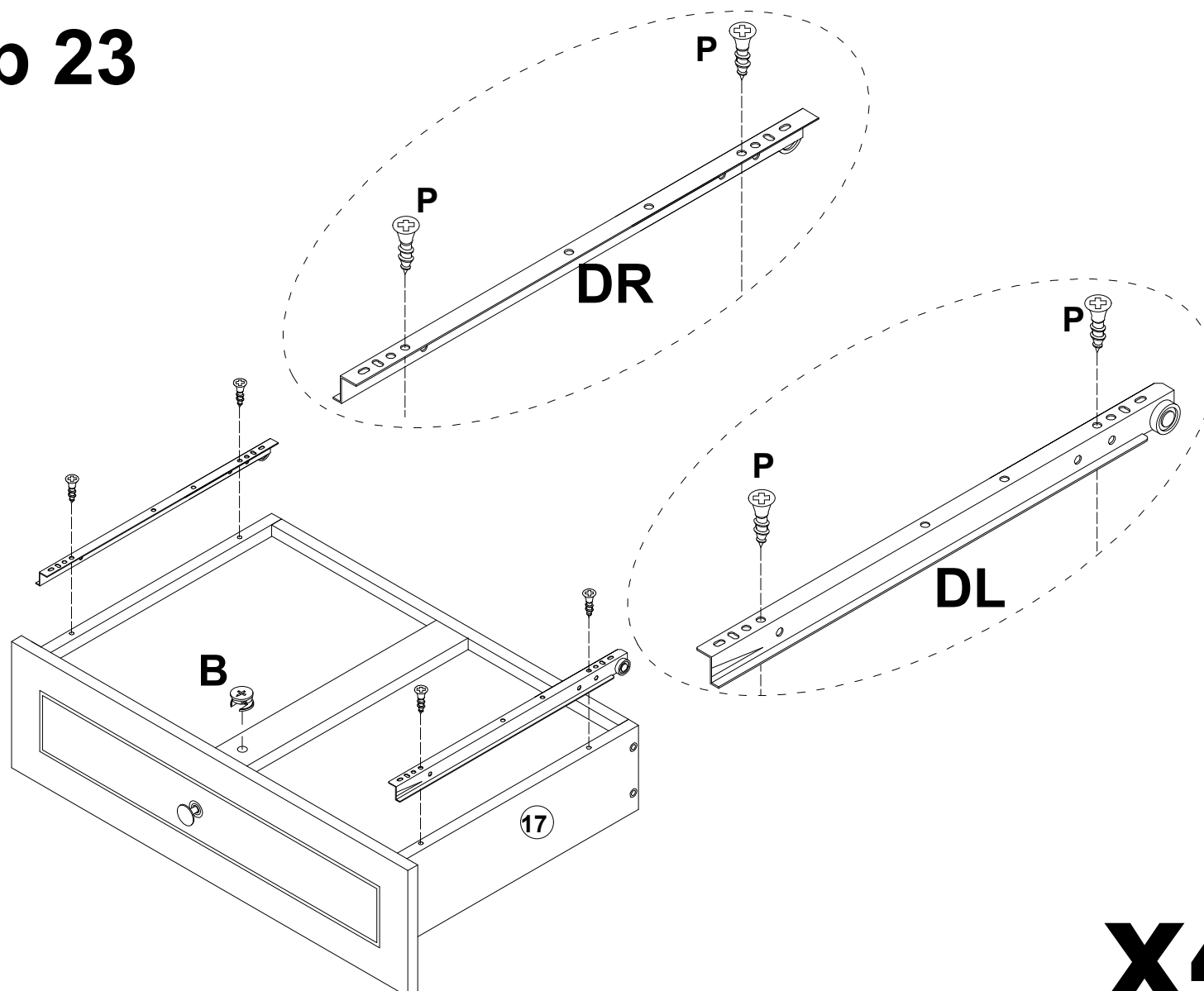

x4

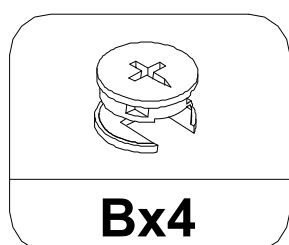

Bx4

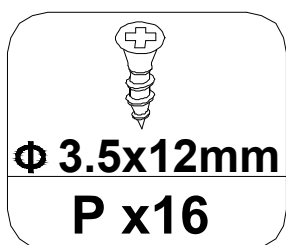

Φ 3.5x12mm
P x16

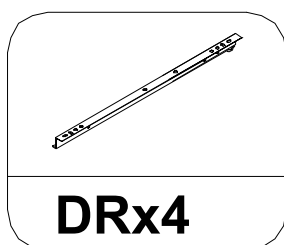

DRx4

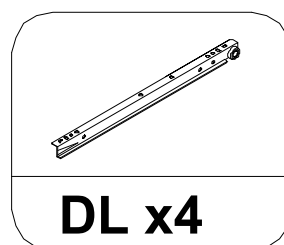

DL x4

Step 25

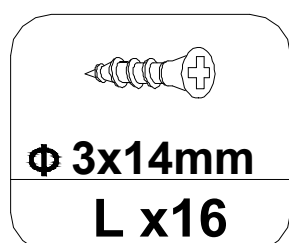
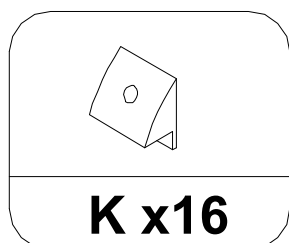
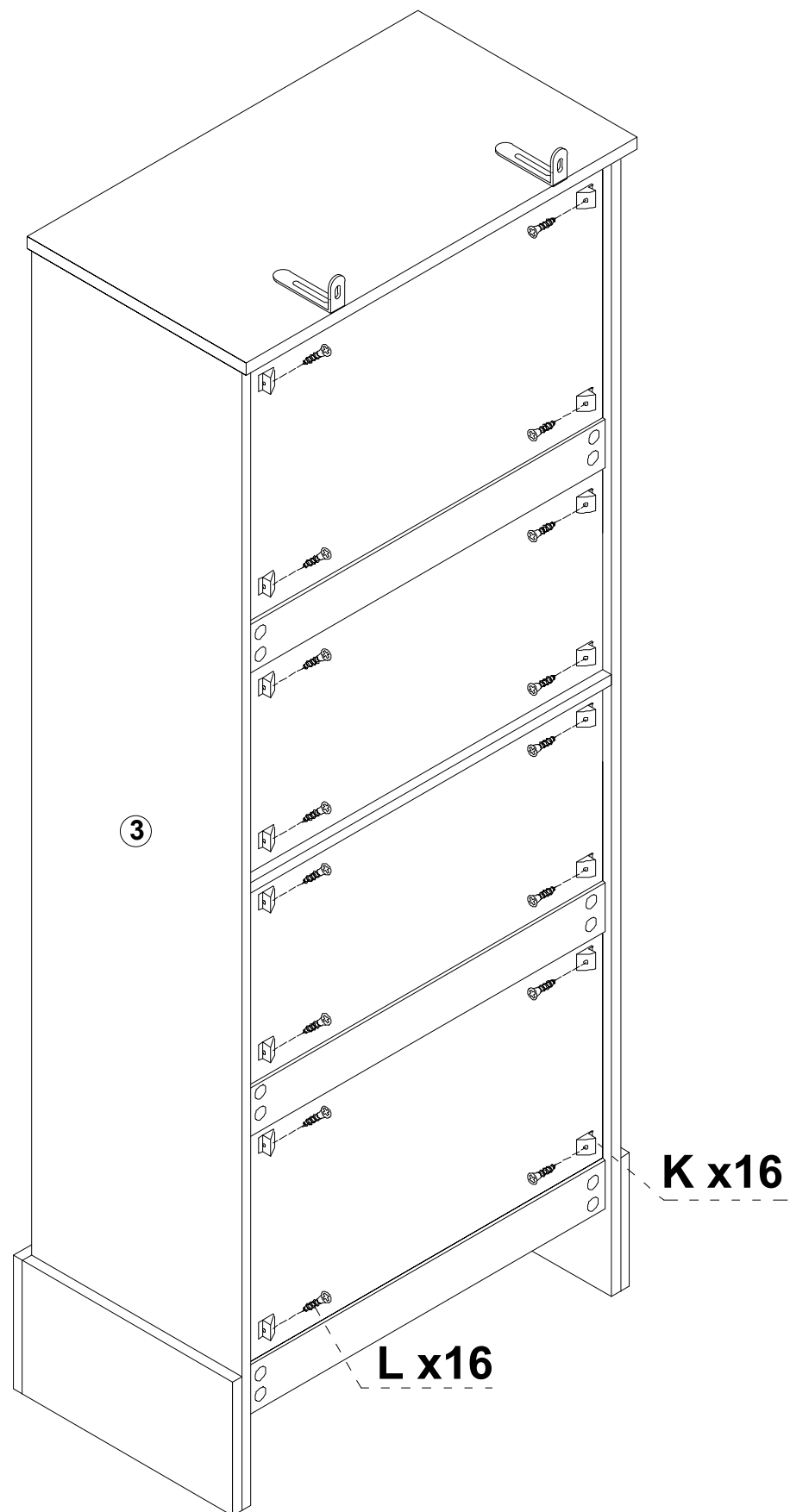

Step 26

