

ENTERTAINMENT CONSOLE

Assembly Instruction

A. Components :

1. 68" Entertainment Console

Qty
1x



a



b



c



d



e

B. Hardware :

a. Screw ø8 x 2" 1 x

b. Screw ø8 x 5/8" 1 x

c. Restrain Strap 1 x

d. Metal Tabs 2 x

e. Plastic Wall Anchor 1 x

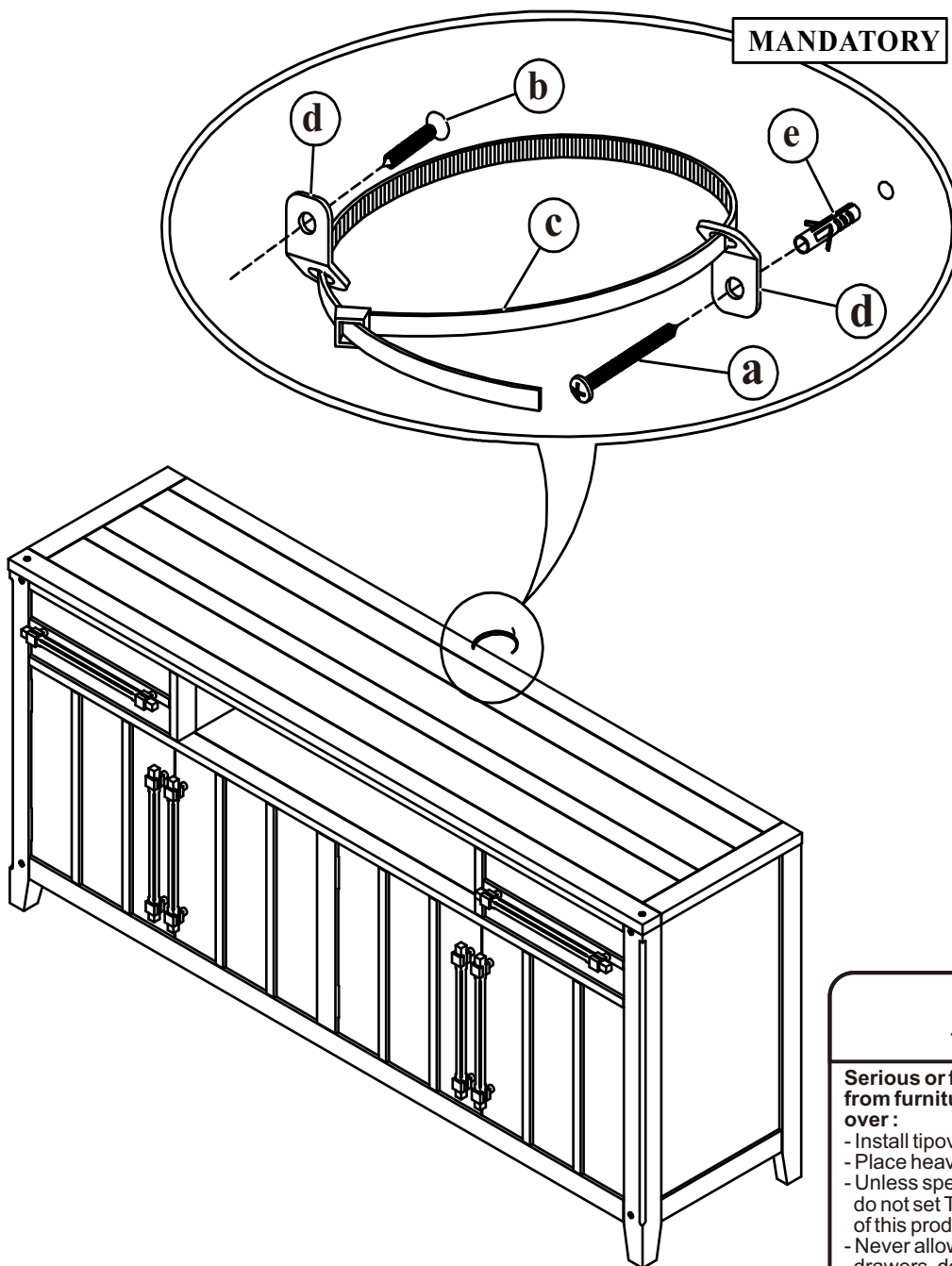

⚠ WARNING

Serious or fatal crushing injuries can occur from furniture tipover. To help prevent tip-over :

- Install tipover restraint provided.
- Place heaviest items in the lowest drawers.
- Unless specifically designed to accommodate, do not set Tv's or other heavy objects on top of this product.
- Never allow children to climb or hang on drawers, doors or shelves.
- Never open more than one drawer at a time.
- (OR)
- Do not defeat or remove the drawer interlock system.

Use of tip over restraints may only reduce, but not eliminate the risk of tip-over.

This is a permanent label. Do not attempt to remove.