

BED ASSEMBLY INSTRUCTIONS

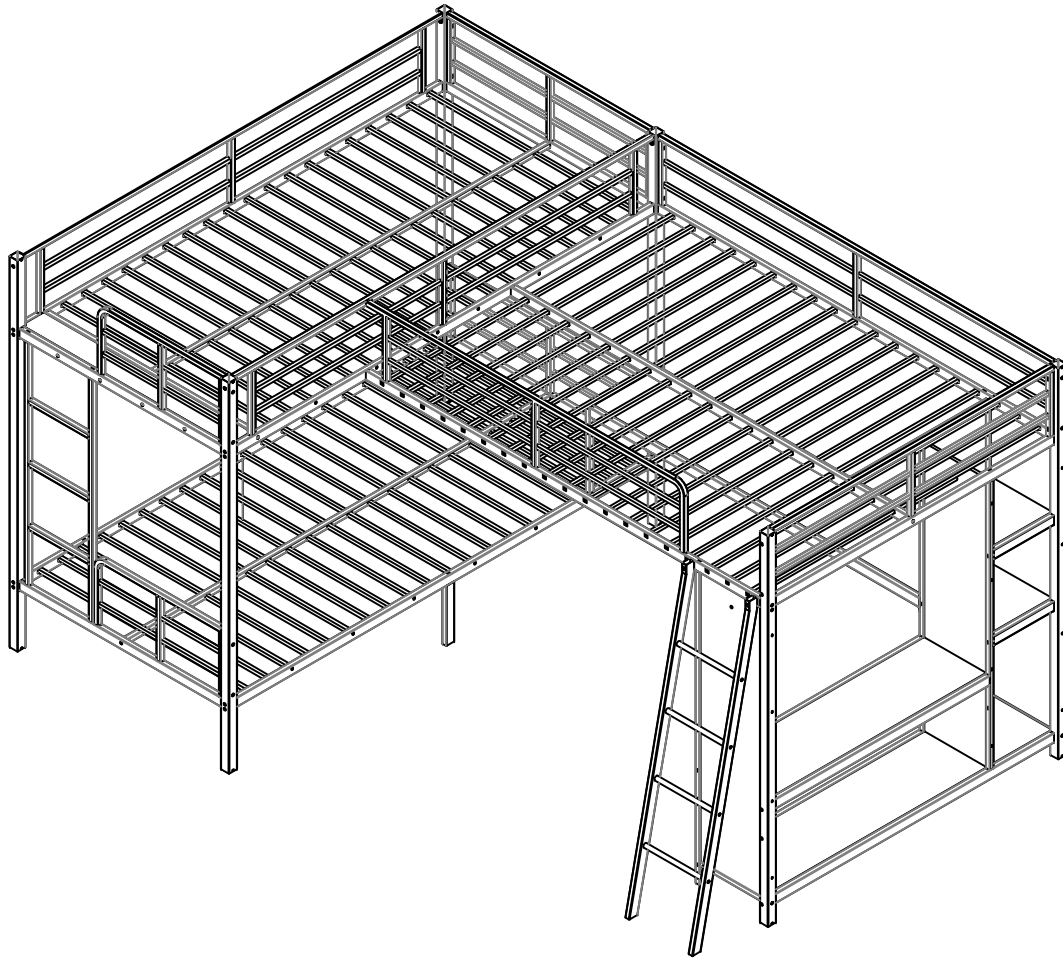

SAFETY WARNINGS AND GENERAL NOTES:

1. Follow the information on the warnings on the bunk bed end structure and on the carton. Do not remove the warning label from the bed.
2. Always use the recommended size mattress on mattress support, or both, to help prevent the likelihood of entrapment or falls.
3. Do not allow children under 6 years of age to use the upper bunk.
4. Periodically check and ensure the guardrail, ladder and other components are in their proper position, free from damage, and all connectors are tight.
5. Do not allow horseplay on or under beds.
6. Always prohibit jumping on the bed.
7. Prohibit more than one person on upper bunk.
8. Always use the ladder for entering and leaving the upper bunk.
9. Do not use substitute parts. Contact the manufacturer or dealer for replacement parts.
10. Use of a night-tight may provide added safety precaution for a child using the upper bunk.

11. Always use guardrails on both long sides of the upper bunk.
12. If the bunk bed will be placed next to a wall, the guardrail that runs the full length of the bed should be placed against the wall to prevent entrapment between the bed and the wall.

The use of water or sleep flotation mattresses is prohibited.

13. **STRANGULATION HAZARD**-Never attach or hang items to any part of the bunk bed that are not designed for use with the bed; for example, but not limited to, hooks, belts and jump ropes.
14. Keep these instructions for future reference.
15. We recommend assembling your bunk bed on the shipping carton to protect your floor or carpet.
16. Be certain all staples are out of the box before beginning assembly on the shipping carton.
17. **USE ONLY MATTRESSES WHICH ARE AS THE TABLE BELOW ON UPPER AND ON LOWER BUNKS.**

Down bed			
Mattress type	Length	Width	Thickness
TWIN XL Standard	79"-80"	38"-39"	8"
Up bed (bunk bed and tribed included)			
Mattress size	Length	Width	Thickness
FULL Standard	74"-75"	53"-54"	6"max
TWIN XL Standard	79"-80"	38"-39"	6"max







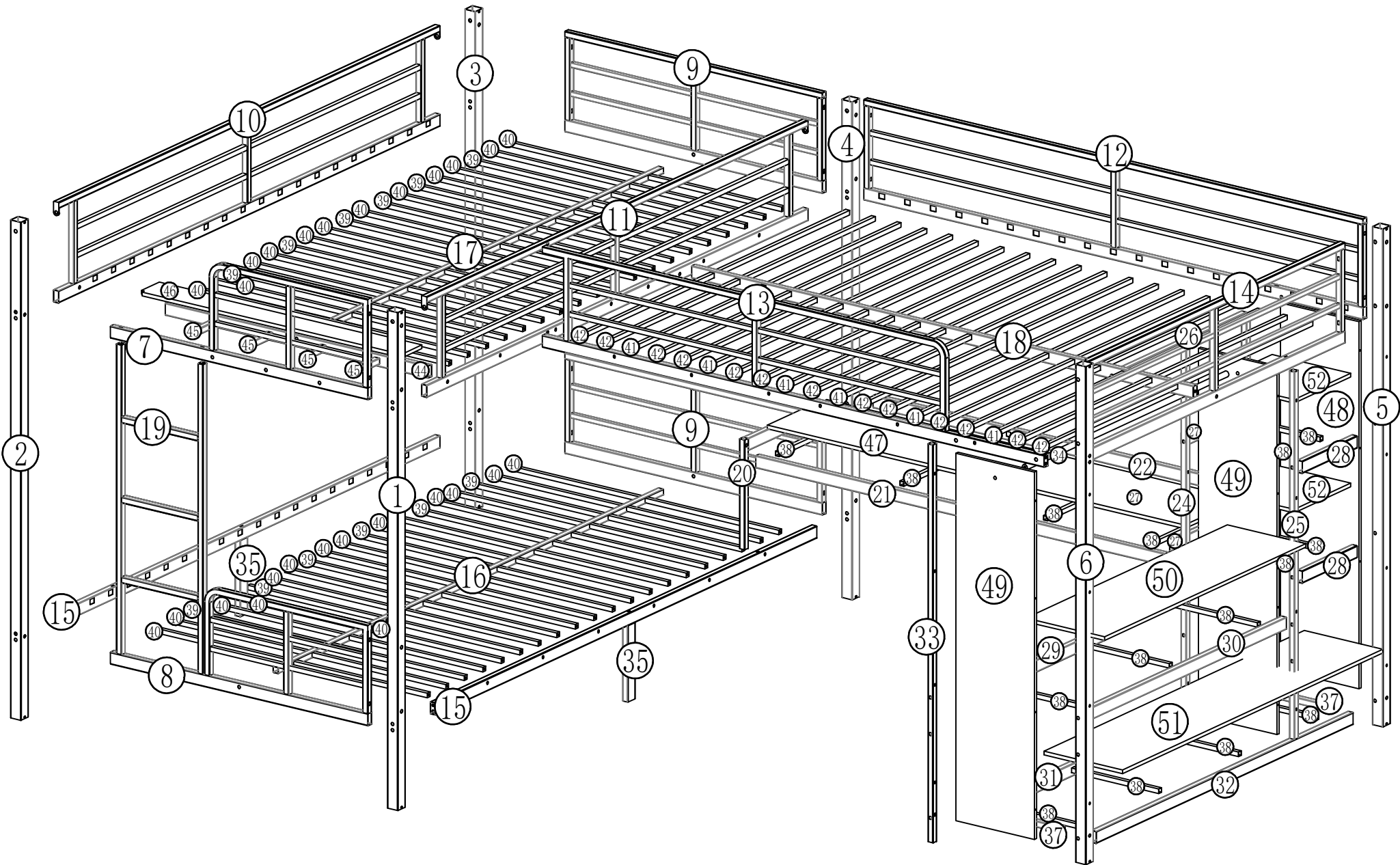













































18. **SURFACE OF MATTRESS MUST BE AT LEAST 5"(127MM) BELOW THE UPPER EDGE OF GUARDRAILS.**

19. Replacement Parts:
Replacement Parts, including additional guardrails, may be obtained from any of our (Shenzhen Yuefeng Zhiqi Technology Co., Ltd) dealers.









Bed parts view



Part List

 1-1pcs	 2-1pcs	 3-1pcs	 4-1pcs	 5-1pcs	 6-1pcs	 7-1pcs
 8-1pcs	 9-2pcs	 10-1pcs	 11-1pcs	 12-1pcs	 13-1pcs	 14-1pcs
 15-2pcs	 16-1pcs	 17-1pcs	 18-1pcs	 19-1pcs	 20-1pcs	 21-1pcs
 22-1pcs	 23-1pcs	 24-1pcs	 25-1pcs	 26-1pcs	 27-2pcs	 28-2pcs
 29-1pcs	 30-1pcs	 31-1pcs	 32-1pcs	 33-1pcs	 34-1pcs	 35-2pcs
 36-4pcs	 37-2pcs	 38-15pcs	 39-12pcs	 40-27pcs	 41-6pcs	 42-13pcs
 43-2pcs	 44-1pcs	 45-4pcs	 46-1pcs	 47-1pcs	 48-1pcs	 49-2pcs
 50-1pcs	 51-1pcs	 52-2pcs				

Hardware List

 C 8*35 53PCS	 D 8*55 55PCS	 E 6*25 36PCS	 F 8*15 25PCS	 K 116PCS	 B M8*15 4PCS	 G M4*35 16PCS	 H 4*50-8PCS	 V 8*75 2PCS
---	---	---	---	--	---	--	---	--

Step 1

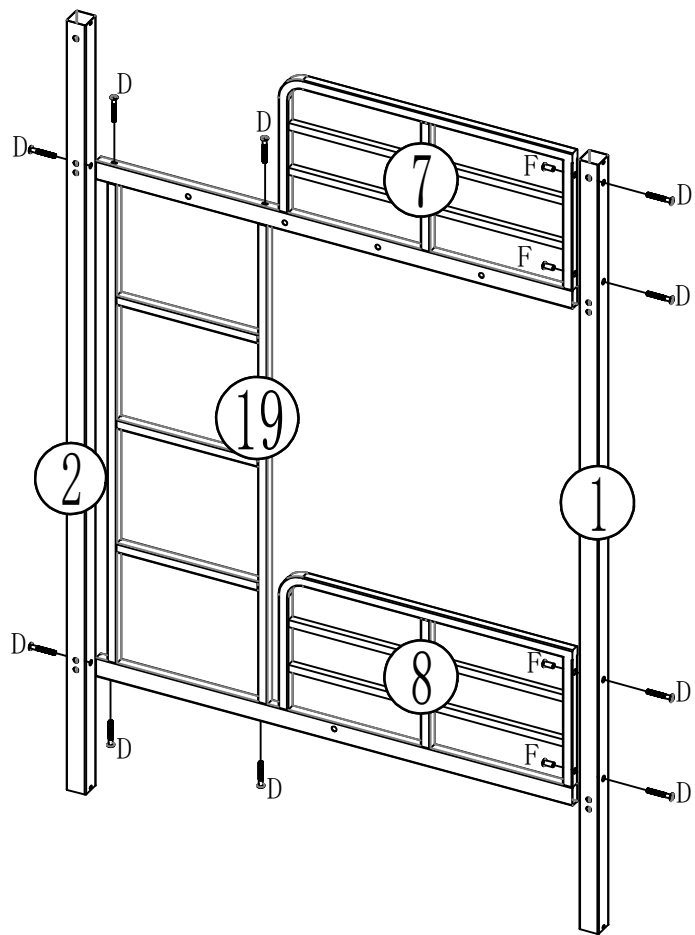

Step 2

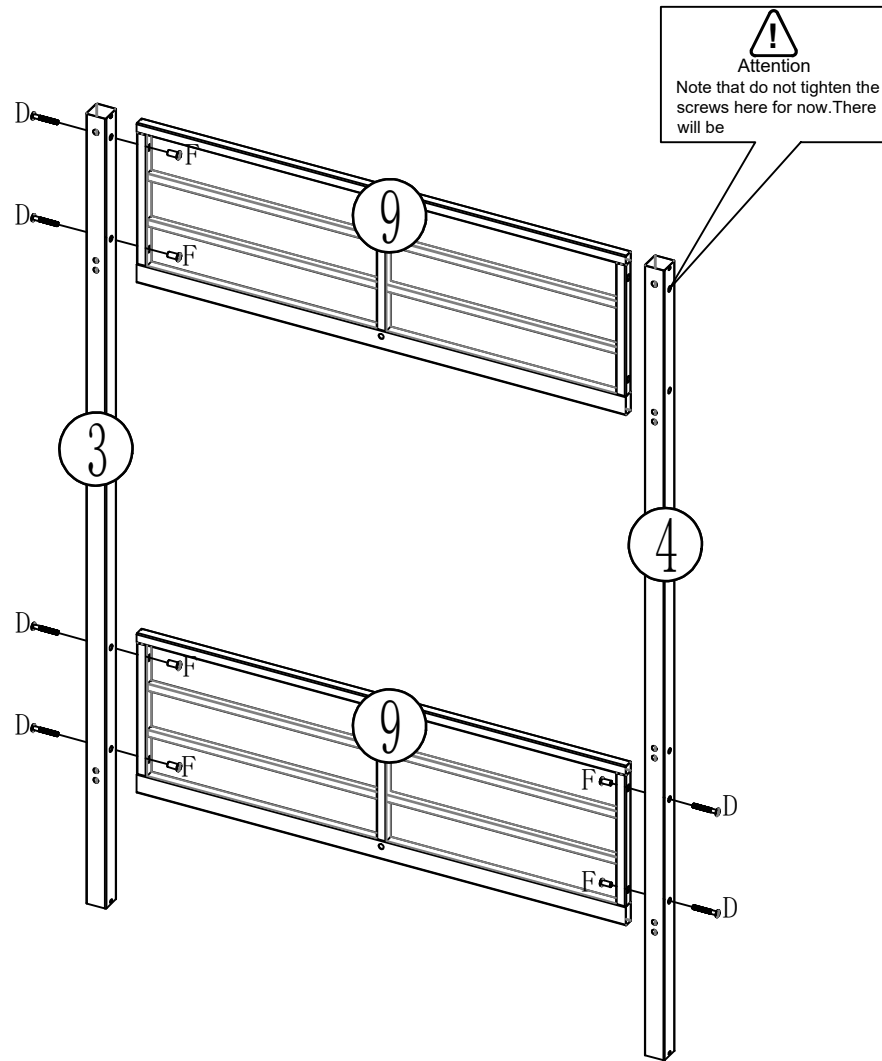

D
8*55-10PCS



F
4*15-4PCS



L



D
8*55-6PCS



F
4*15-6PCS



L

Step 3

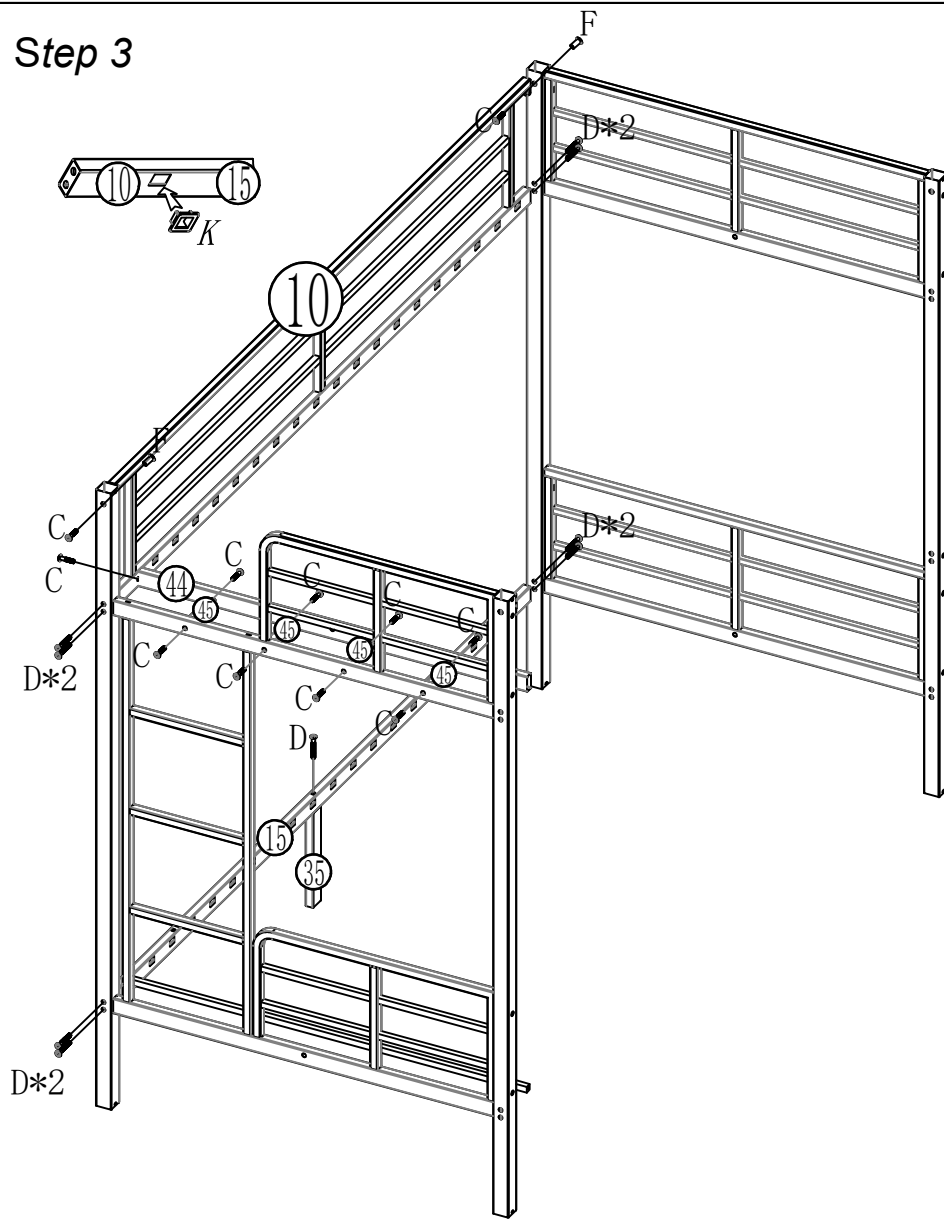

Step 4

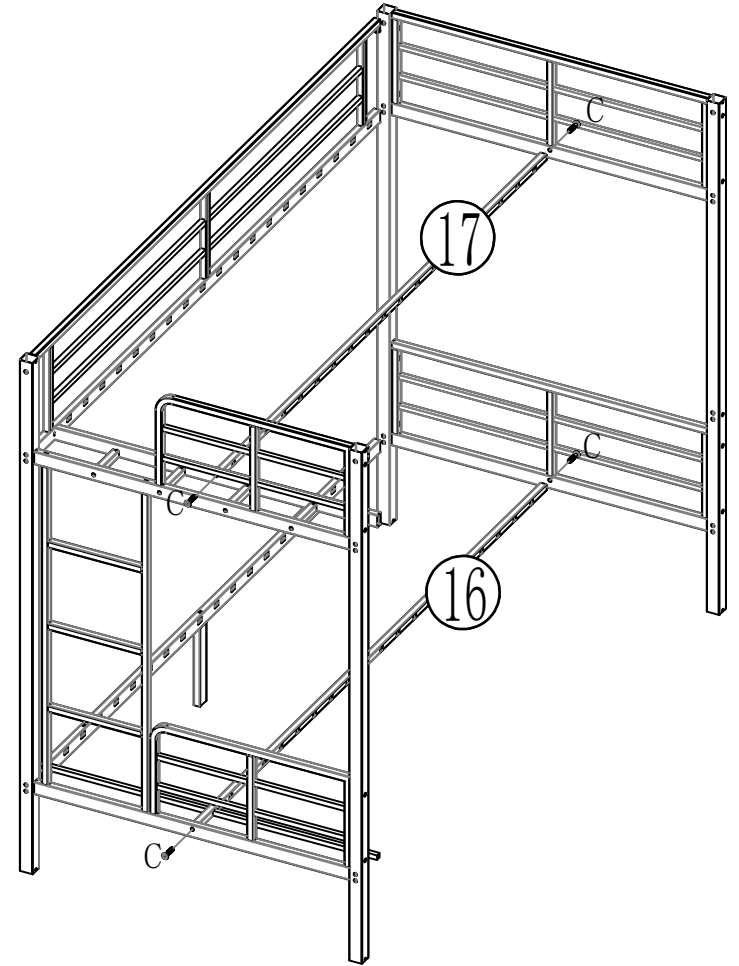

D
8*55-9PCS



C
M8*35
11PCS



K
39PCS



F
4*15-2PCS



L



C
M8*35
4PCS



L

Step 5

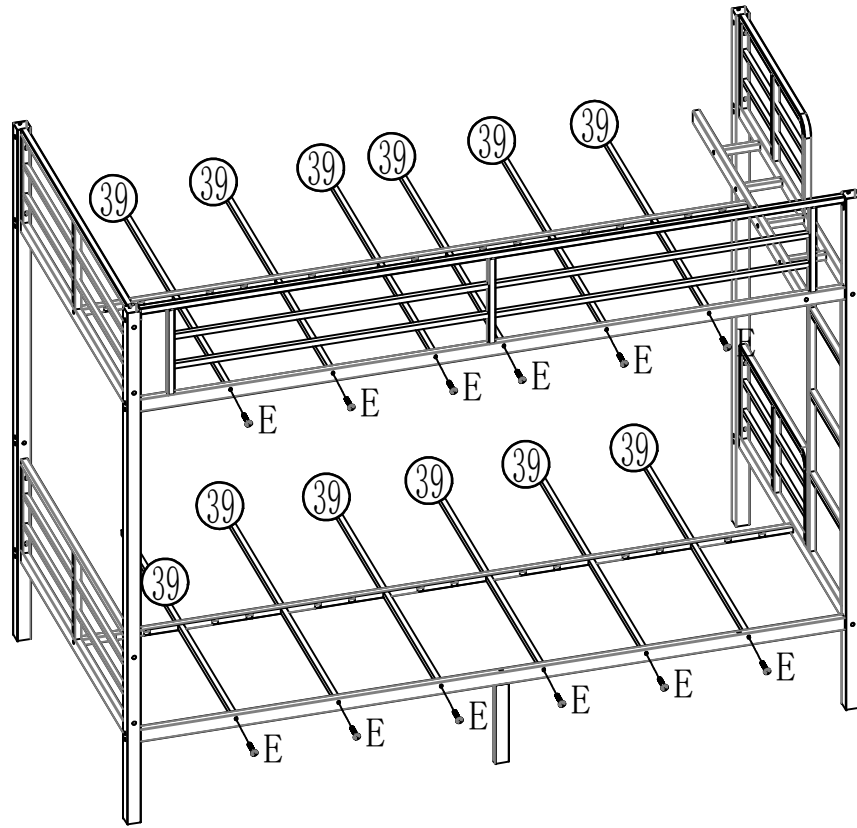

E

M6*25
12PCS



L

Step 6

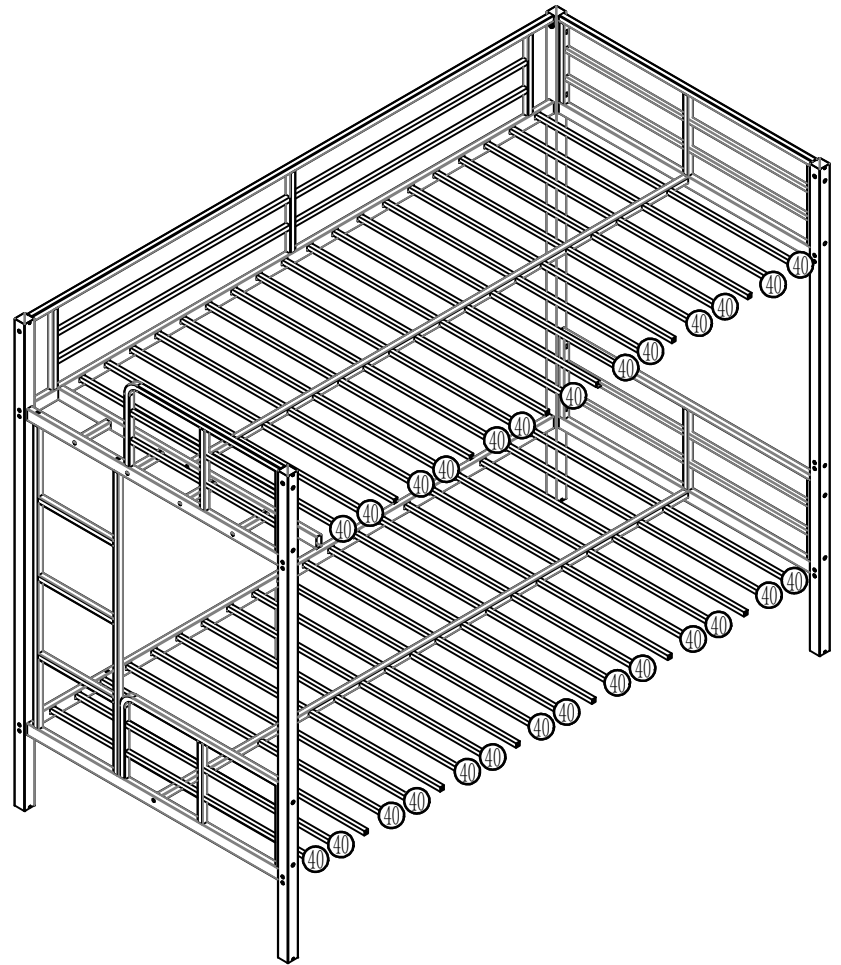

Step 7

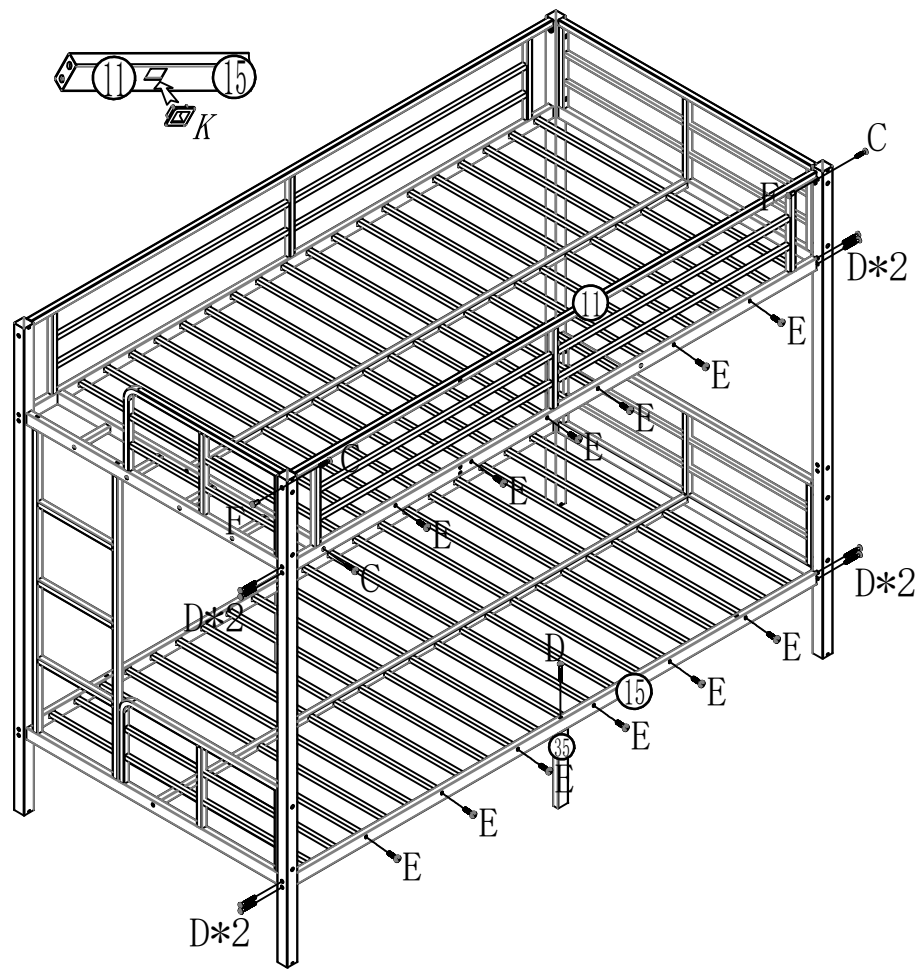

Step 8

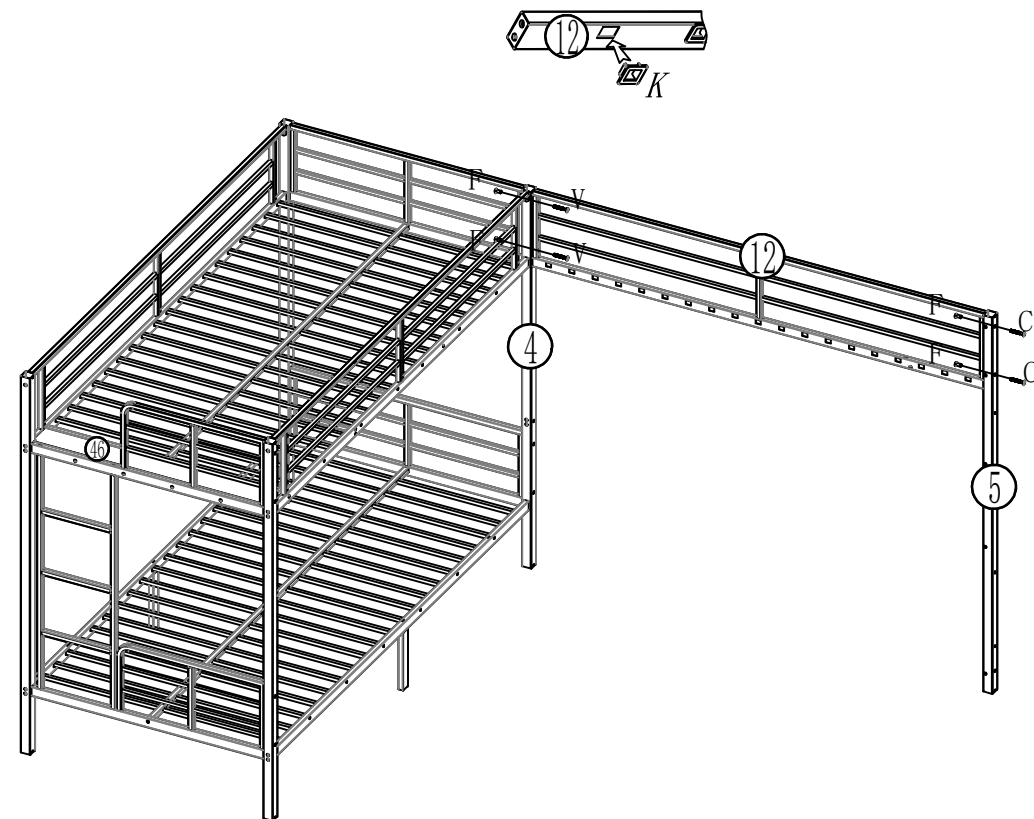

D
8*55-9PCS



F
2*15-2PCS



E
M6*25
12PCS



C
M8*35
3PCS



K
39PCS



L



C
M8*35
2PCS



F
4*15-4PCS



K
19PCS



V
M8*75-2PCS



L

Step 9

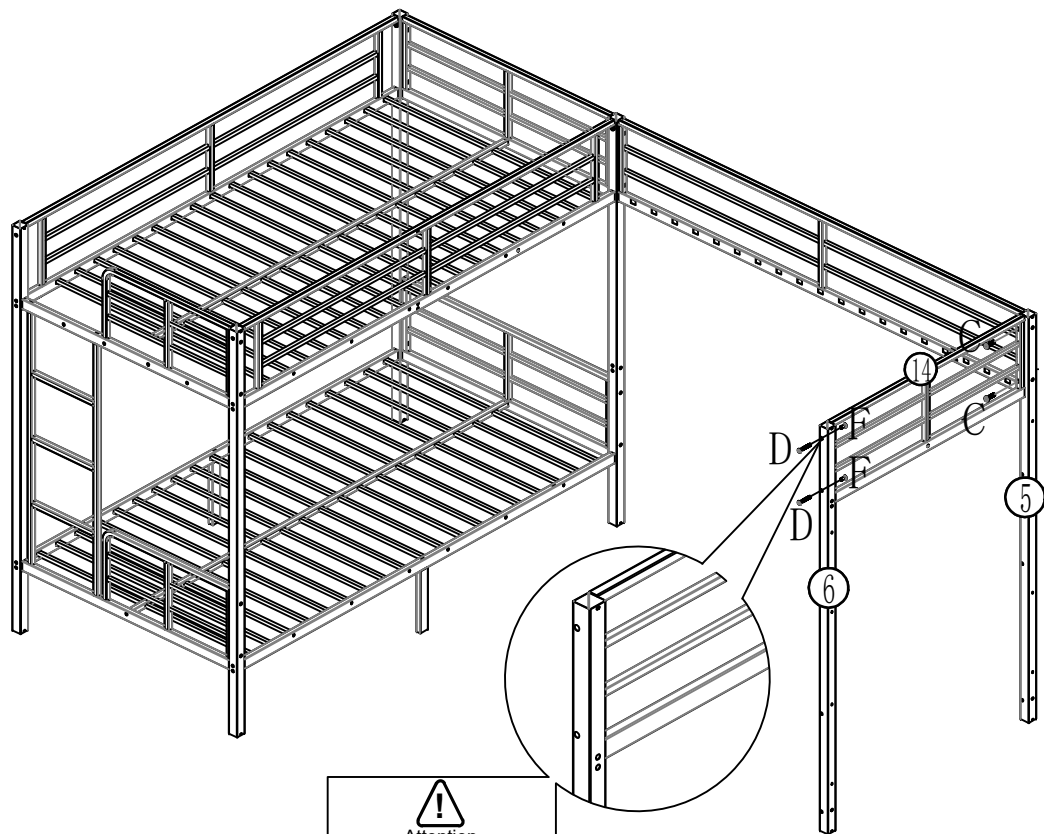

 Attention
 Note the installation
 direction of this hole.

Step 10

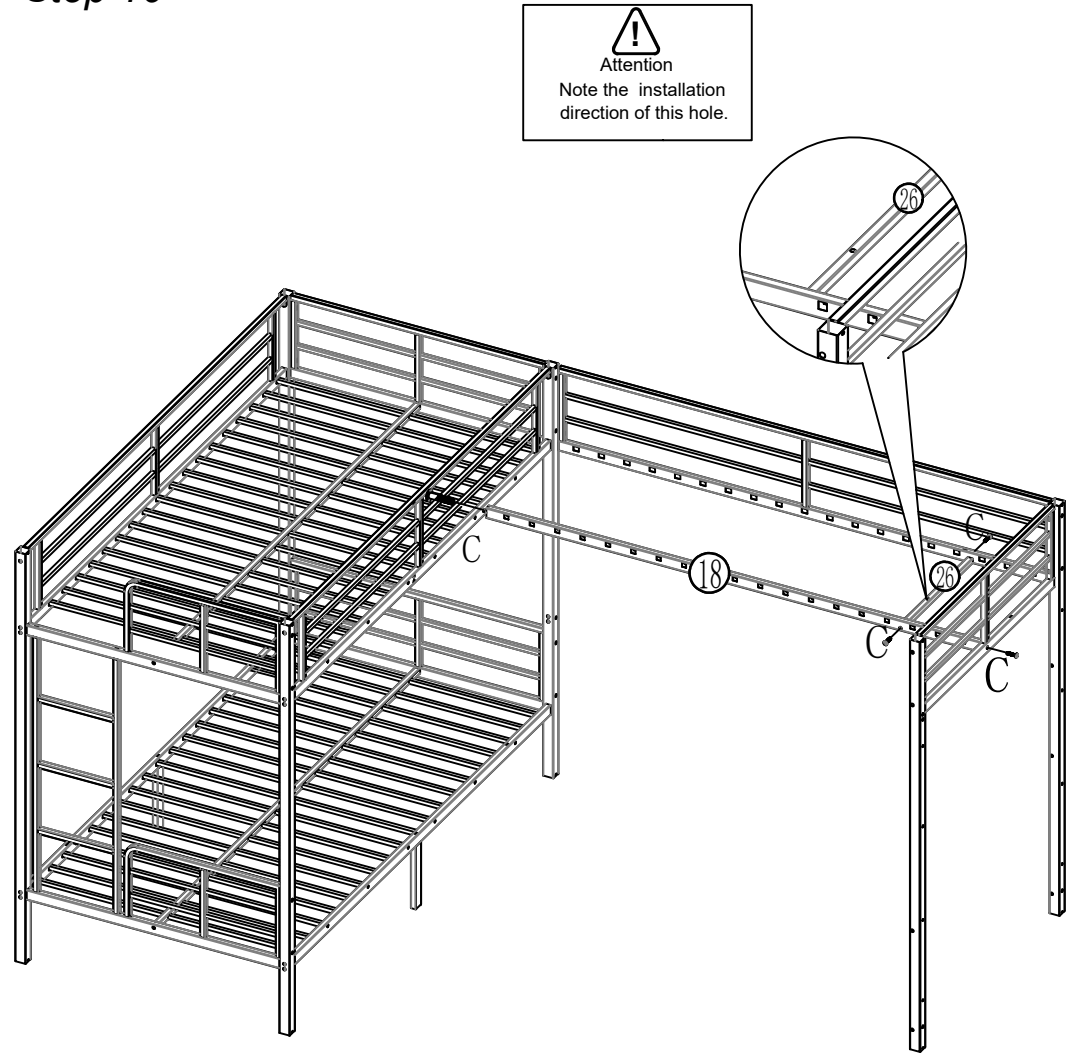

 Attention
 Note the installation
 direction of this hole.



D
8*55-2PCS



C
M8*35
2PCS



F
4*15-2PCS



L



C
M8*35
4PCS



L

Step 11

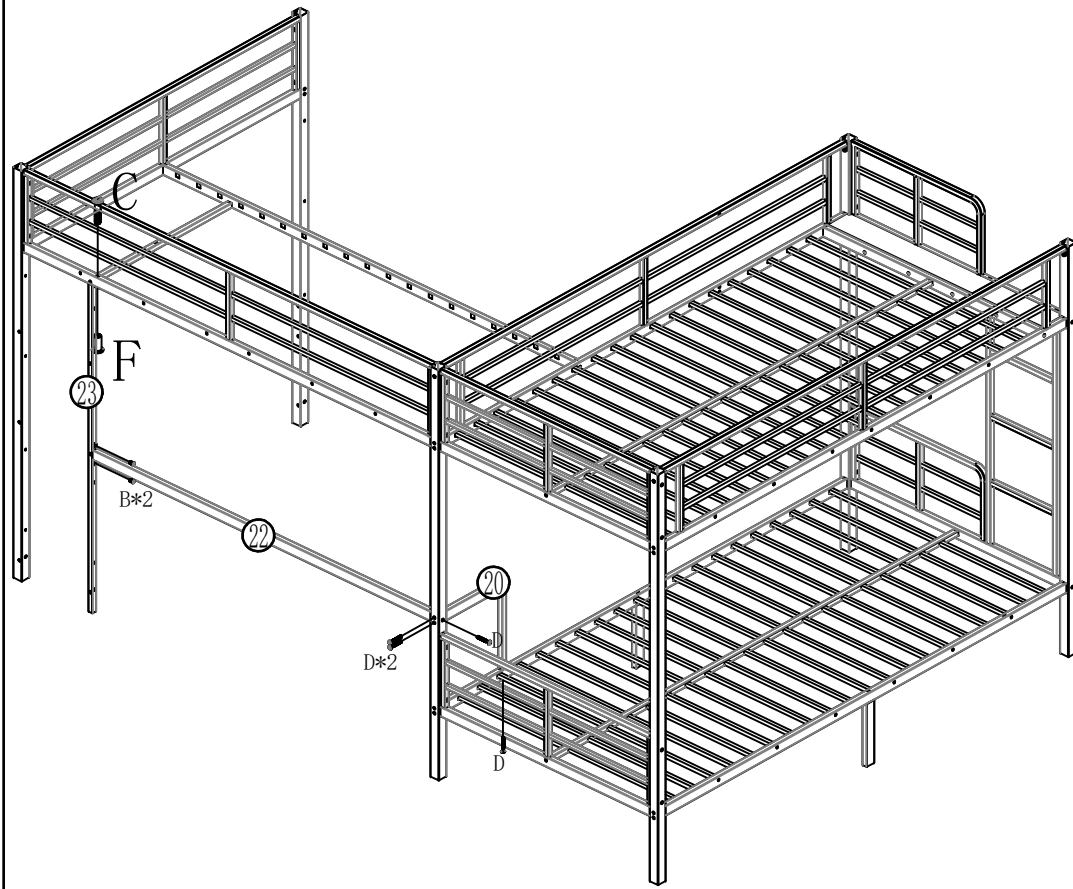

Step 12

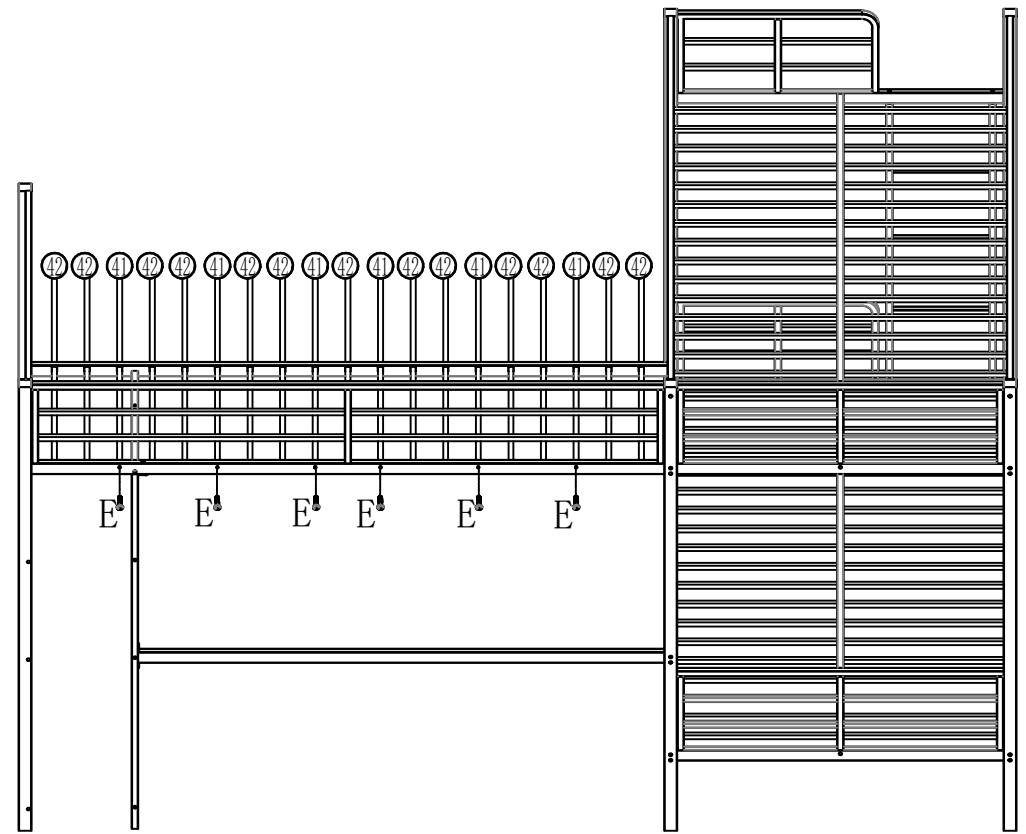

D
8*55-4PCS



F
4*15-1PCS



C
M8*35
1PCS



B
M8*15
2PCS

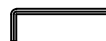

L



E
M6*25
6PCS



L

Step 13

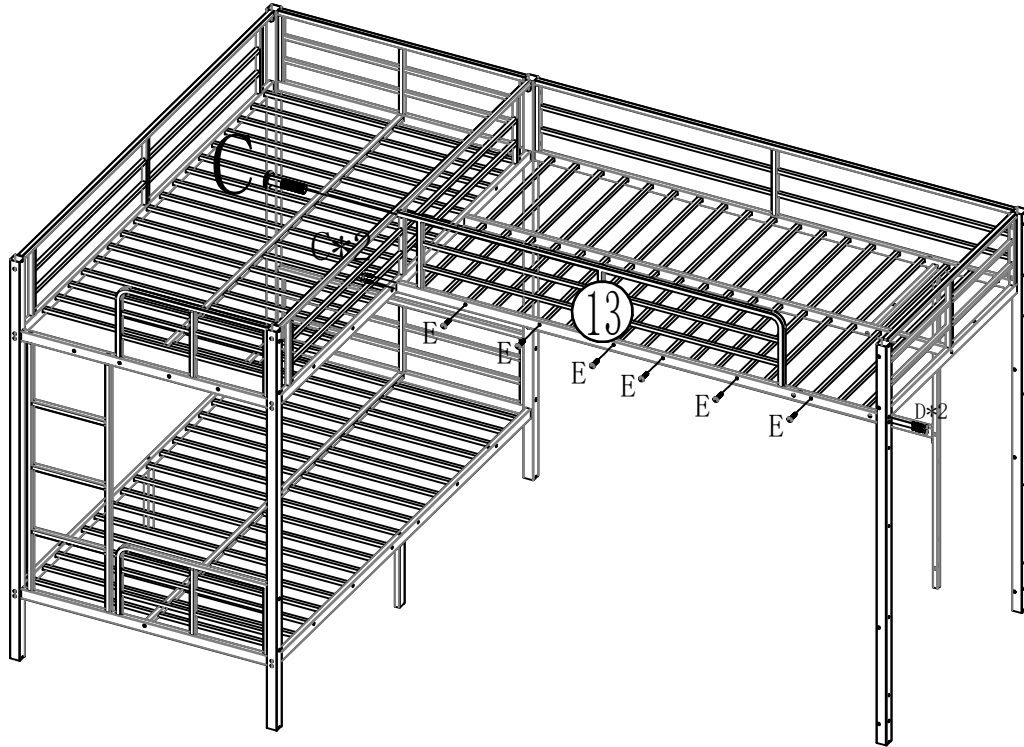
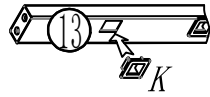

Step 14

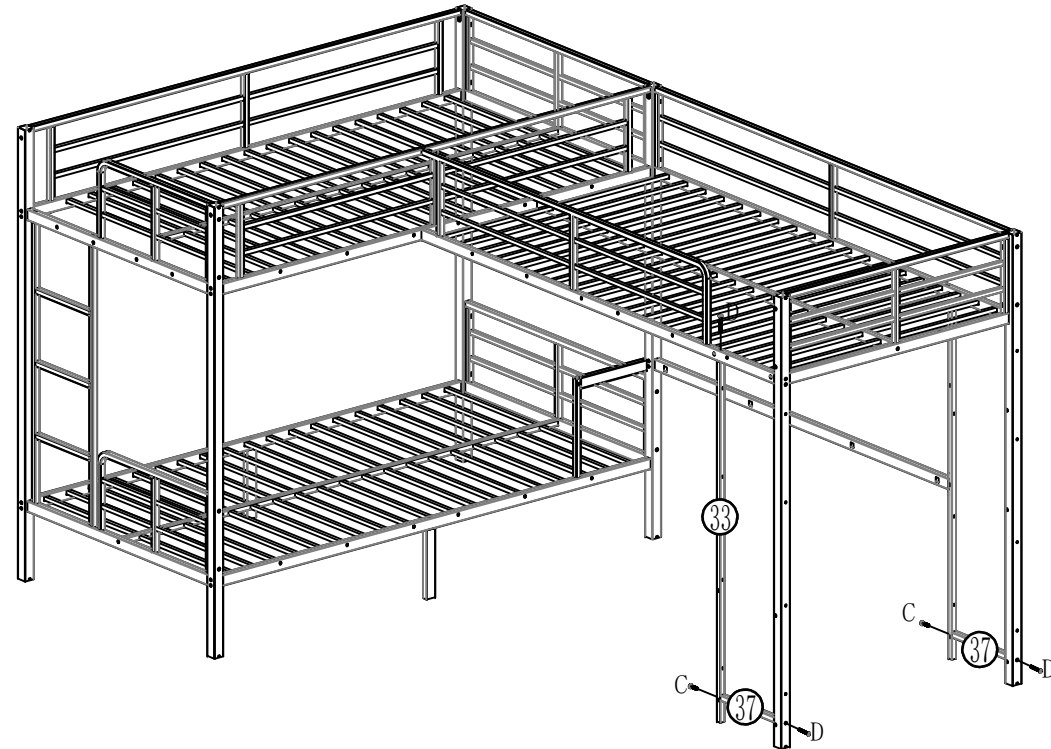

D
8*55-2PCS



C
M8*35
3PCS



K
19PCS



E
M6*25
6PCS



L



D
8*55-3PCS



C
M8*35
2PCS



L

Step 15

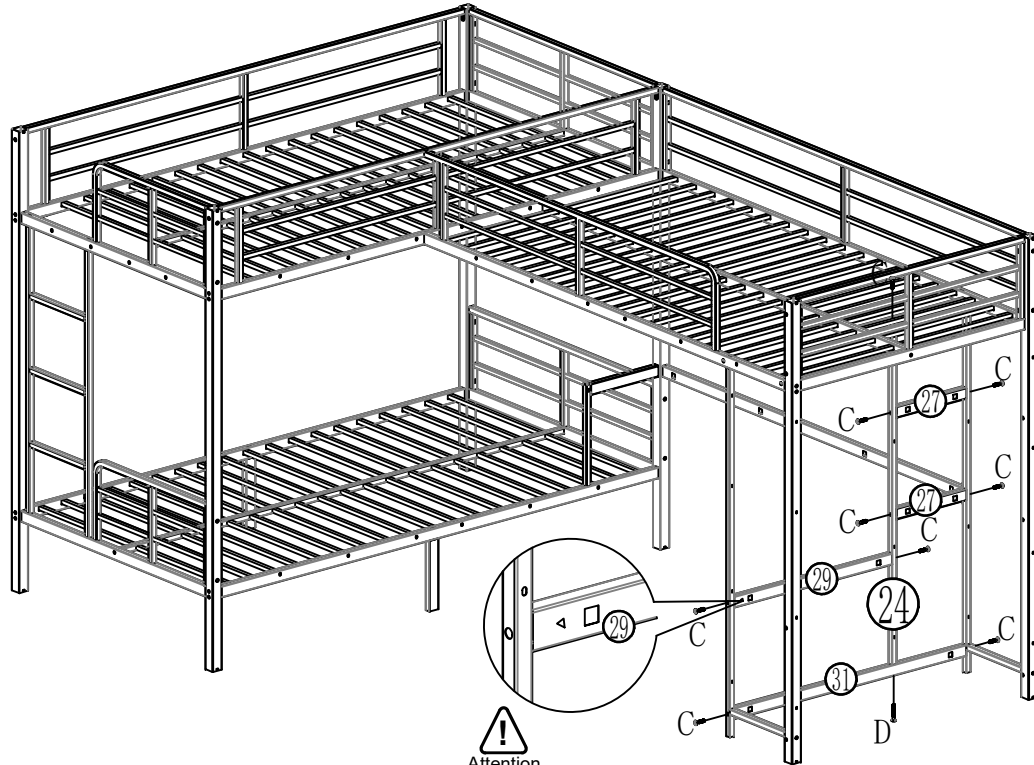

Attention

Note that the direction of arrow No. 25 is to the left.



C
M8*35
9PCS



D
8*55-1PCS



L

Step 16

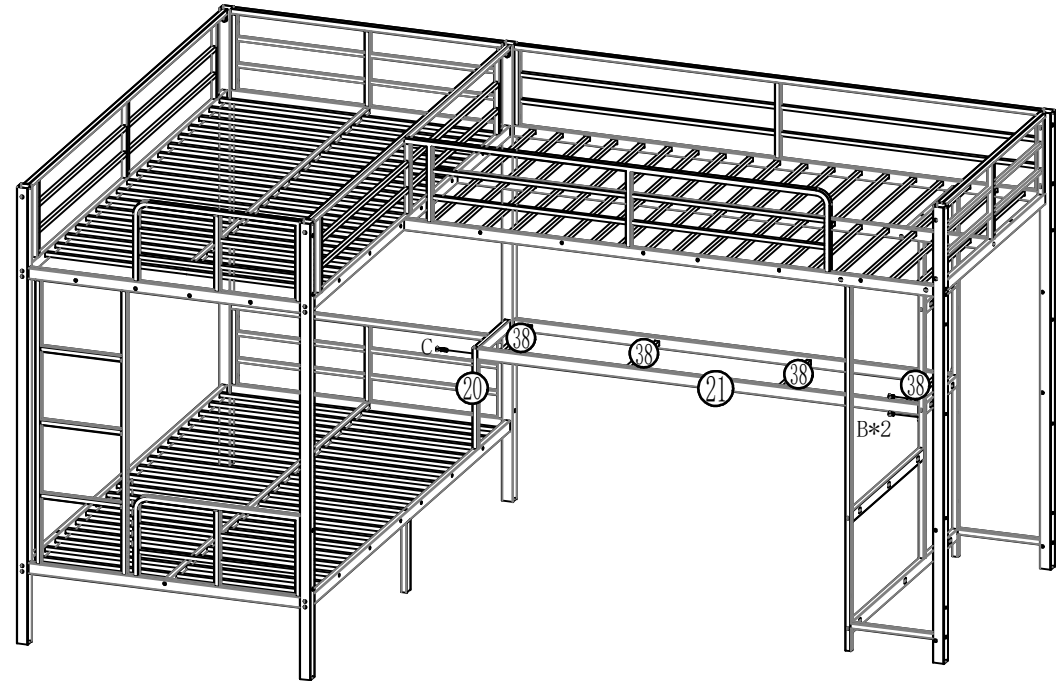

C
M8*35
1PCS



B
M8*15
2PCS



L

Step 17

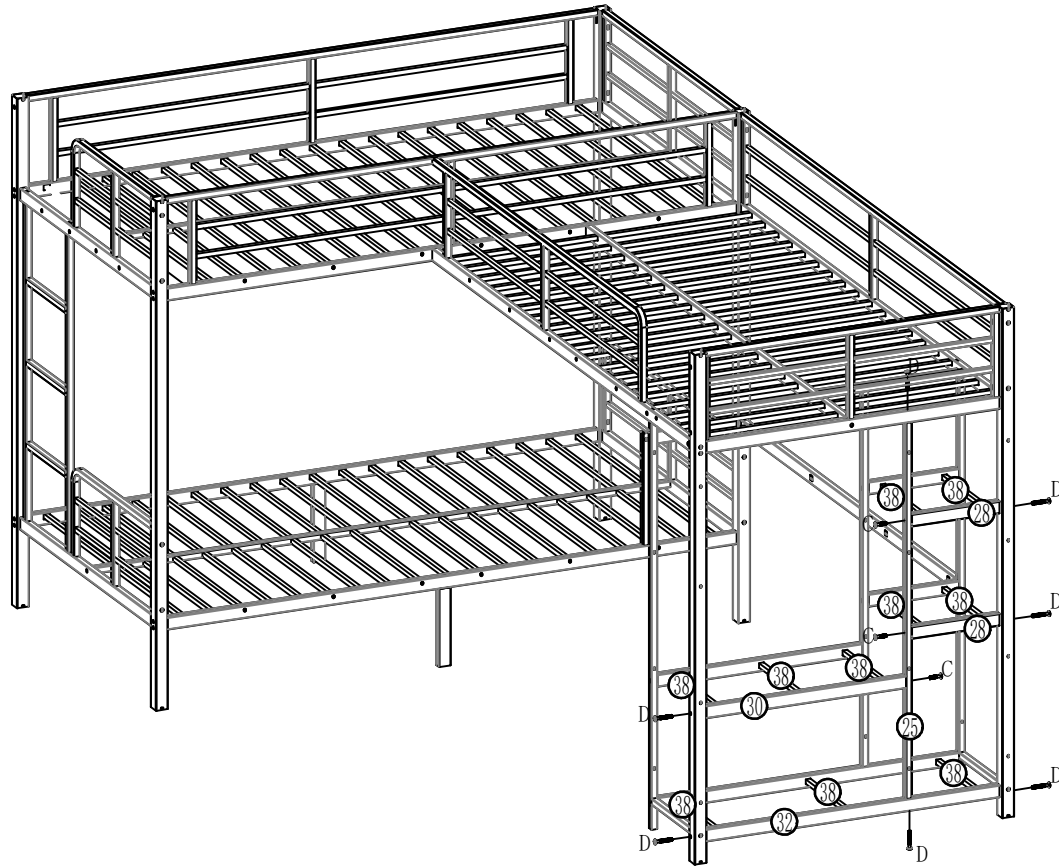

Step 18

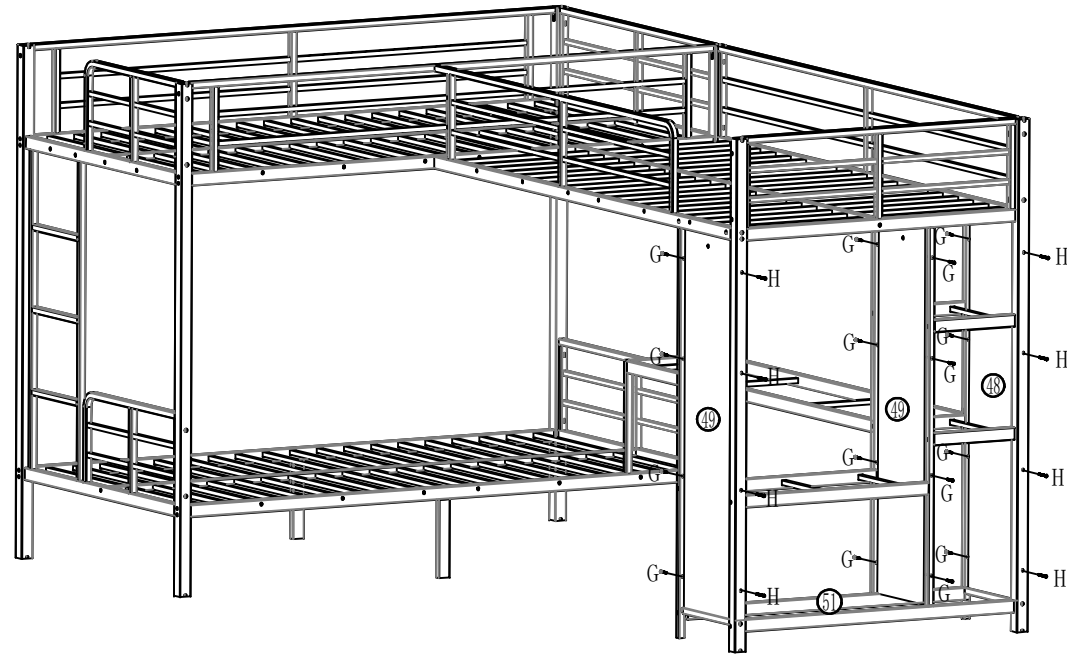

Here, Board 51 needs to be installed first .



D
8*55-7PCS



C
M8*35
3PCS



L



G
M4*35
16PCS



H
M4*55
8PCS



M
1PCS

Step 19

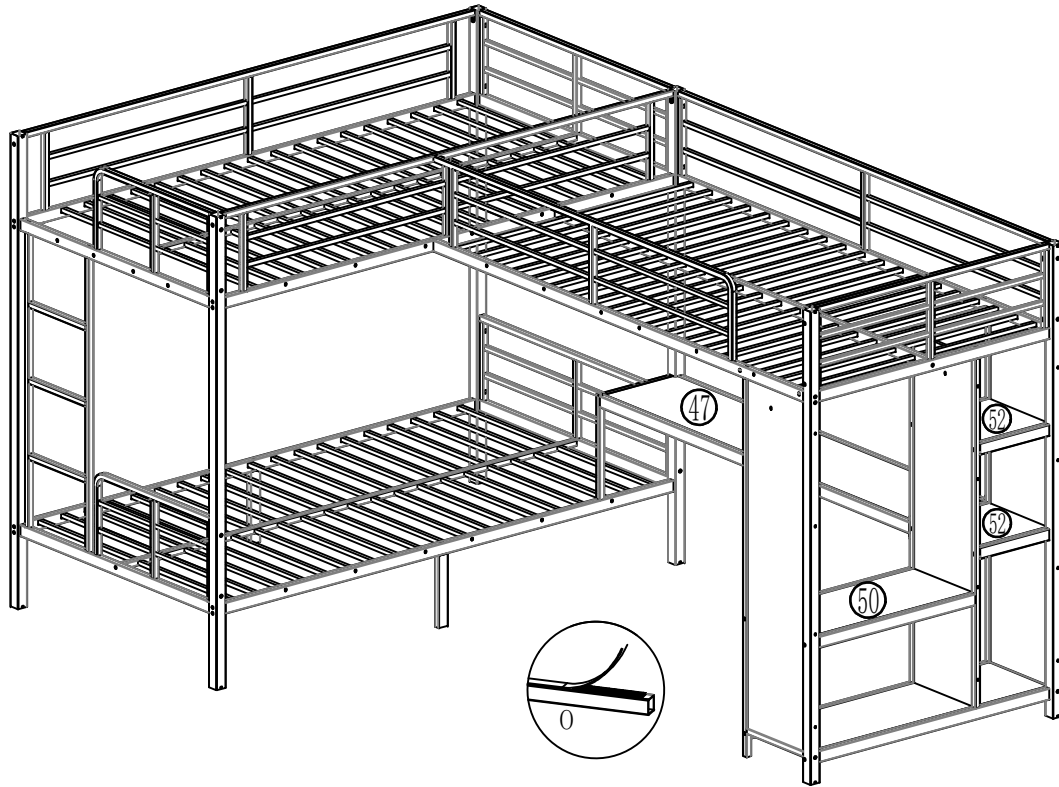

Use taep to stick #47,#52 and #50 onto their corresponding positions.



双面胶带
1PCS

Step 20

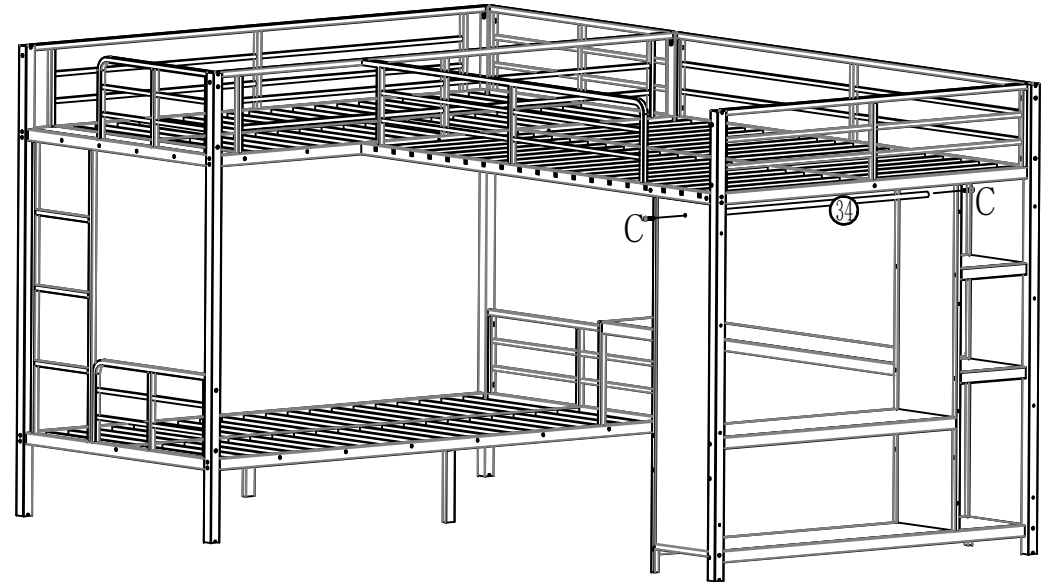

C
M8*35
2PCS



L

Step 21

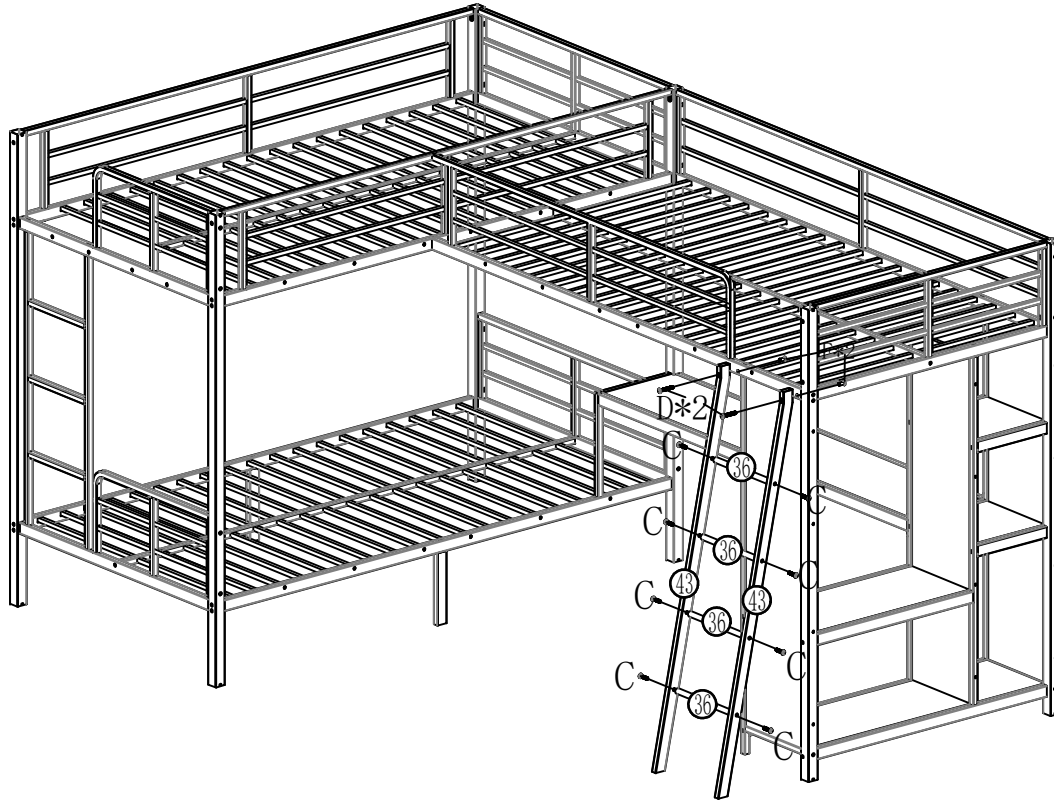

Completed bed

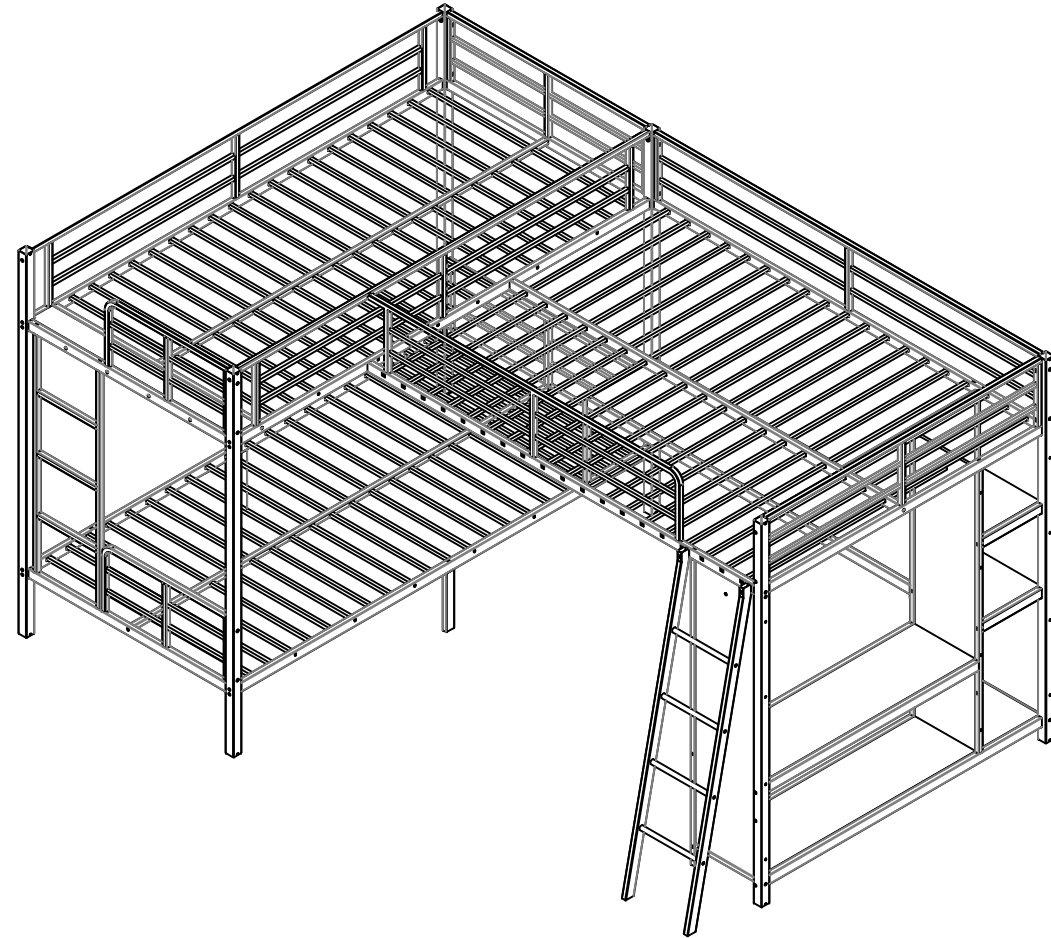

D
8*55-2PCS



C
M8*35
8PCS



F
4*15-2PCS



L



Attention

Please make sure all bolts are fastened before use, thank you.