

## CARE AND MAINTENANCE

Spot clean using a mild water-free solvent. Only a professional cleaner should undertake a complete overall cleaning.

The use of steam or water-based cleaners may cause excessive shrinking or staining.







## NOTICE

\* Please make sure that you have all parts indicated before you begin assembly of this item

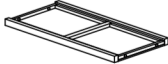
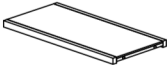
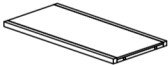
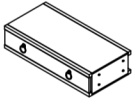
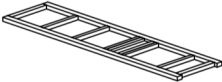
\* This item should be assembled on a soft surface to prevent scratching the finish during assembly

\* This item may require periodic tightening.

### PART LIST AND HARDWARE LIST

PIECE	DESCRIPTION	PICTURE	QUANTITY
A	TOP SHELF		1X
B	BOTTOM SHELF		1X
C	CENTER SHELF		3X
D	DRAWER		1X
E	SIDE PANELS (L&R)		2X
HW1	SHORT BOLT	6.3*1.3*35 mm 	28X
HW2	SPRING WASHER	8.5 mm 	28X
HW3	WASHER	8.5 mm 	28X
HW4	ALLEN KEY	4 mm 	1X
HW5	WOODEN PEGS	Φ10 x 30 mm 	14X
HW6	ANTI TIP KIT		1X

Product Dimensions: 32"W x 18"D x 70"H

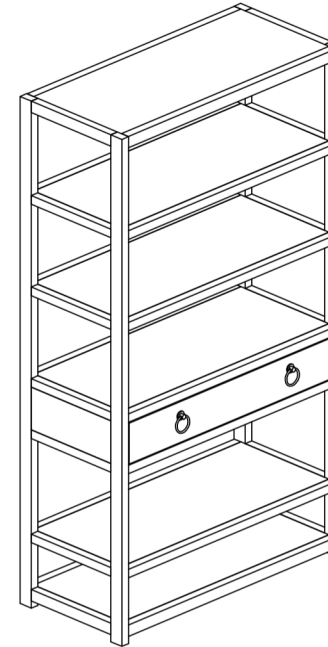

Weight capacity: 275lbs

WARNING: DO NOT STAND ON NIGHTSTAND

WARNING: DO NOT OVER TORQUE BOLTS

## PREPARATION

Before beginning assembly of product, make sure all parts are present. Compare parts with package contents list and hardware contents list.

If any part is missing or damaged, do not attempt to assemble the product.

Estimated Assembly Time: 15 minutes.

Tools Required for Assembly (included): Allen Key

