

(D) Montageanleitung

(NL) Handleiding voor de montage

(TR) Montaj talimatı

(F) Notice de montage

(CZ) Montážní návod

(HU) Szerelési útmutató

(GB) Assembly instructions

(PL) Instrukcja montażu

(RU) Инструкция по монтажу

(IT) Istruzioni di montaggio

(SK) Návod na montáž

(RO) Instrucțiuni de montaj

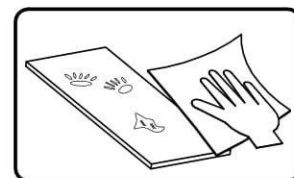
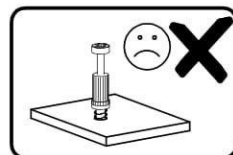
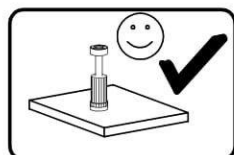
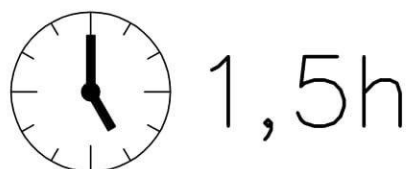
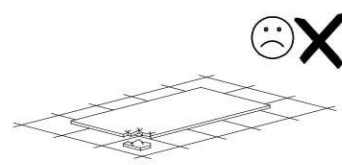
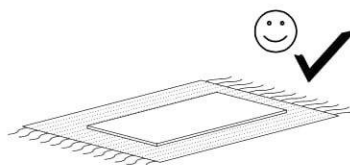
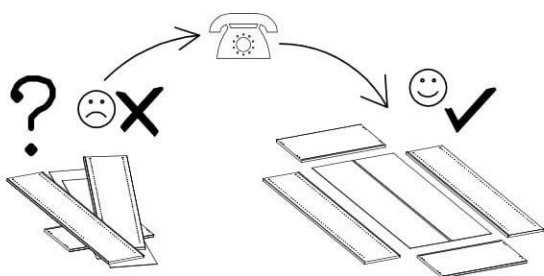
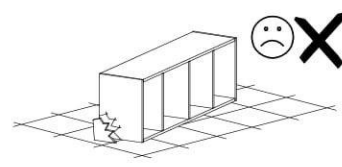
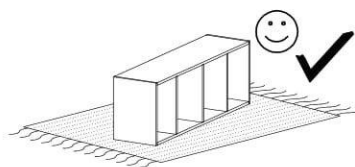
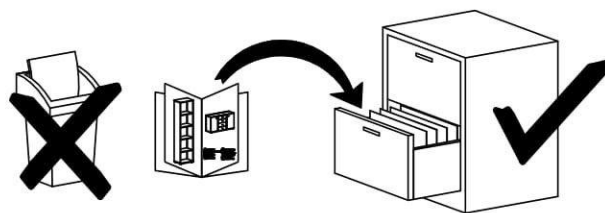
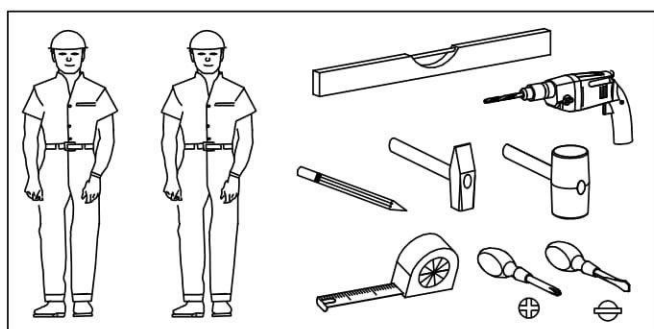

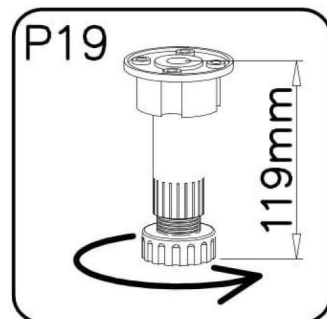
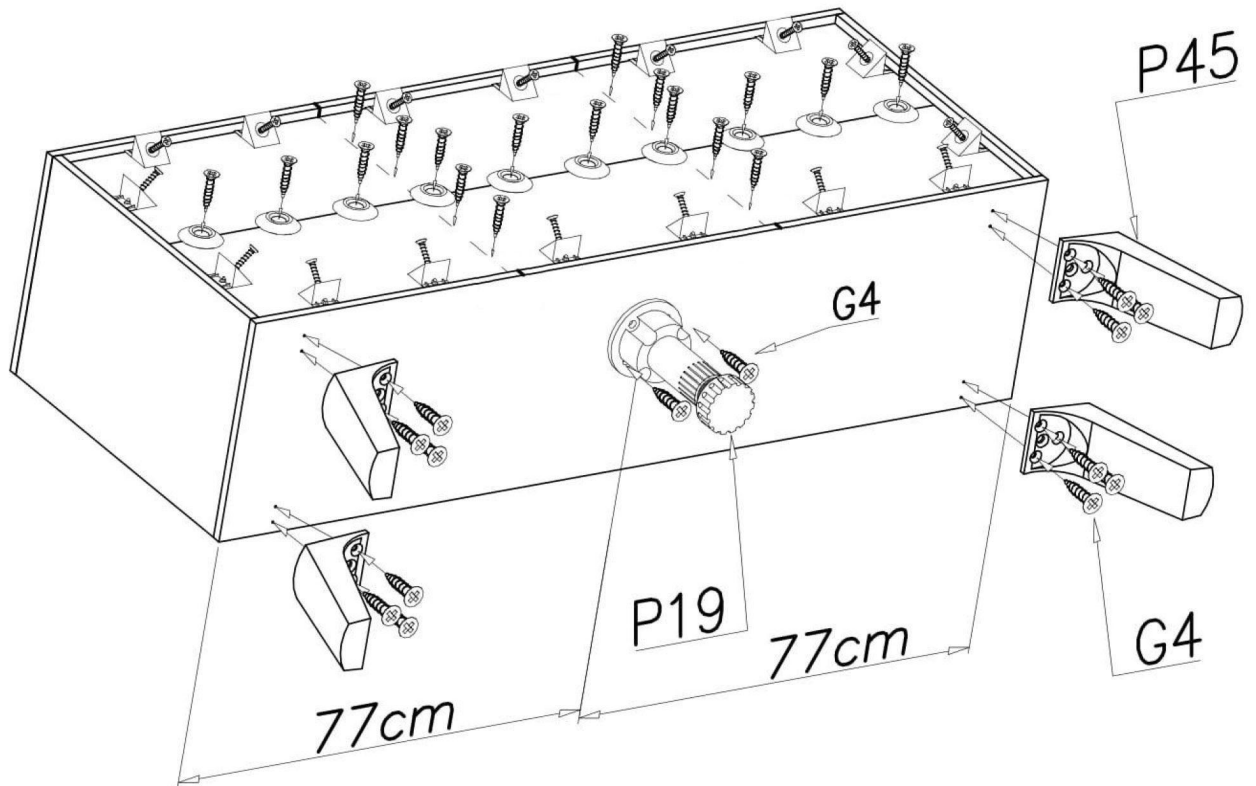
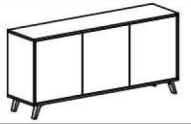

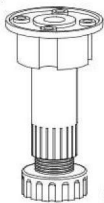
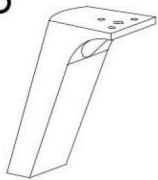
 P19 x...(1) 120mm	 P45 x...(4)
---	---

 G4 4x16 x...(32)
--