











Assembly Instructions

Caution : You must read this before you proceed

Care & Maintenance

- ⊘  ● Not for commercial use. For residential use only.
- ⊘  ● Prolonged exposure to rain may cause rusting which can stain floors.
- ⊘  ● Do not put hot items directly on furniture surface.
- ⊘  ● Do not clean furniture with harsh cleansers or polish.
- ✓  ● To obtain the longest lifespan of your outdoor products, minimizing exposure to direct sunlight is recommended.
- ⊘  ● Children should not climb or jump on the furniture.
- ⊘  ● Do not write on furniture without a padded barrier to protect the surface.
- ✓  ● To obtain the longest lifespan of your outdoor products, avoid extended and lengthy exposure to rain, snow, and direct sunshine. Whenever possible cover the product and /or place under patio or awnings.
- ⊘  ● Stains may be removed with mild soap solution and damp cloth.
- ✓  ● Keep away from sources of ignition.
- ✓  ● Dust and pick-up spills using a clean, non-colored, lint-free cloth.



Please look in Boxes for hardware packs and legs.

Sets often ship in multiple boxes and may arrive a day or two apart.

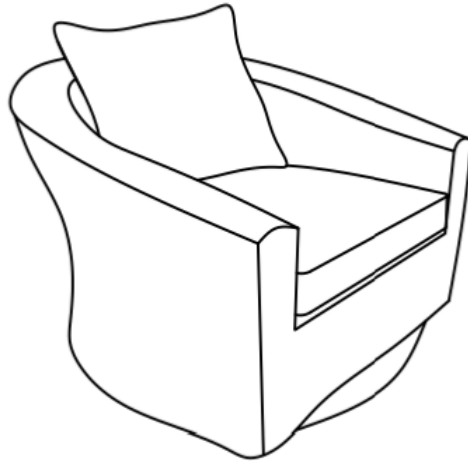
Swivel Chair

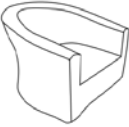

Parts List

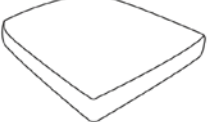
Label	Picture	Description	QTY
A		Seat	1
B		Swivel Plate	1
C		Back Cushion	1
D		Seat Cushion	1

Hardware

Label	Picture	Description	QTY
①		Bolt (M6*40mm)	5
②		Nut	5
③		Allen Wrench	1
④		Wrench	1

Assembly Preparation

Before Beginning Assembly:

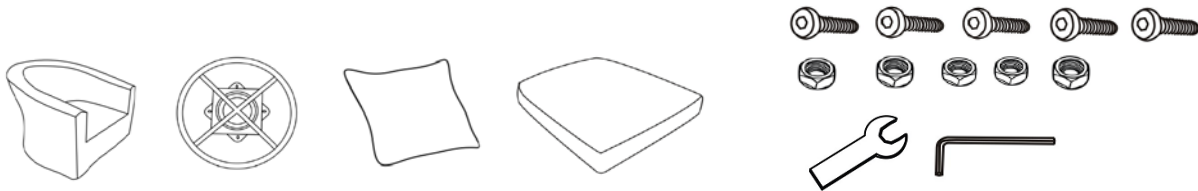

- Read instructions, cover to cover-



- Have 2 adults on hand for assembly-



- Do not assemble on flooring or carpet-



- Assemble on a clean non-marring surface (packing foam)-



- Save all packaging until finished-

Assembly Steps

Overview

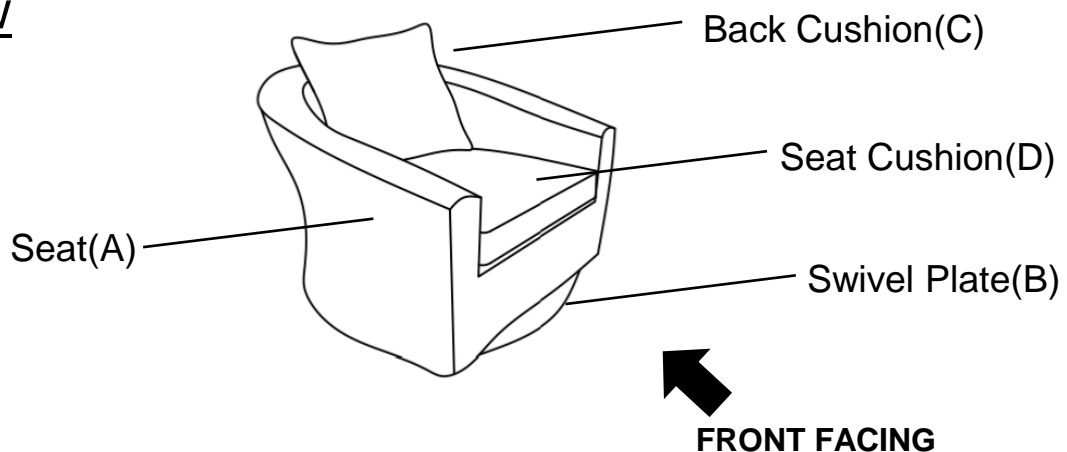

This Swivel Chair has multiple parts and may require up to 10 minutes to assemble. To give you an overview of the Swivel Chair parts, the above picture is to help you put the various parts into perspective. Please read through the instructions below to familiarise yourself with the parts and steps before assembly.

Step 1

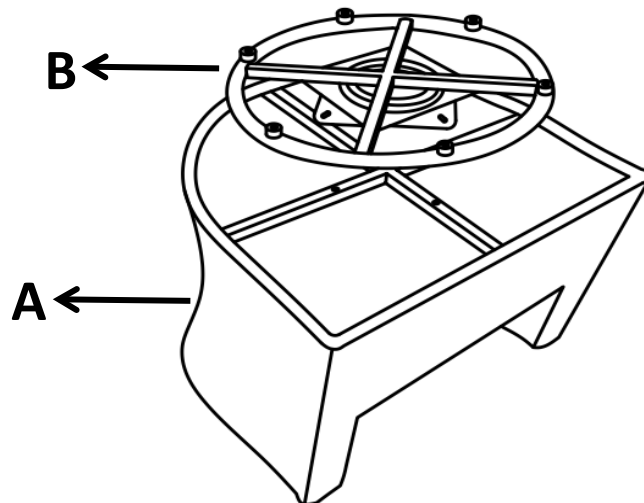

Open the carton and place all the parts onto a clean and soft surface.

Turn the Seat(A) upside down.

Put the Swivel Plate (B) into Seat(A) and align the mounting positions of the Seat(A) as show picture.

Step 2

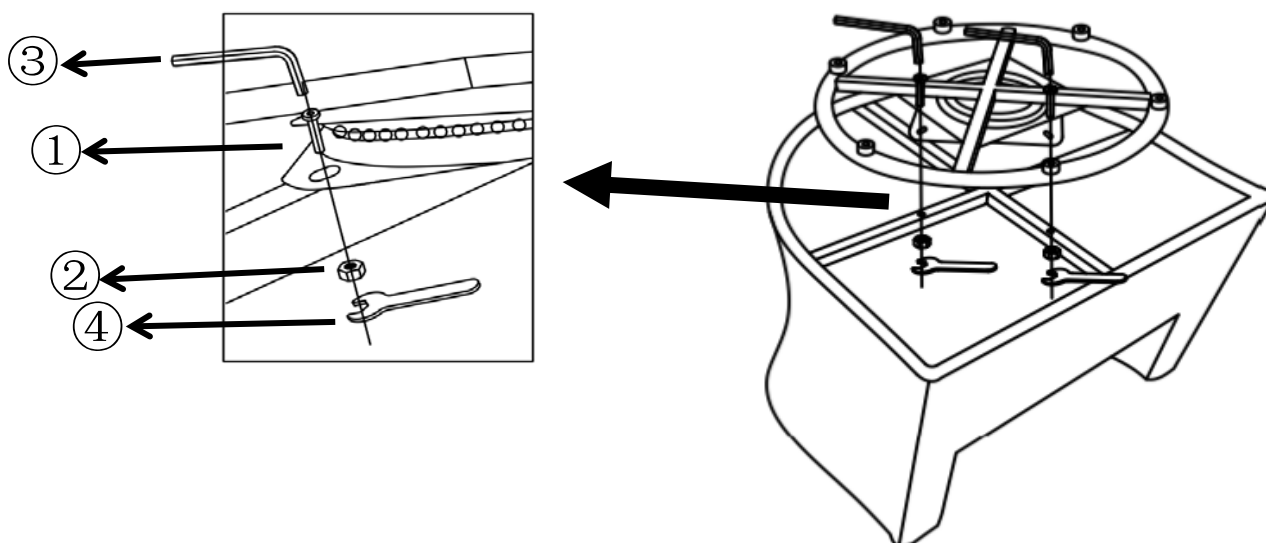

Attach Swivel Plate(B) to Seat(A) using Bolts(①) and Nuts(②) with Allen Wrench(③) and Wrench(④).

Tighten Nuts and Bolts fully in a sequential manner.

Step 3

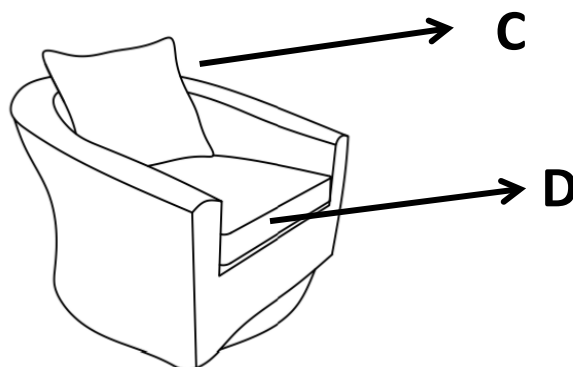

Put the Back Cushion(C) and Seat Cushion(D) on the Chair.

Your Chair is ready for use.

This Chair can only be used on a flat, level surface.