

ASSEMBLY INSTRUCTIONS



Bar Table

ASSEMBLY INSTRUCTIONS

ASSEMBLY TIPS:

- 1.Remove hardware from box and sort by size.
- 2.Please check to see that all hardware and parts are present prior to start of assembly.
- 3.Please follow attached instructions in the same sequence as numbered to assure fast & easy assembly.



Warning !!





1. Don't attempt to repair or modify parts that are broken or defective. Please contact the store immediately.
2. This product is for home use only and not intended for commercial establishment.

ASSEMBLY TIME

15 MINUTES

PARTS IDENTIFICATION

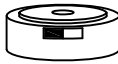

B1 (BOX 1)

	PART NAME	FIGURE	QTY
A	Metal Base		1PC
B	Metal Top Cover		1PC
C	Led Box		1PC
D	Glass Top		1PC

B2 (BOX 2)

E	Metal Post		1PC
---	------------	--	-----

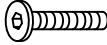
HARDWARE IDENTIFICATION

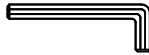
	HARDWARE NAME	FIGURE	QTY
1	Bolt 5/16" X 32mm		1PC
2	Washer		1PC
3	Bottom Cover		1PC
4	Allen Wrench		1PC

NOTE : QUANTITIES SHOWN ARE FOR ONE TABLE

ASSEMBLY INSTRUCTIONS

STEP 1

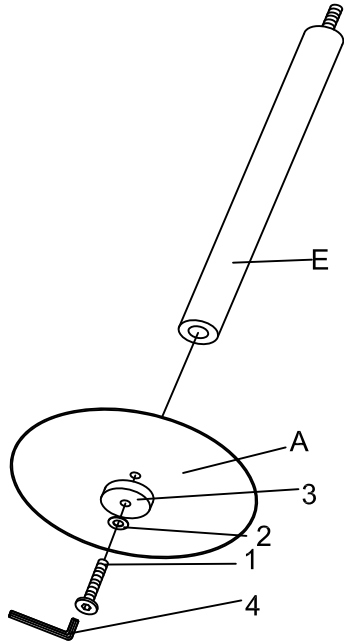

STEP 2

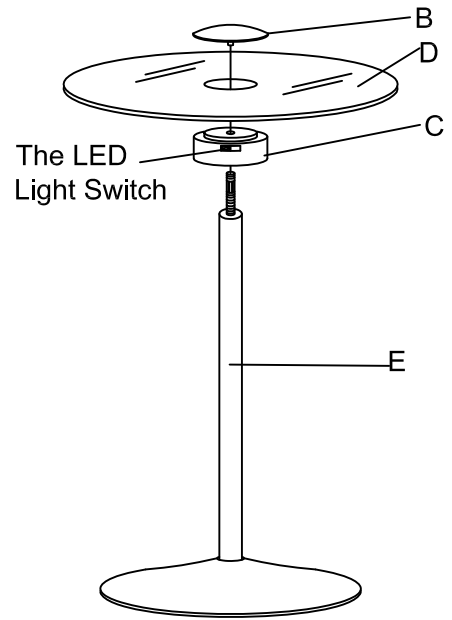

STEP 3

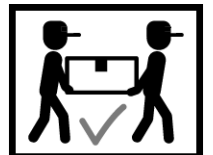
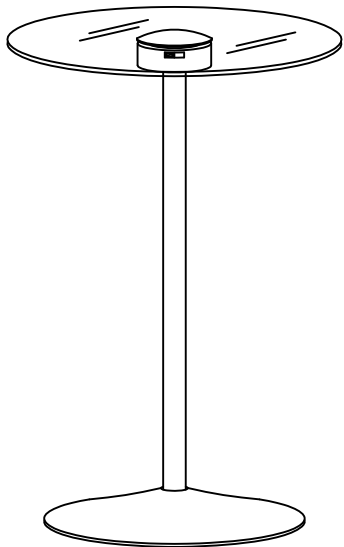

(B1-B2)

