

Assembly Instruction

SECTIONAL SOFA

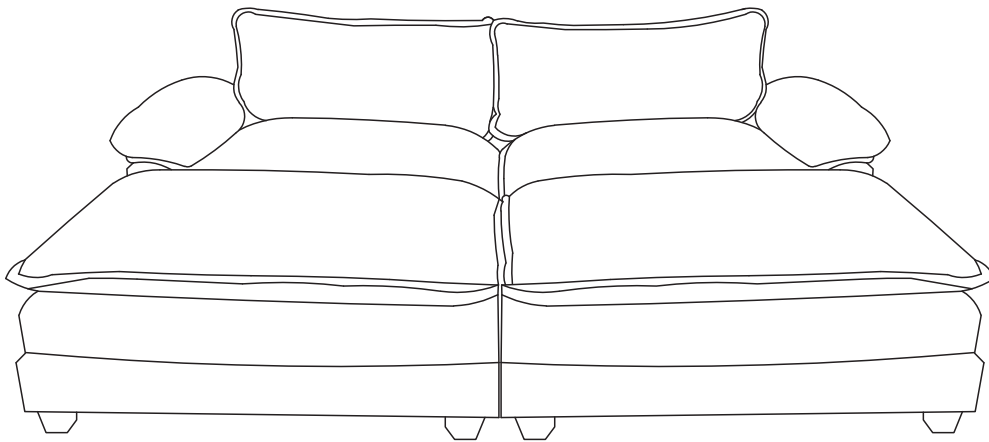

Thank you for choosing our product.

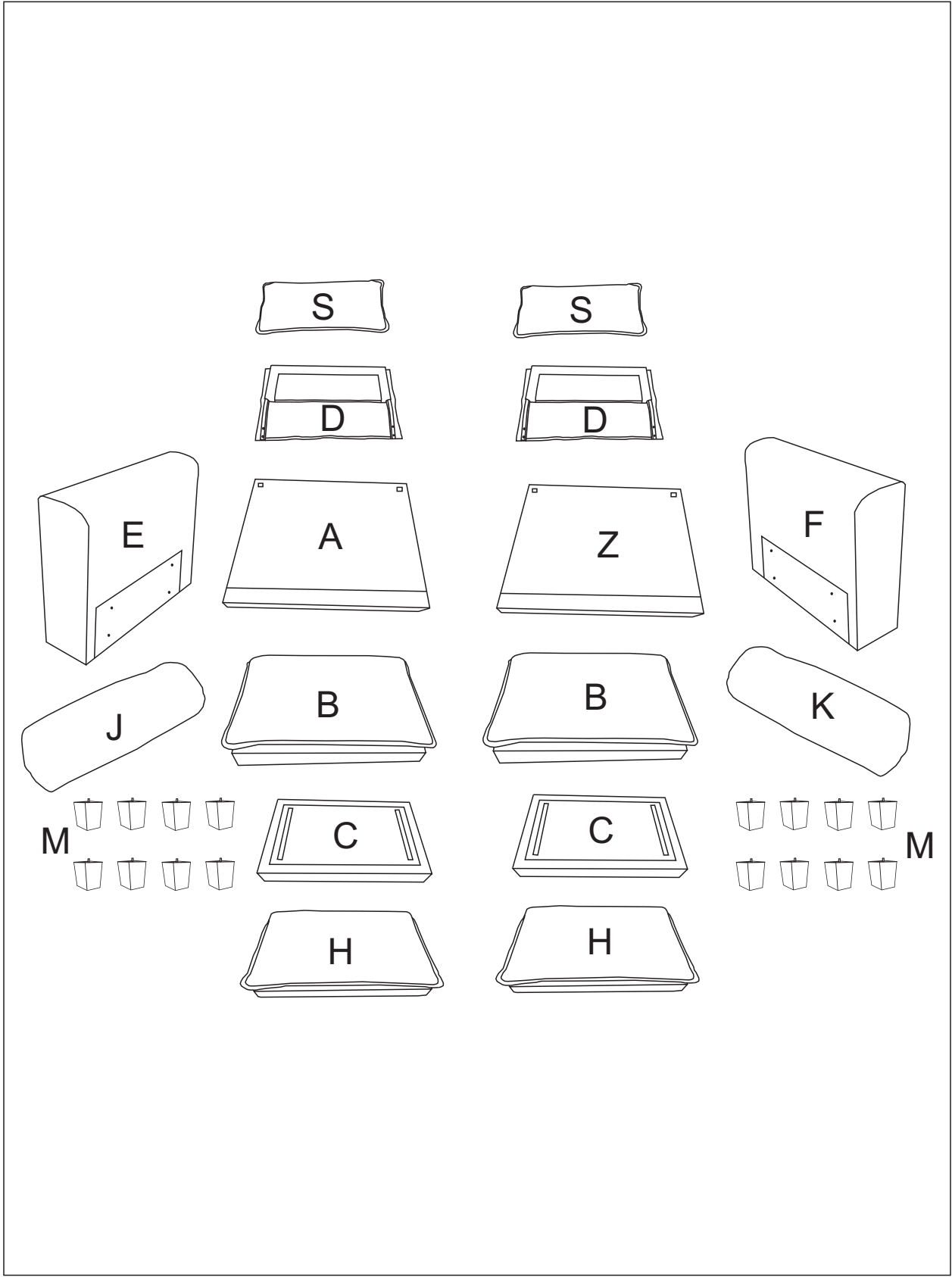

To ensure safe and satisfactory use of this product, please carefully read the below instructions beforehand.

1. This sofa ships in 3 boxes, we recommend unpacking and starting assembly when 3 boxes are received.
2. Our cushions are vacuum packed for convenient shipping. Please allow 2-3 days for them to fully expand to their original shape and for any wrinkles to disappear.
3. In the event that a part is damaged or missing, no need to return the product, we will gladly help and ship your replacement parts free of charge.





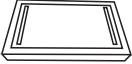





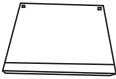

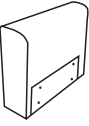

PART LIST & HARDWARE





Parts List BOX 1

<p>C Ottoman frame</p>  <p>2PCS</p>	<p>H Ottoman cushion</p>  <p>2PCS</p>	<p>M Leg</p>  <p>8PCS</p>
---	---	---

Parts List BOX 2

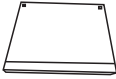
<p>A Left seat frame</p>  <p>1PC</p>	<p>B Seat cushion</p>  <p>1PC</p>	<p>S Back cushion</p>  <p>1PC</p>	<p>D Backrest</p>  <p>1PC</p>
<p>M Leg</p>  <p>8PCS</p>	<p>E Left armrest</p>  <p>1PC</p>	<p>F Right armrest</p>  <p>1PC</p>	<p>L Gasket</p>  <p>16PCS</p>
<p>N Washer</p>  <p>24PCS</p>	<p>O M8*60mm Bolt</p>  <p>16PCS</p>	<p>I M8*80mm Bolt</p>  <p>4PCS</p>	<p>T Butterfly Nut</p>  <p>4PCS</p>
<p>R Alley Key</p>  <p>1PC</p>			

Parts List BOX 3

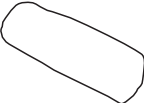
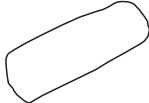
<p>Z Right seat frame</p>  <p>1PC</p>	<p>B Seat cushion</p>  <p>1PC</p>	<p>S Back cushion</p>  <p>1PC</p>	<p>D Backrest</p>  <p>1PC</p>
<p>K Right armrest cushion</p>  <p>1PC</p>	<p>J Left armrest cushion</p>  <p>1PC</p>		

Note: Please retain all boxes until you are certain that your product isn't damaged and that you do not wish to return it. Disposal of boxes may prevent our ability to resolve your request.

ASSEMBLY STEPS

STEP 1: Connect Left armrest (E) & Seat frame (A) with Bolts (O) and Washers (N).

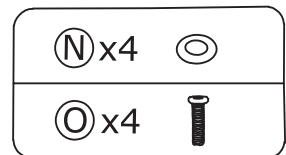
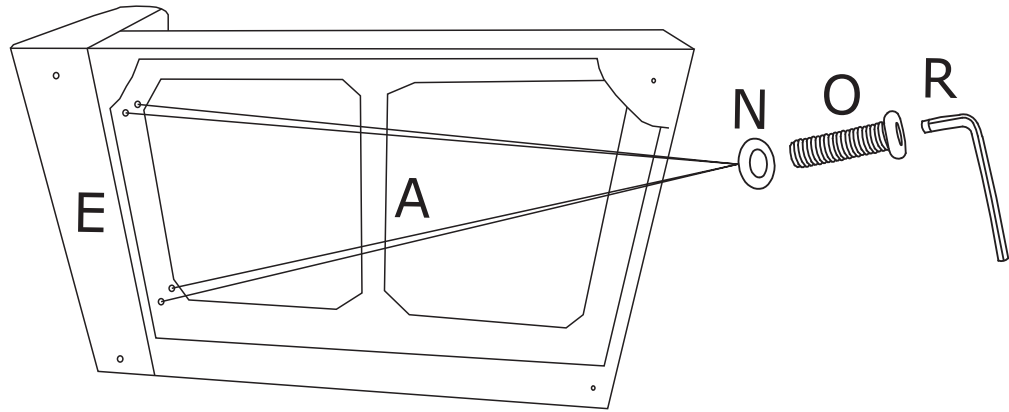

STEP 2: Connect Right armrest (F) & Seat frame (Z) with Bolts (O) and Washers (N).

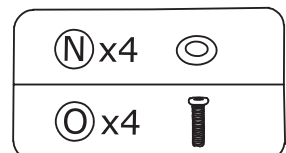
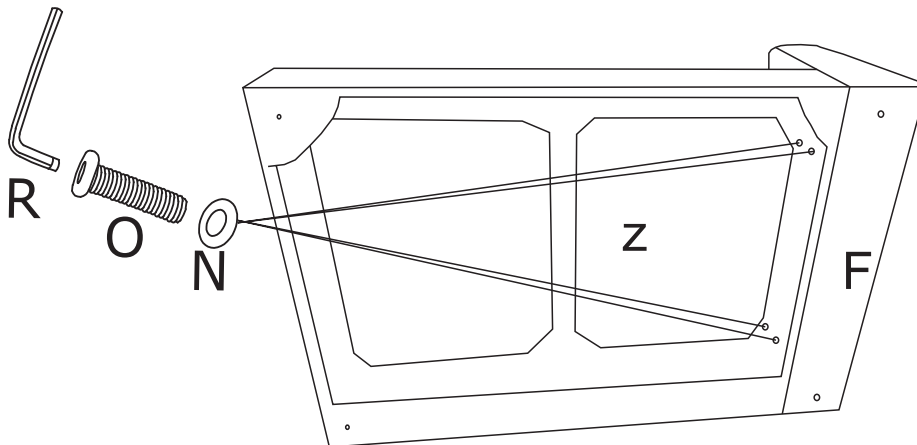

STEP 3: Assemble Seat Frame(A) and Seat Frame(Z) with Butterfly Nuts(T) Washers(N) and Bolts(I).

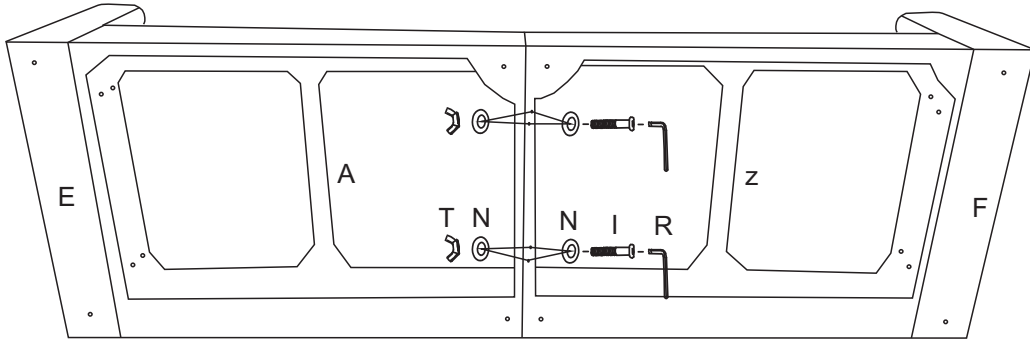

x8	
x4	
x4	

STEP 4: Install sofa legs, screw in Legs (M) and Gaskets (L).

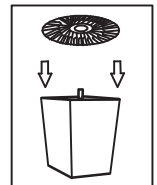
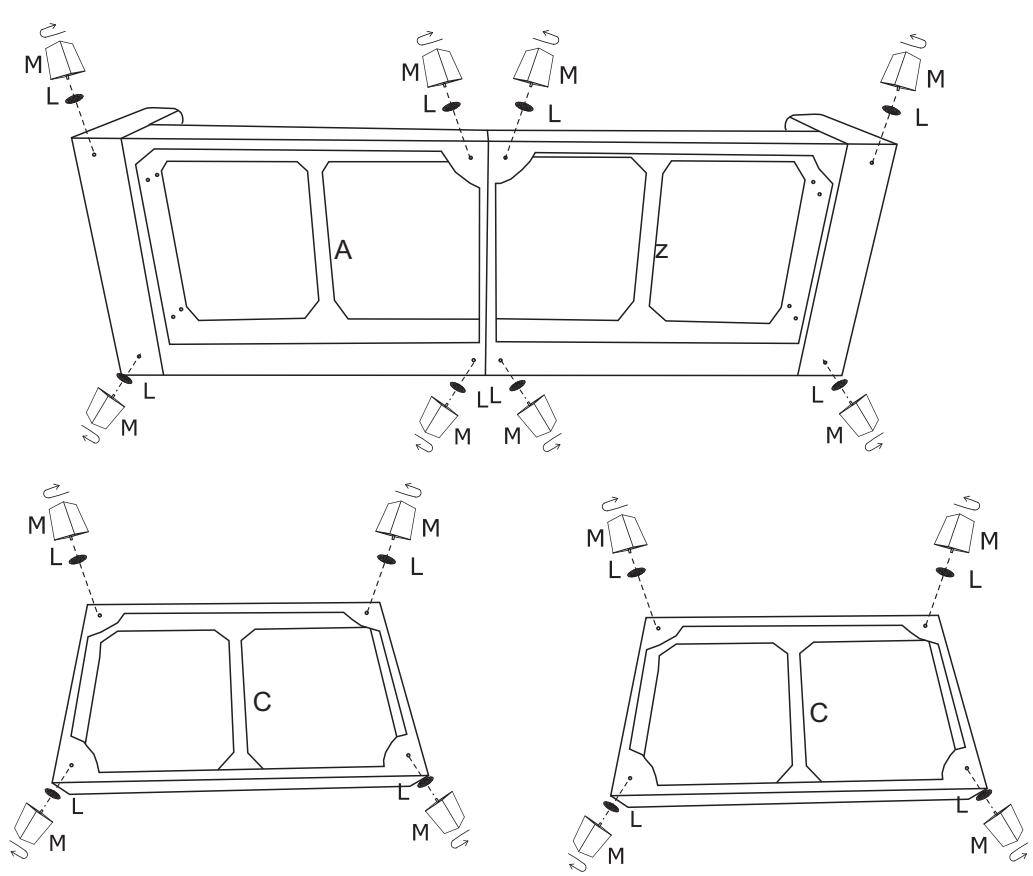

STEP 5 : Line up the holes in the Backrest (D) with corresponding holes on the frame. Insert Bolts (O) and Washers (N),tighten securely after the have all been placed.

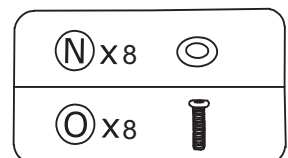
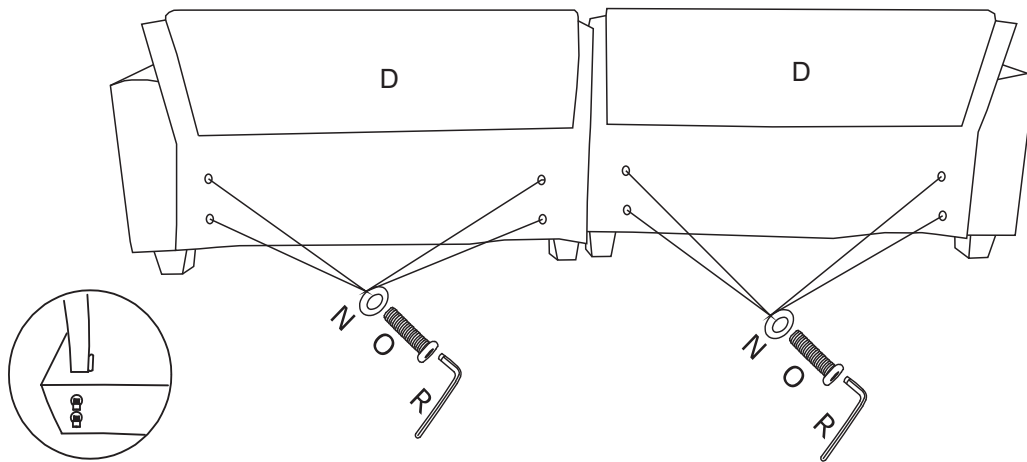

STEP6: Use scissors to open all the vacuum sealed cushions and arm pillows. It may take 48-72hrs to fully expand back to its original shape.

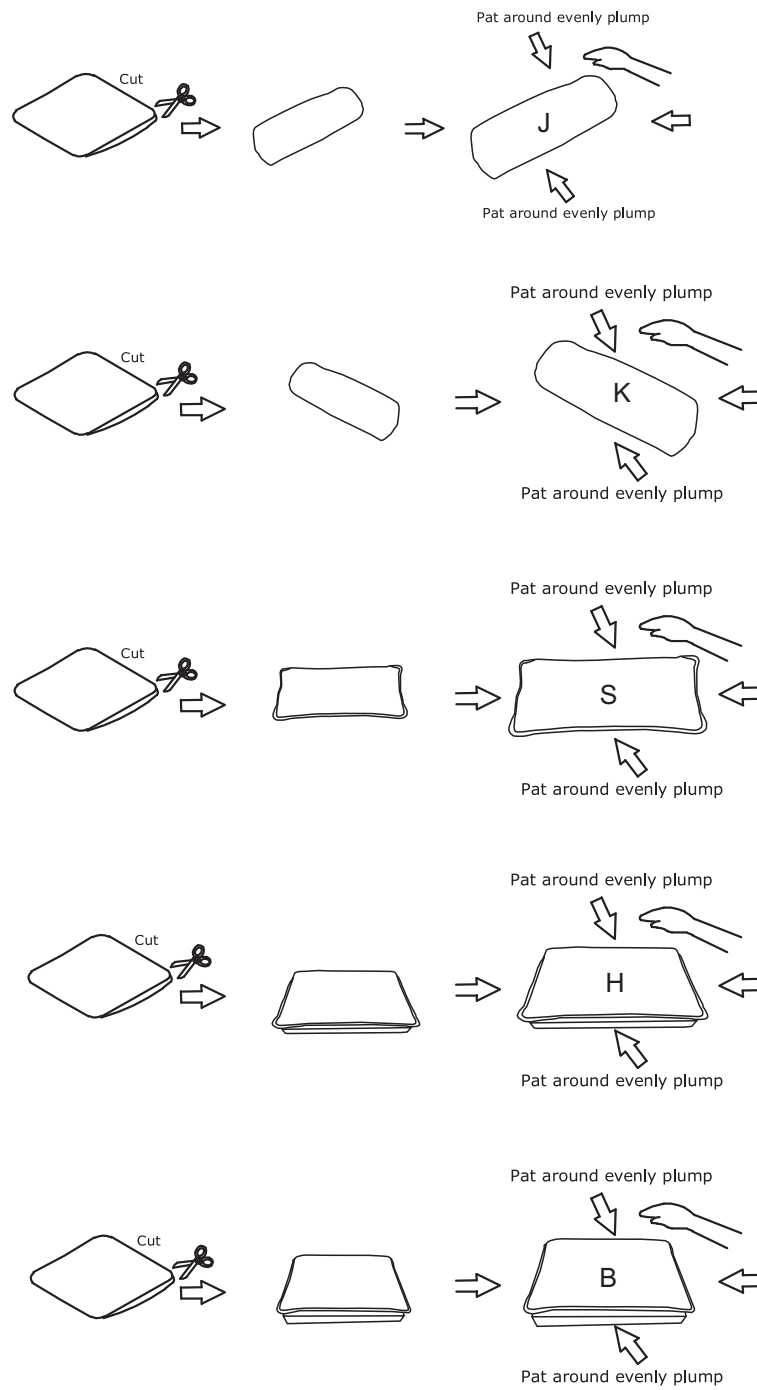

STEP 7 : Attach armrest (J&K) into designated position.

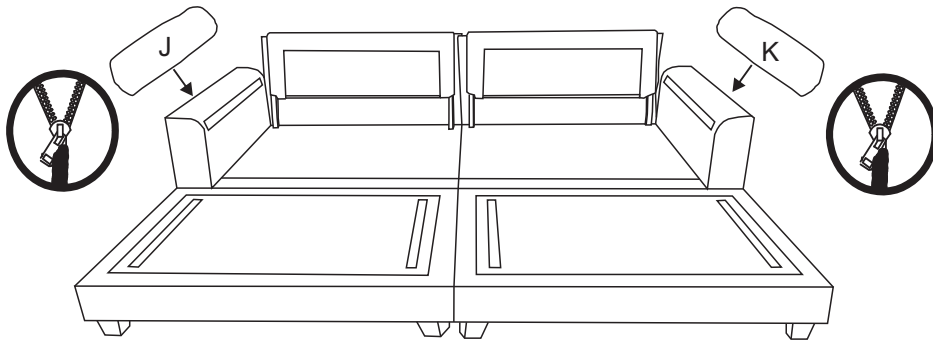

STEP 8: Add the cushions and you're done.

