



ASSEMBLY INSTRUCTIONS

MONIQUE COLLECTION





U502T-10 MONIQUE CHAIR

Thank you for purchasing this quality product. Be sure to check all packing materials carefully for small parts which may have come loose inside the carton during shipment. Identify and count all items and compare with the PARTS LIST and/or HARDWARE LIST shown below.





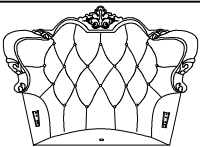

CAUTION: Read the instructions carefully before assembly.

1. We recommend that you assemble this product with the assistance of another person to eliminate damage to the product during assembly.
2. When you want to reposition the product, please always "LIFT & MOVE".

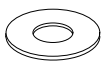
PARTS LIST

NO.	DESCRIPTION	SKETCH	Q'TY (PCS)
A	SEAT FRAME		1
B	LEFT SIDE FACING (LSF) ARM		1
C	RIGHT SIDE FACING (RSF) ARM		1
D	BACKREST		1
E	SEAT CUSHION		1
F	LEG		2

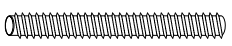
HARDWARE LIST

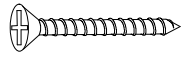
NO.	DESCRIPTION	SKETCH	Q'TY (PCS)
1	FLAT WASHER Ø5/16x3/4"		11
2	WASHER Ø5/16x1/2"		11
3	ALLEN KEY Ø5/16x3 1/4"		1
4	BOLT Ø5/16x3 1/4"		10
5	THREAD BOLT Ø5/16x3 1/4"		1
6	HEX NUT Ø5/16x1/2"		1
7	WRENCH 1/2"x 3 1/2"		1
8	SCREWS D4x 2 3/4"		4



ASSEMBLY INSTRUCTIONS

MONIQUE COLLECTION

U502T-10 MONIQUE CHAIR

STEP 1:

Place the seat frame (A) upside down. Assemble the legs (F) to both left and right back side of the seat frame (A) by using the Allen Key (3) with hardware 1, 2, and 4.

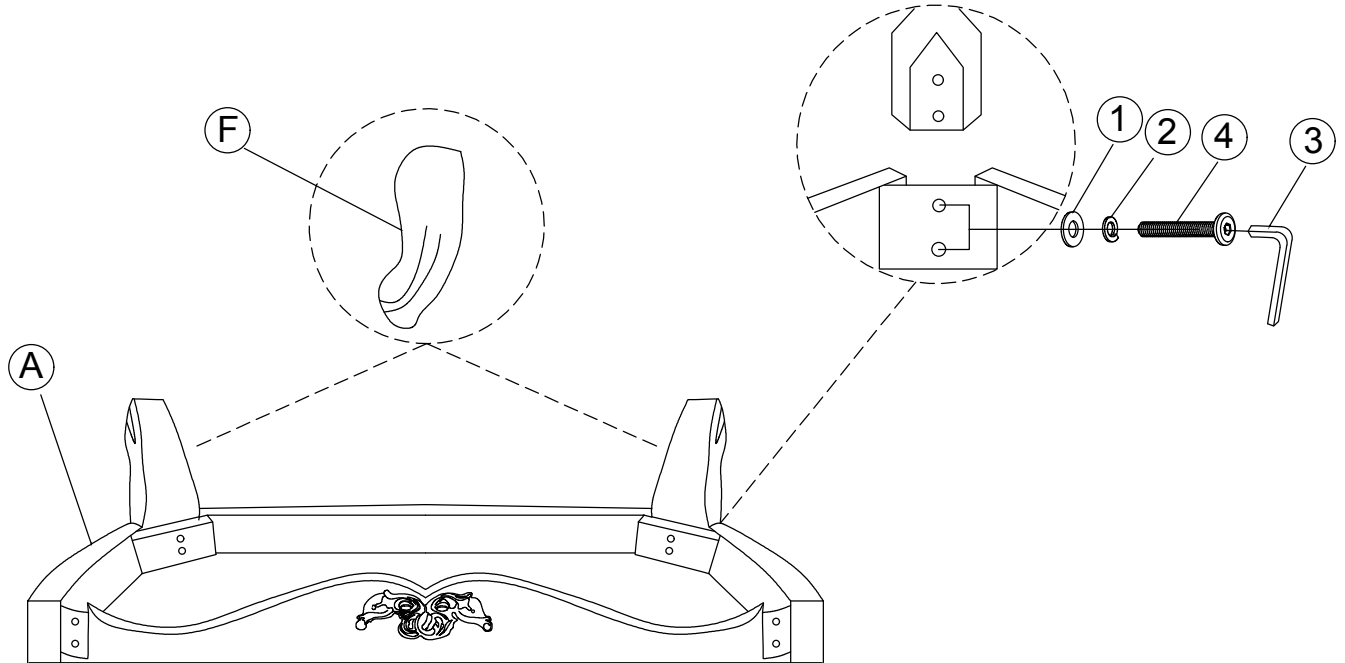

STEP 2:

Lay the seat frame (A) on its backside to reach the holes to secure the bolts for the arms. Align and assemble the LSF arm (B) and RSF arm (C) to the seat frame (A) by using the Allen Key (3) with hardware 1, 2, and 4.

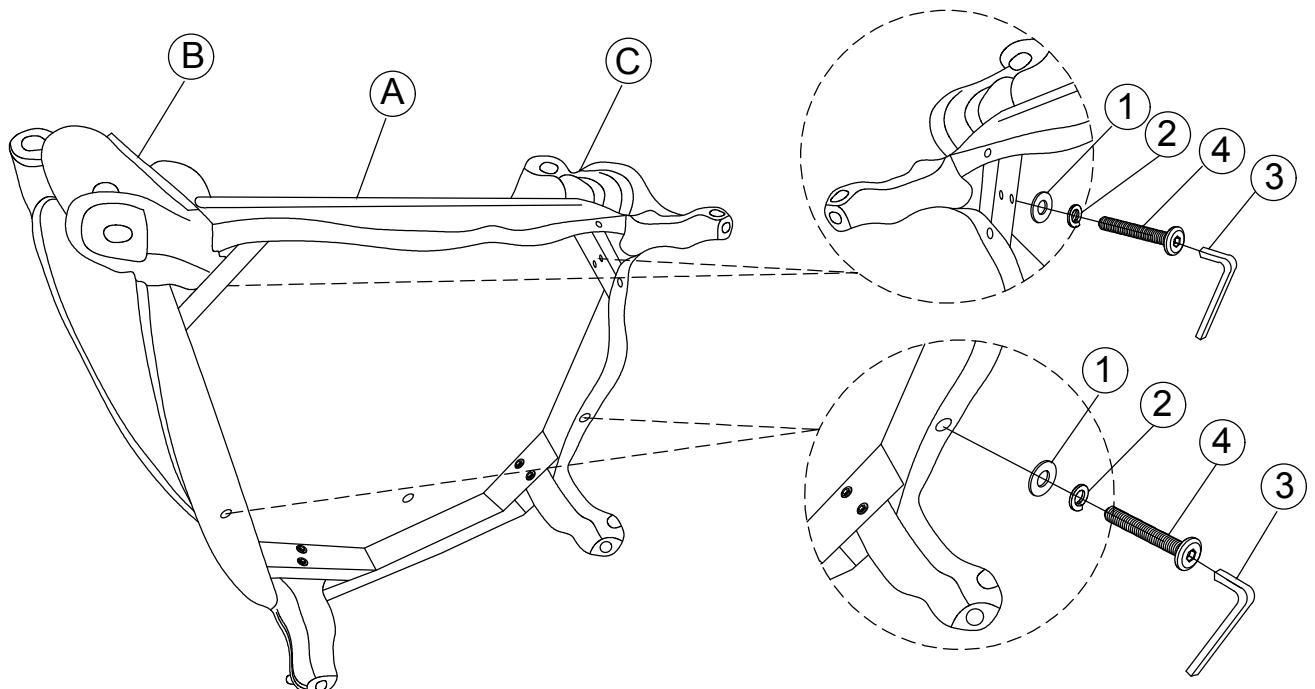

ASSEMBLY INSTRUCTIONS

MONIQUE COLLECTION

U502T-10 MONIQUE CHAIR

STEP 3:

Assemble and secure the front legs of the LSF arm (B) and RSF arm (C) to the seat frame (A) by using a screwdriver with hardware 8.

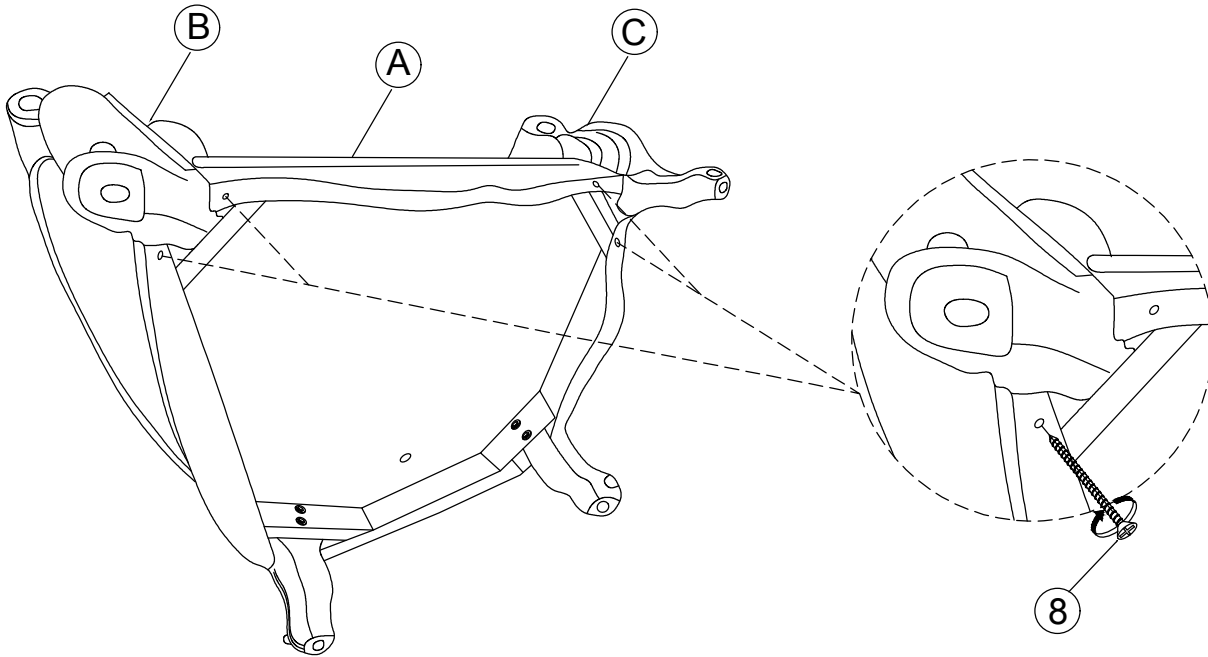

STEP 4:

Place the backrest (D) on its backside. Install the thread bolt (5) into the hole on the bottom of the backrest (D) by using your hands to rotate the bolt about 1/2 inches (25 mm) into the backrest (D).

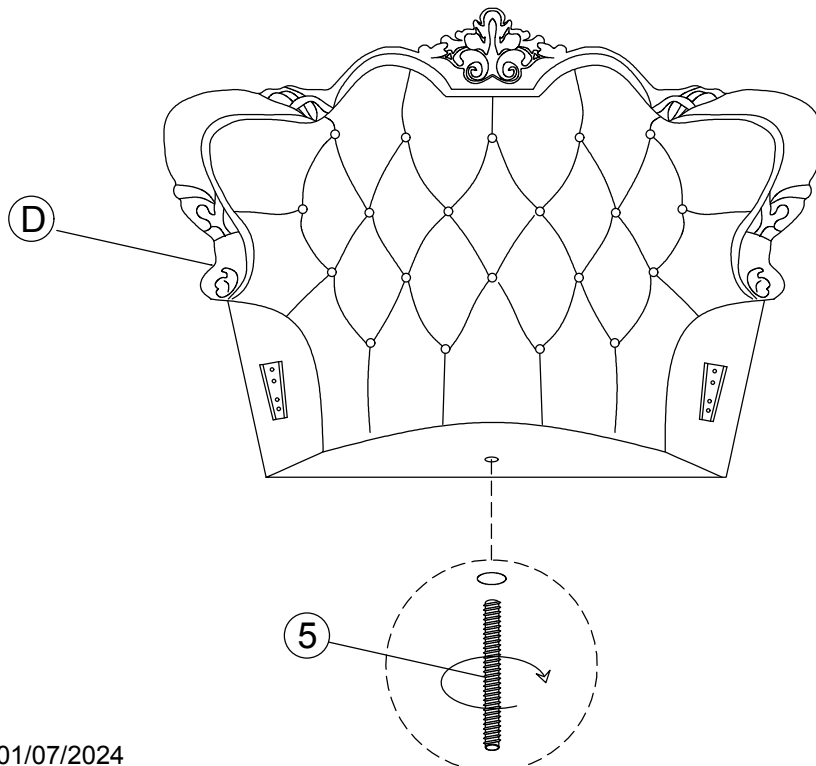

ASSEMBLY INSTRUCTIONS

MONIQUE COLLECTION

U502T-10 MONIQUE CHAIR

STEP 5:

Place the frame up right to install the backrest (D) with the LSF arm (B) and RSF arm (C) by align and slide the metal bracket on the backrest (D) to the metal brackets on the arms. Please make sure brackets are inserted all the way and secured.

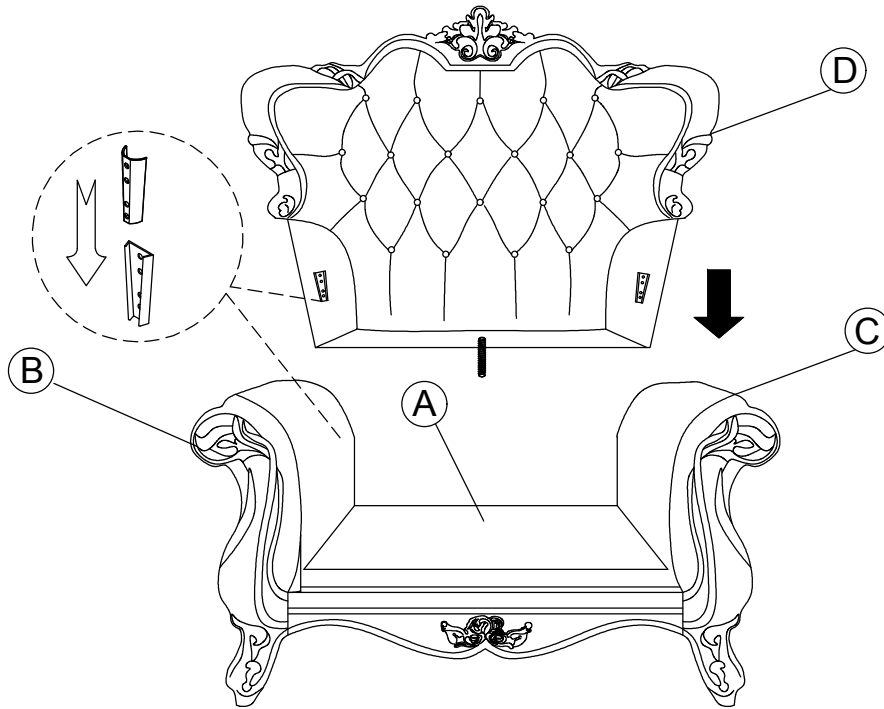

STEP 6:

Lay the upholstery on its back on a clean and soft surface to reach the thread bolt (5). Secure the backrest (D) to the seat frame (A) by using the Wrench (7) with hardware 1, 2, and 6

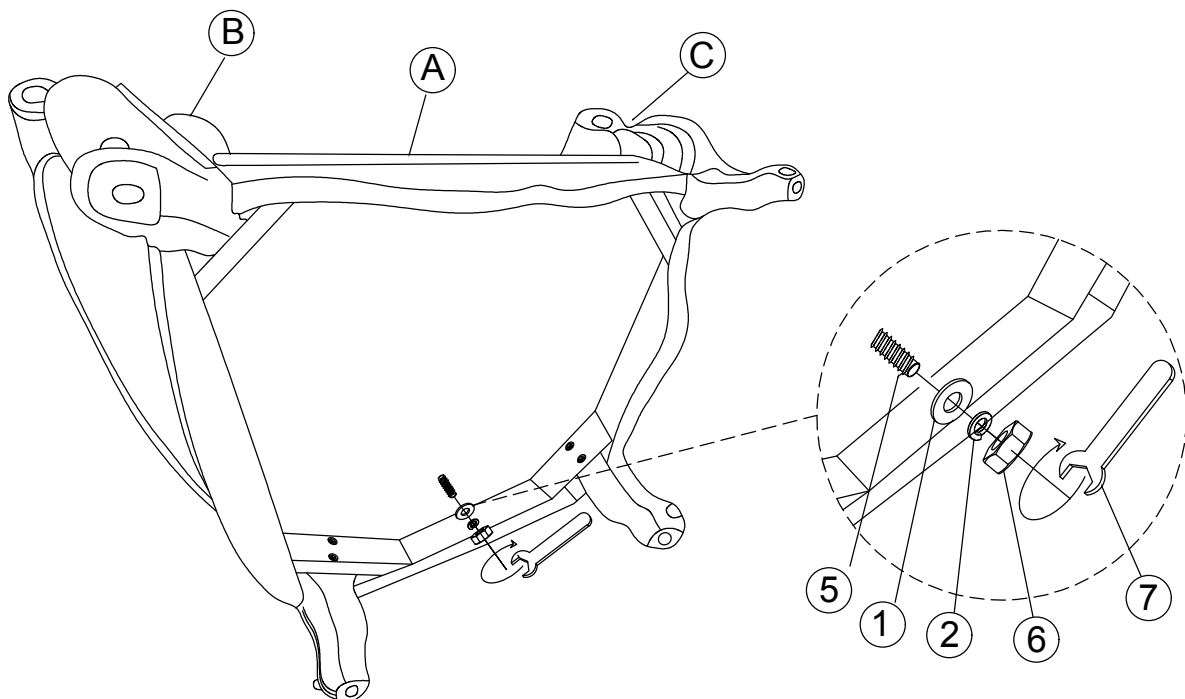

ASSEMBLY INSTRUCTIONS

MONIQUE COLLECTION

U502T-10 MONIQUE CHAIR

STEP 7:

Place the upholstery up right and install the seat cushion (E) to the seat frame (A).

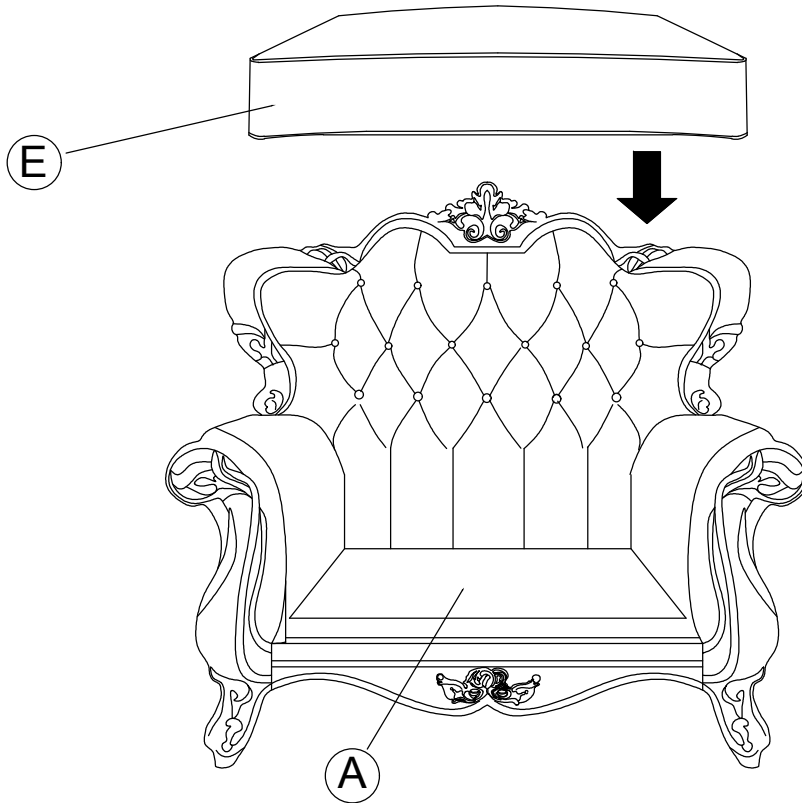

FINISH

