

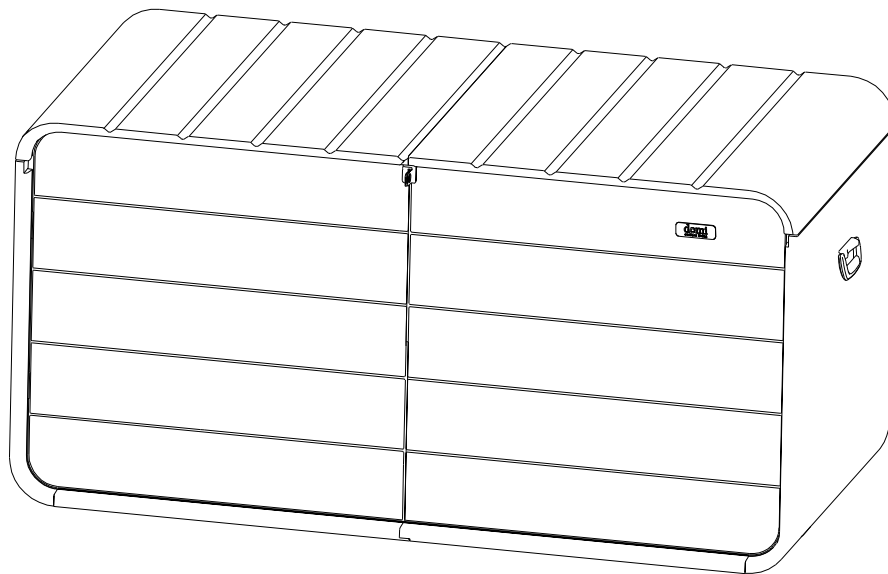

260 US GAL DECK BOX ASSEMBLY MANUAL



MODEL#: LNCZ0605

Missing part? Damaged? Contact us via email at

service@domioutdoorliving.com

www.domioutdoorliving.com

© Copyright 2023–2025 domi LLC. All Rights Reserved.

BEFORE STARTING ASSEMBLY



- ① Please check all parts and components to ensure that there are no damages or missing items BEFORE starting the construction of the product.
- ② For ease of construction, you may need a Power Drill (Cordless, Variable Speed).
- ③ It would be much easier to assemble the product with two or more people.
- ④ Some parts have metal edges. Please be careful when handling components.

IMPORTANT: Please contact Customer Service if you have any problems or discover any missing parts.

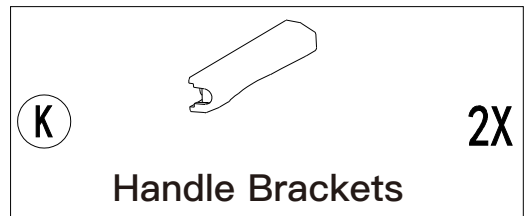
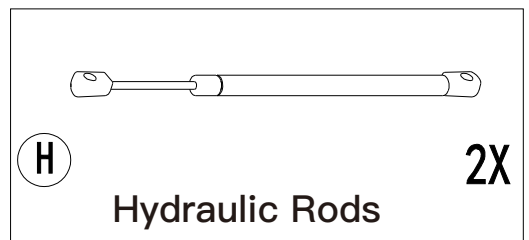
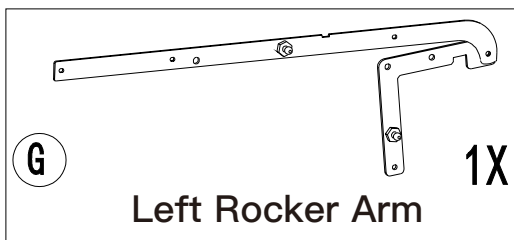
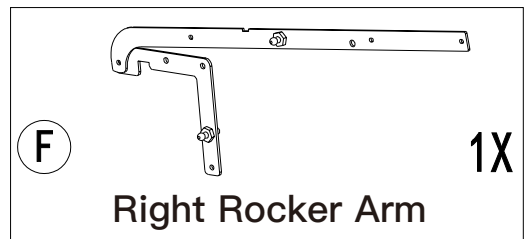
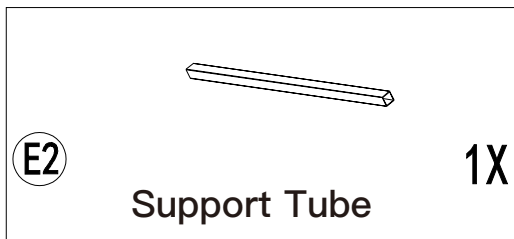
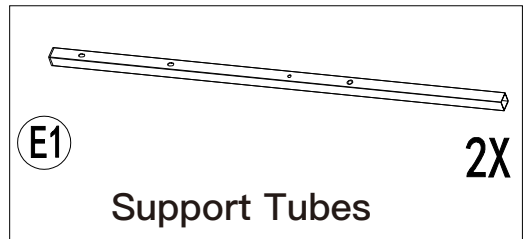
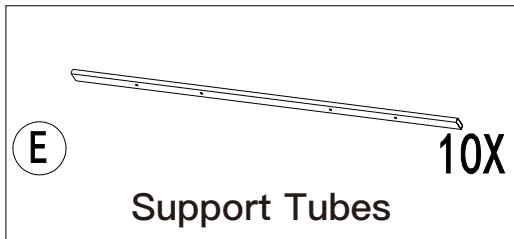
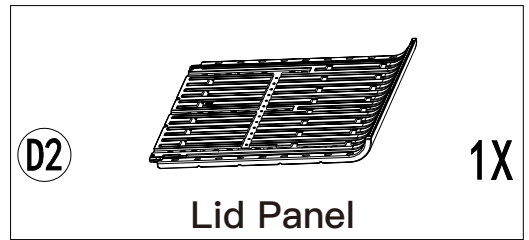
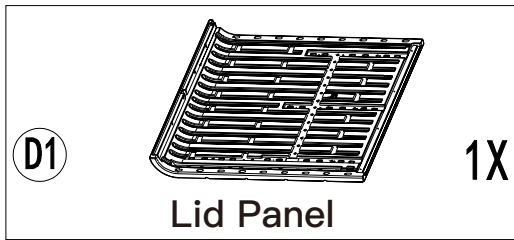
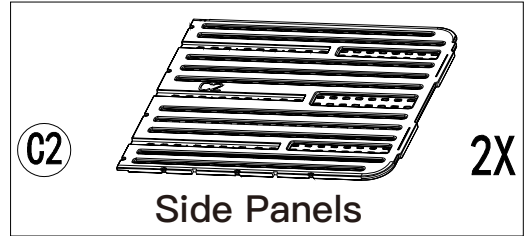
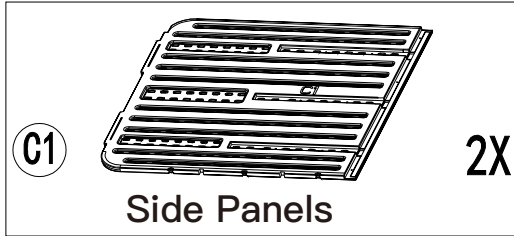
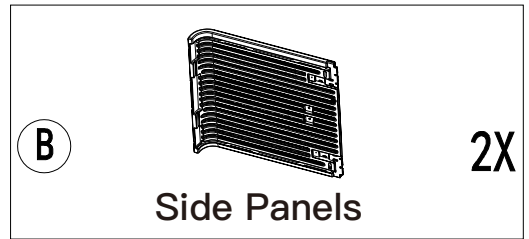
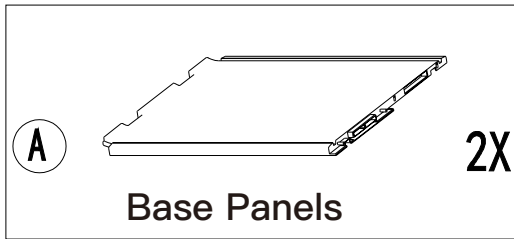

USA & Canada:
1-833-807-3550





 <p>L 1X Stainless Steel Small Lock Plate</p>	 <p>L1 1X Label</p>
---	---

 <p>M 1X Stainless Steel Lock Bracket</p>

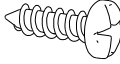
 <p>N 30X ST5*15 screws</p>

 <p>N1 40X ST5*20</p>

 <p>P 4X M6 nuts</p>
--

 <p>Q 8X ST6*16 screws</p>
--

 <p>R 18X M6*16 bolts</p>

 <p>R1 4X M6*30</p>

 <p>S 8X ST5*25 screws</p>
--

 <p>U 4X M5 washers</p>

 <p>V 1X Hex wrench</p>

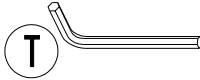
 <p>T 1X Allen Key</p>
--

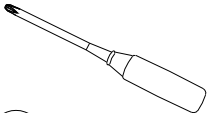
 <p>W 1X Screwdriver</p>
--



Base Panels Assembly

A 2X

Step 1:

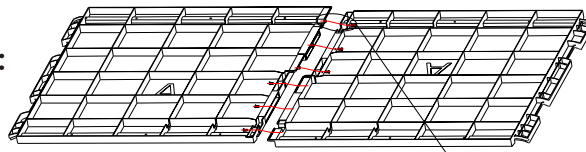

N ST5*15 6X

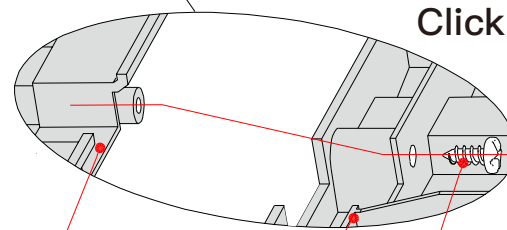
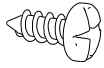

N1 ST5*20 8X



E 2X

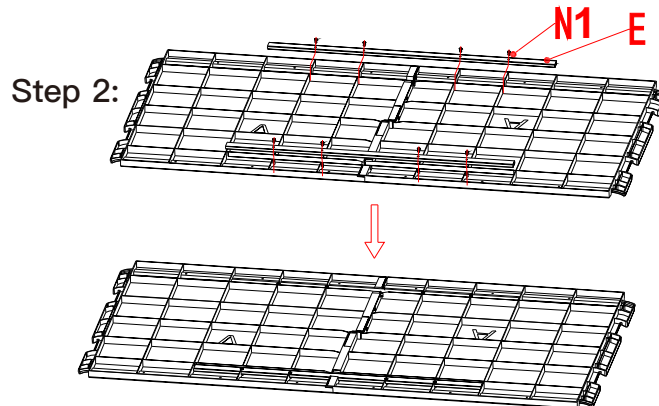



Step 1:

Attach the 2 Base Panels #A together. Secure them with 6 screws #N(ST5*15).

Step 2:

Insert the 2 Support Tubes #E into the grooves on the base panel. Secure each #E with 4 screws #N1(ST5*20).

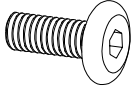
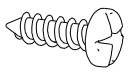
	C1	2X
	C2	2X
	E	6X
	R	M6*16 8X
	N1	ST5*20 24X
4		

Front and rear Panels Assembly

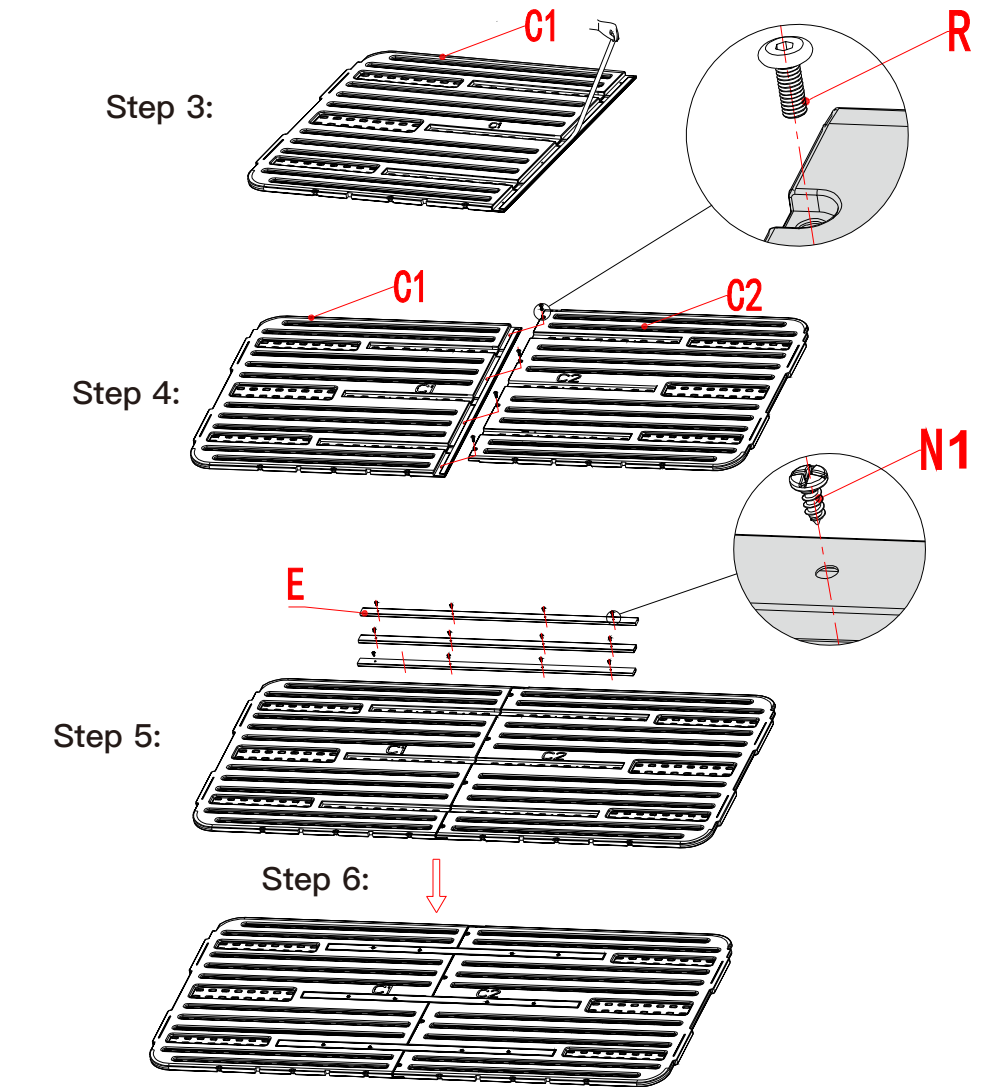



Step 3:
Peel off the adhesive strip from the Side Panel #C1.

Step 4:
Attach the Side Panel #C1 and #C2 together. Secure them with 4 bolts #R(M6*16).

Step 5:
Insert the 3 Support Tubes #E into the grooves on the side panels. Secure each #E with 4 screws #N1(ST5*20).

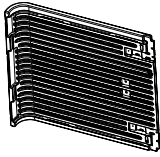
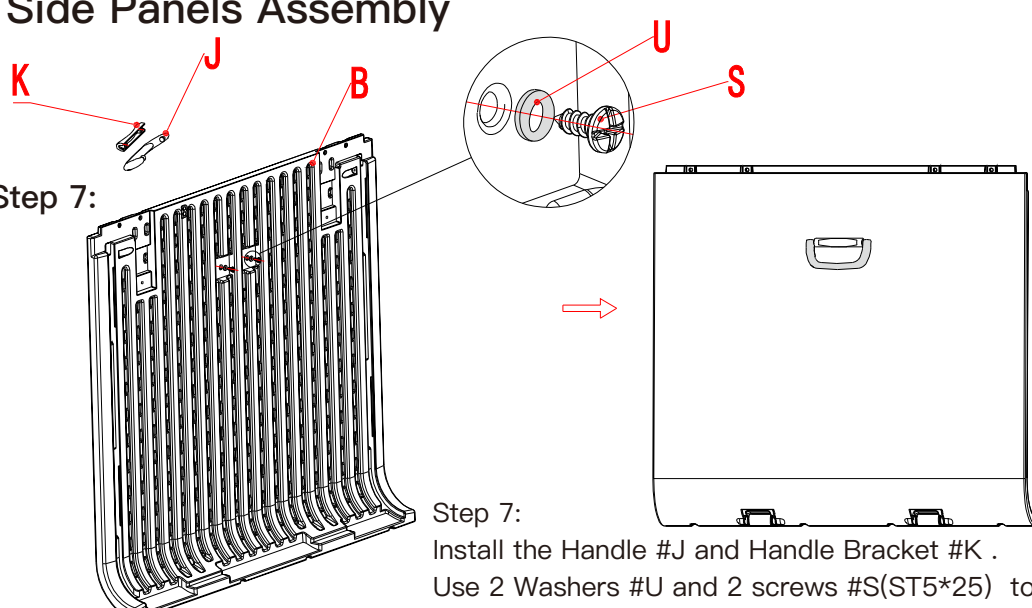
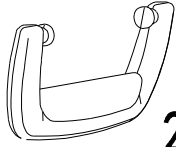
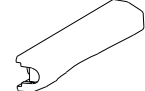
Step 6:
Repeat above procedures to install another set of #C1 and #C2 with #E.

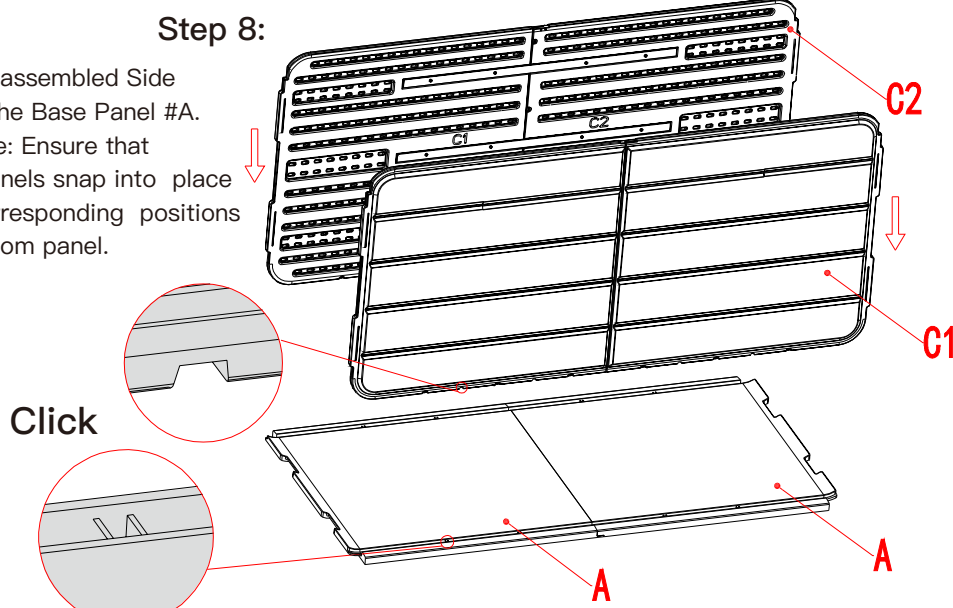
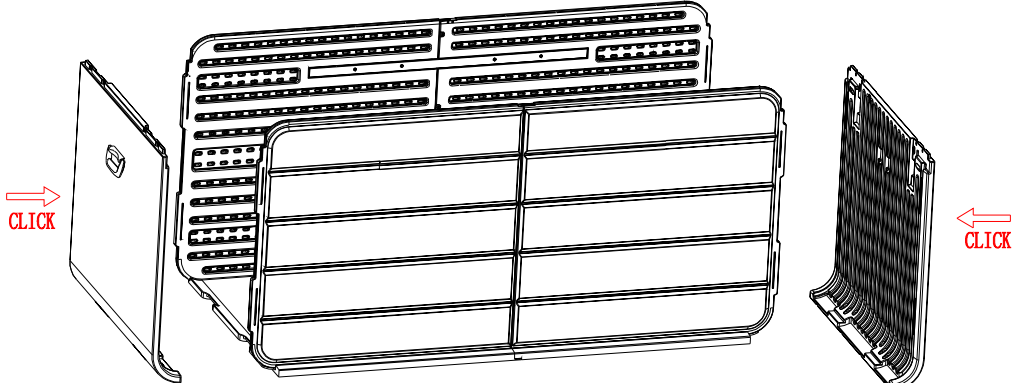
 <p>B 2X</p>	<h3>Side Panels Assembly</h3>  <p>Step 7:</p> <p>Step 7: Install the Handle #J and Handle Bracket #K . Use 2 Washers #U and 2 screws #S(ST5*25) to secure the Handle #J and Handle Bracket #K to the Side Panel #B as shown.</p>
 <p>J 2X</p>	
 <p>K 2X</p>	
 <p>S ST5*25 4X</p>	
 <p>U M5 4X</p>	
<p>Step 8: Attach the assembled Side Panels to the Base Panel #A. Please note: Ensure that the side panels snap into place at their corresponding positions on the bottom panel.</p>	<p>Step 8:</p>  <p>Click</p>
	 <p>CLICK</p>
<p>5</p>	

Step 9:

Insert 4 screws #S(ST5*25) into the holes in the panel #B , then tighten to secure panel #B to panel #C2 and #C1.

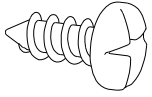

ST5*25

S

4X

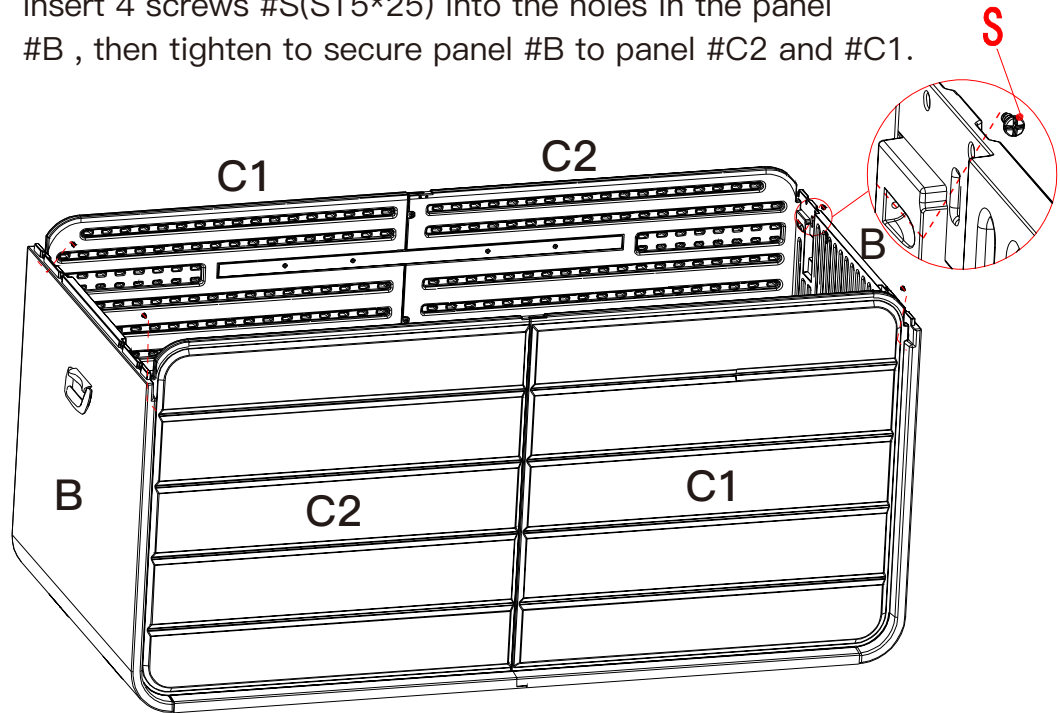

Step 10:

Flip the deck box with the Base Panel #A facing up.

Use 20 screws #N(ST5*15) to secure the bottom panel with side panels.

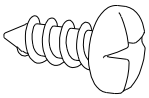







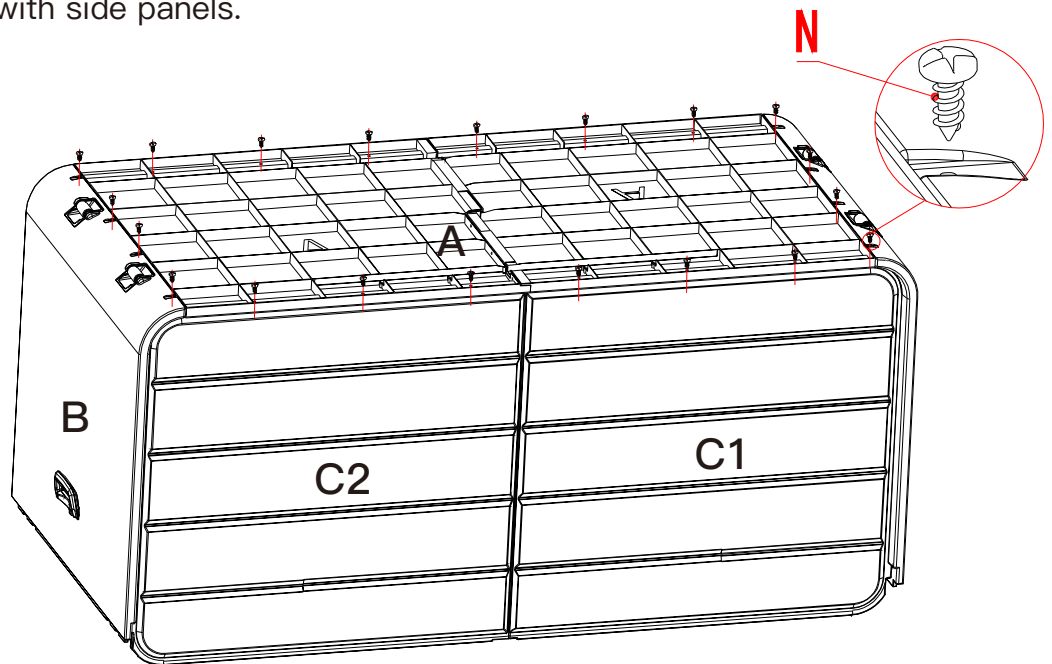

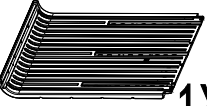

ST5*15

N

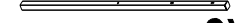
20X



6

D1		1X
D2		1X
E		2X
E1		2X
E2		1X
R		M6*16 4X
R1		M6*30 4X
N		ST5*15 2X
N1		ST5*20 8X
L		1X

Lid Panels Assembly

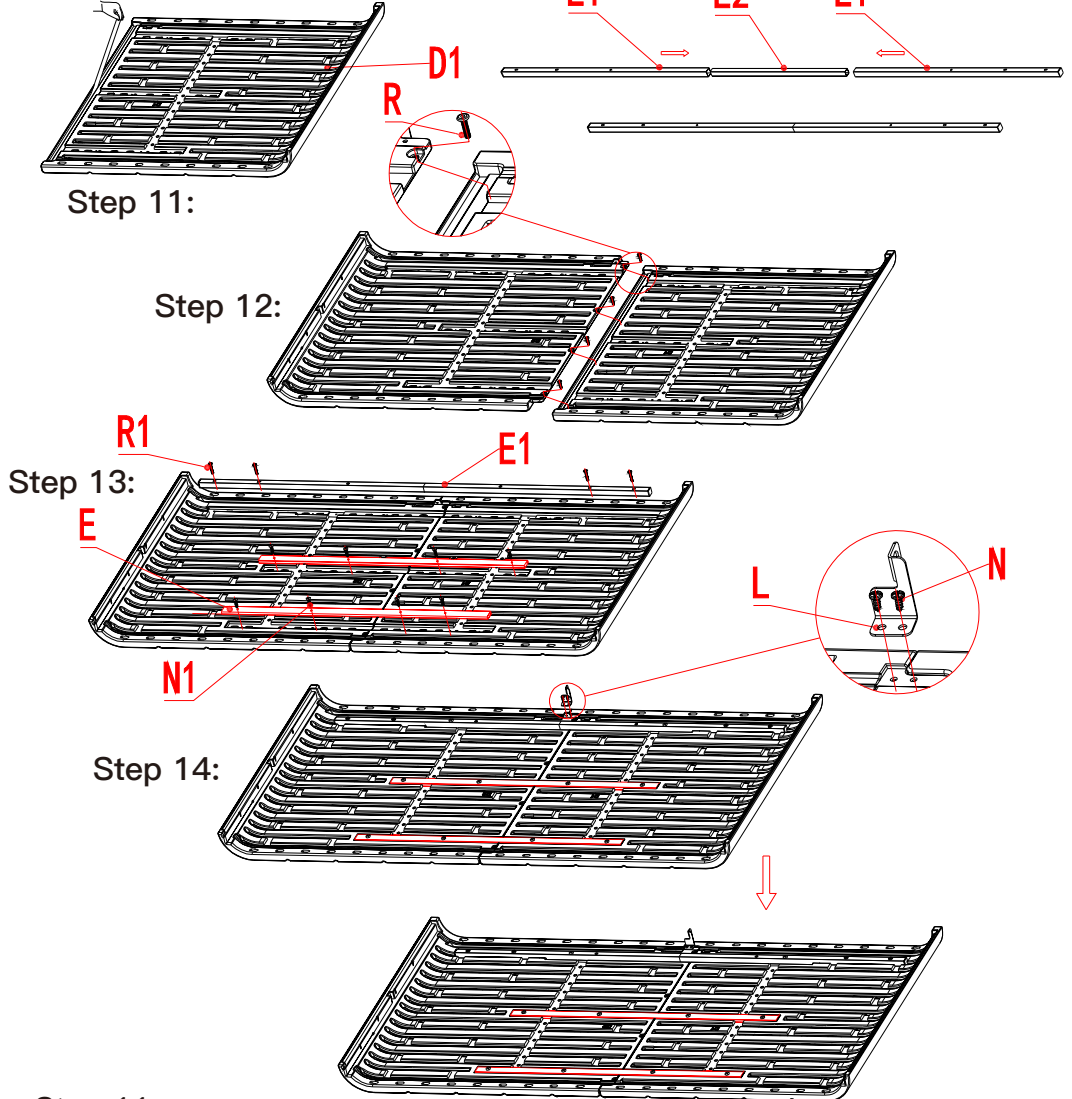



Step 11:
Peel off the adhesive strip from the Lid Panels #D1 .

Step 12:
Attach the Lid Panels #D1 and #D2 together. Secure them with 4 bolts#R (M6*16).

Step 13:
(1) Insert support tube #E2 into 2 part #E1, Use 4 bolts #R1 to secure the assembled support tube into the grooves as shown.
(2) Insert the 2 Support Tubes #E into the grooves on the Lid Panels. Secure each #E with 4 screws #N1 (ST5*20).

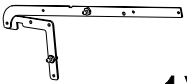
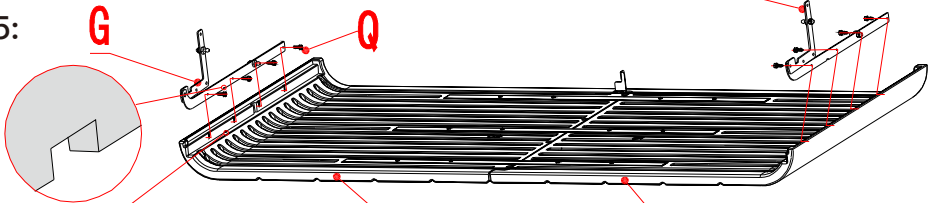
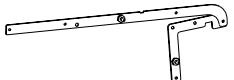
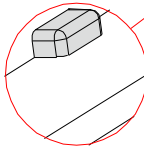
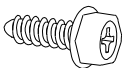
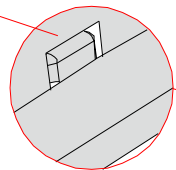
Step 14:
Install the Stainless Steel Small Lock Plate #L onto the Lid Panels as shown. Secure it with 2 screws #N (ST5*15).

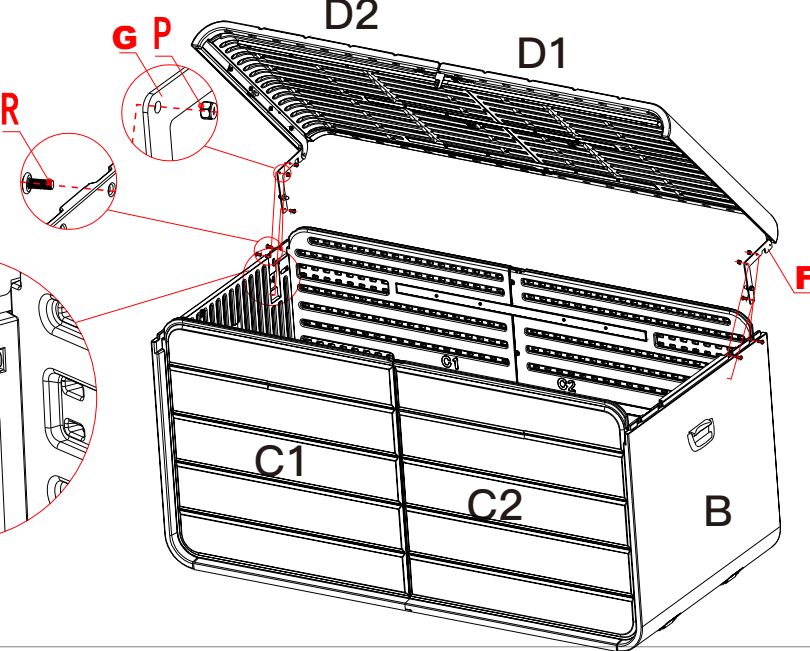
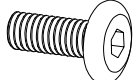
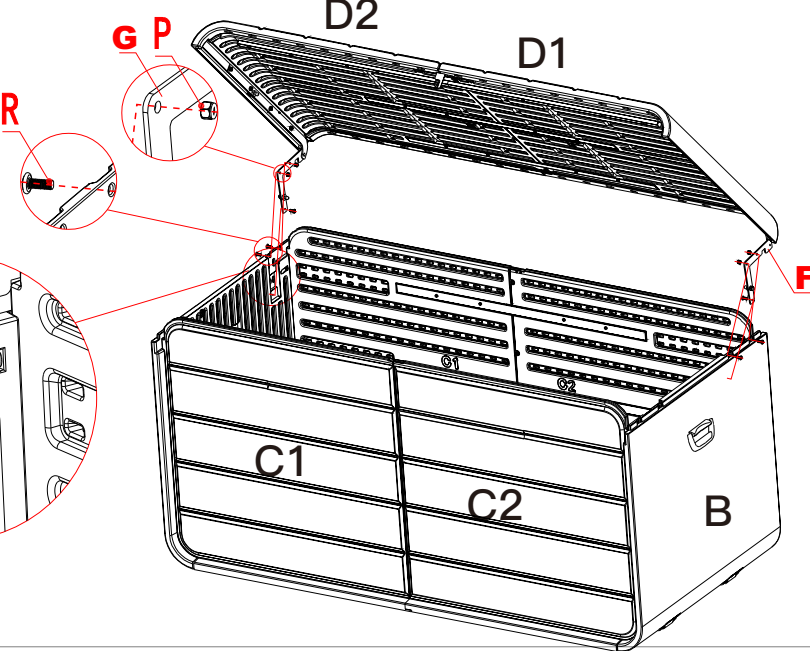
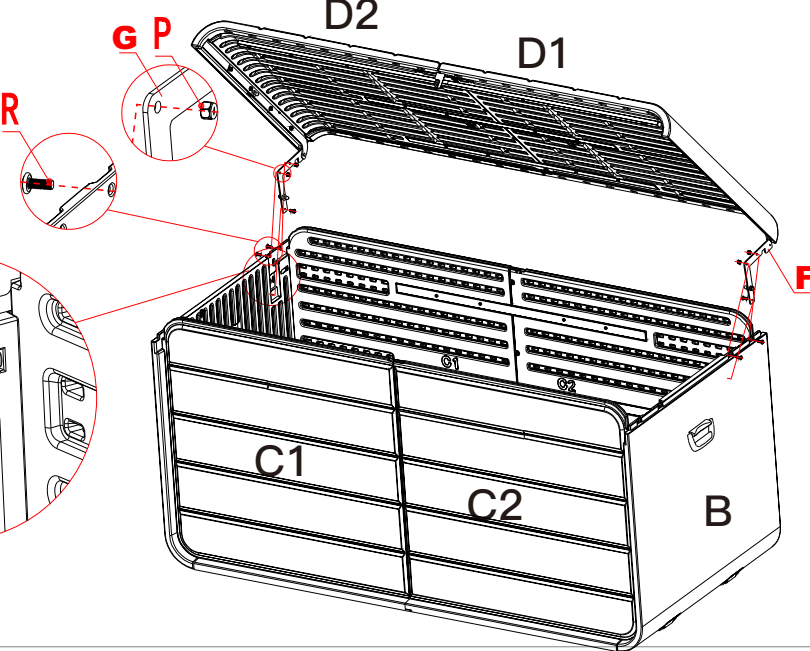
<p>F 1X</p> 	<p>Step 15:</p> 
<p>G 1X</p> 	<p>D2 D1</p> 
<p>Q 8X</p> <p>ST6*16</p> 	<p>Please ensure the notch on the rocker's arm aligns carefully with the corresponding protrusion on the Lid Panels. It is important to make sure they fit together correctly! Also, please look at the image for the correct alignment of Stainless Steel Small Lock Plate #L and the Rocker Arms at their respective positions.</p>  <p>Step 15: Install the Right Rocker Arm #F onto the Lid Panel #D1; Install the Left Rocker Arm #G onto the Lid Panel #D2.</p>
<p>P 4X</p> <p>M6</p> 	<p>Step 16: Use bolt #R(M6*16) and nut #P to connect part #G and #F under the lid to the side panel #B as shown. (you can install the lid on either side)</p> 
<p>R 6X</p> <p>M6*16</p> 	
<p>8</p>	

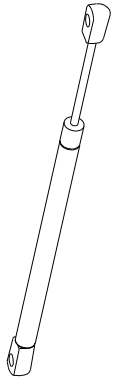

H

2X

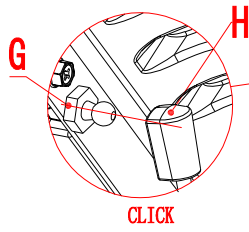

Step 17:
Click the Hydraulic
Rods #H into the
rocker arm #F and
#G as shown.

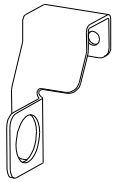
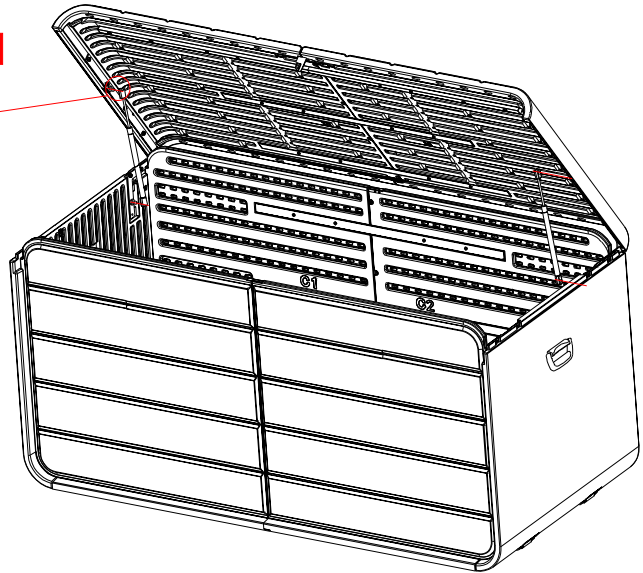

M

1X

Step 18:
Use screws #N(ST5*15) to fix Stainless Steel Lock
Bracket #M to the front panel(from inside to outside).

INSIDE VIEW

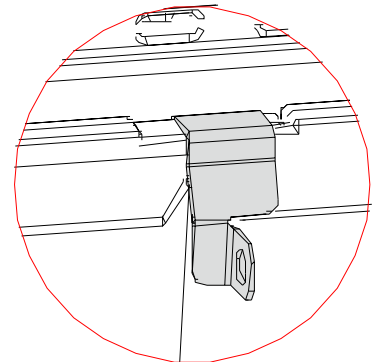
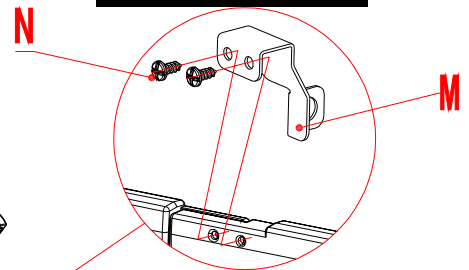

OUTSIDE VIEW

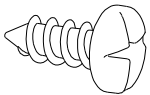

N

ST5*15

2X

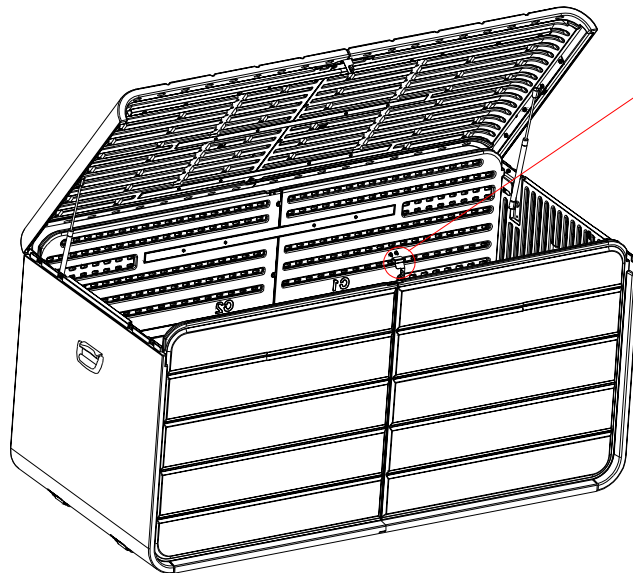



L1

1X

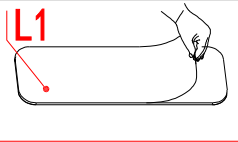

(1)

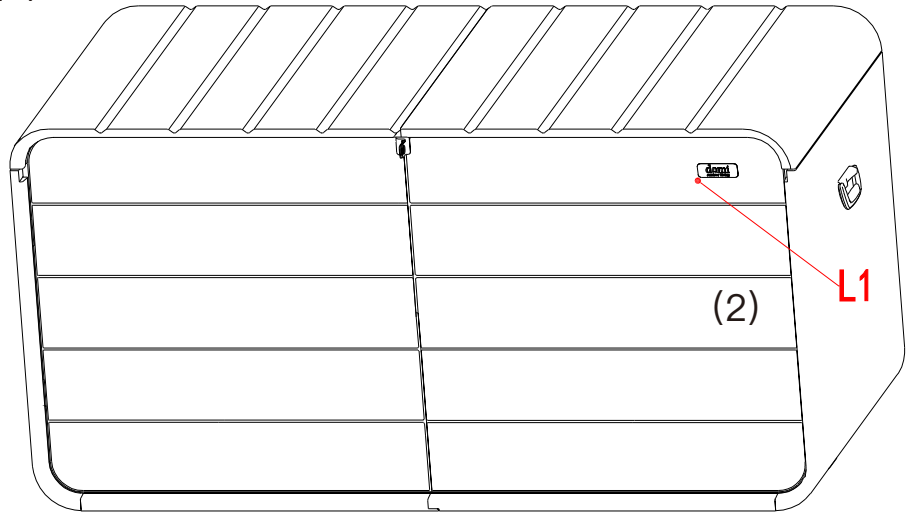

Step 19:

- (1) Remove the backing strip from Label #L1.
- (2) Stick Label #L1 onto the outer side of the deck box.

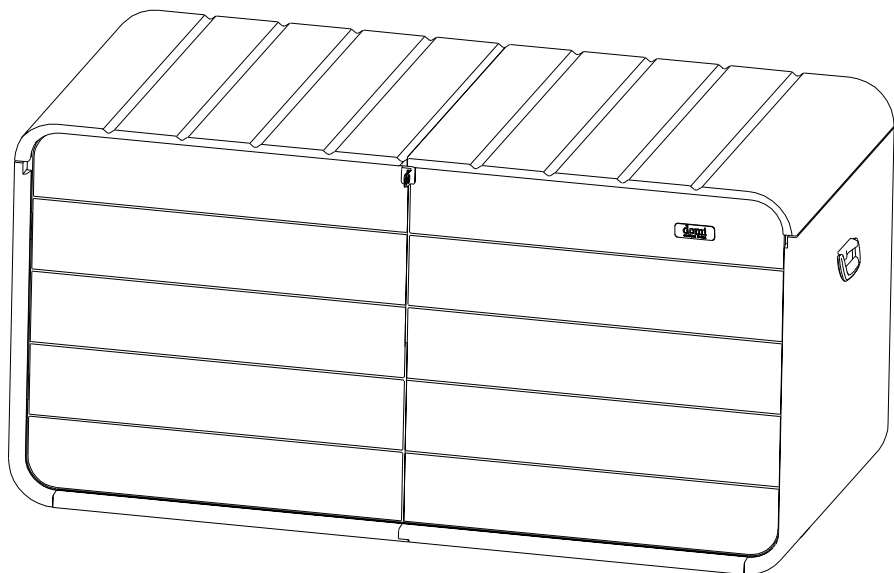



Thanks for your purchase.

At domi outdoor living, we believe in our products.

That's why we provide a 12-month warranty and friendly, easy-to-reach after-sales service. So, if you have any questions about our product or assembly, please feel free to contact us. We are here for you.

Support:  

After-sales contact email:

service@domioutdoorliving.com

Business cooperation contact email:

marketing@domioutdoorliving.com

Please have your order ID available if you reach out for support.

If you have damaged parts or product, please send us photos for an immediate response.