

# Rattan Laundry Hamper

## Instruction Manual

ZYL-BT90

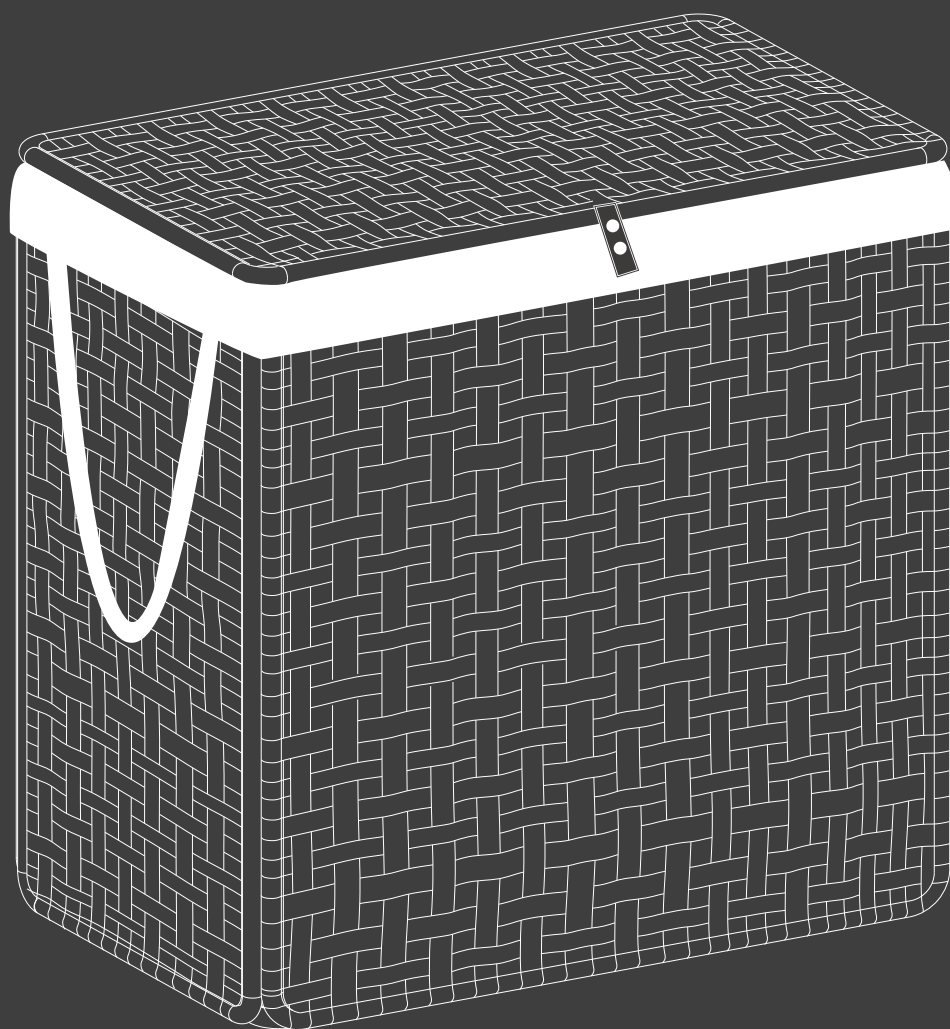

## **General Guidelines**

- Please read the following instructions carefully and use the product accordingly.
- Please keep this manual and hand it over if you transfer the product.
- This summary may not include every detail of all variations and steps to be considered. Please contact us when further information or help is needed.

## **Warnings**

- To avoid damage to the product, please do not force clothes into the basket.
- If there are any defective or missing parts after unpacking, please cease assembly immediately and contact us.

# 1 Component List

---

**A**

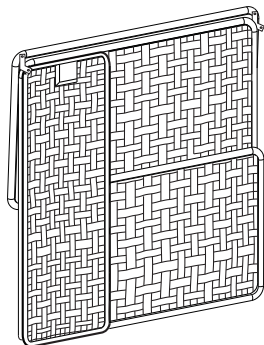

**x1**

**B**

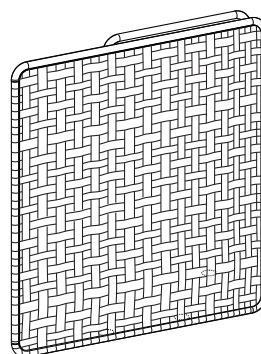

**x1**

**C**

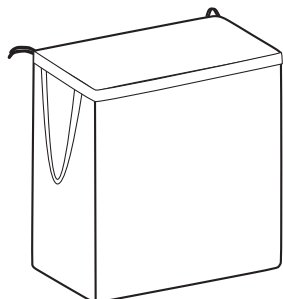

**x1**

# 2 Hardware

---

**1**

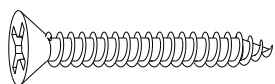

**x2**

**2**

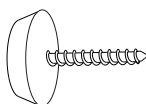

**x2**

**3**



**x1**

# Step 1

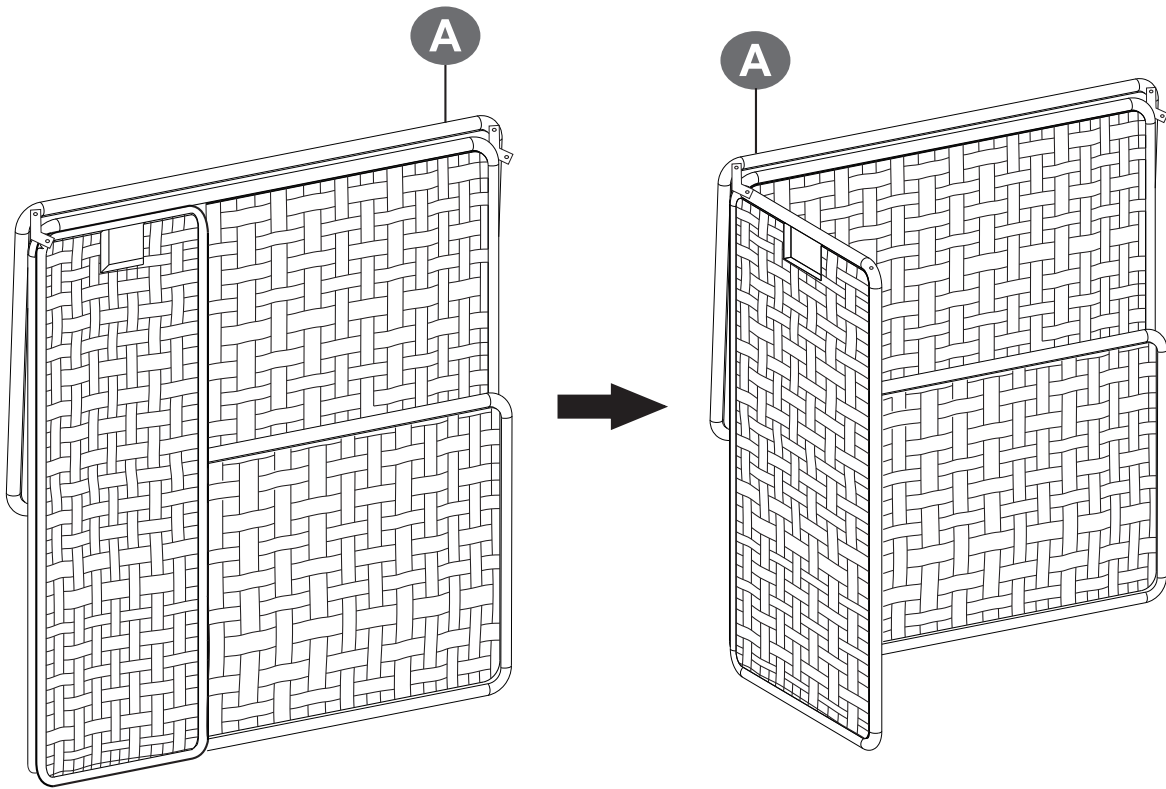

# Step 2

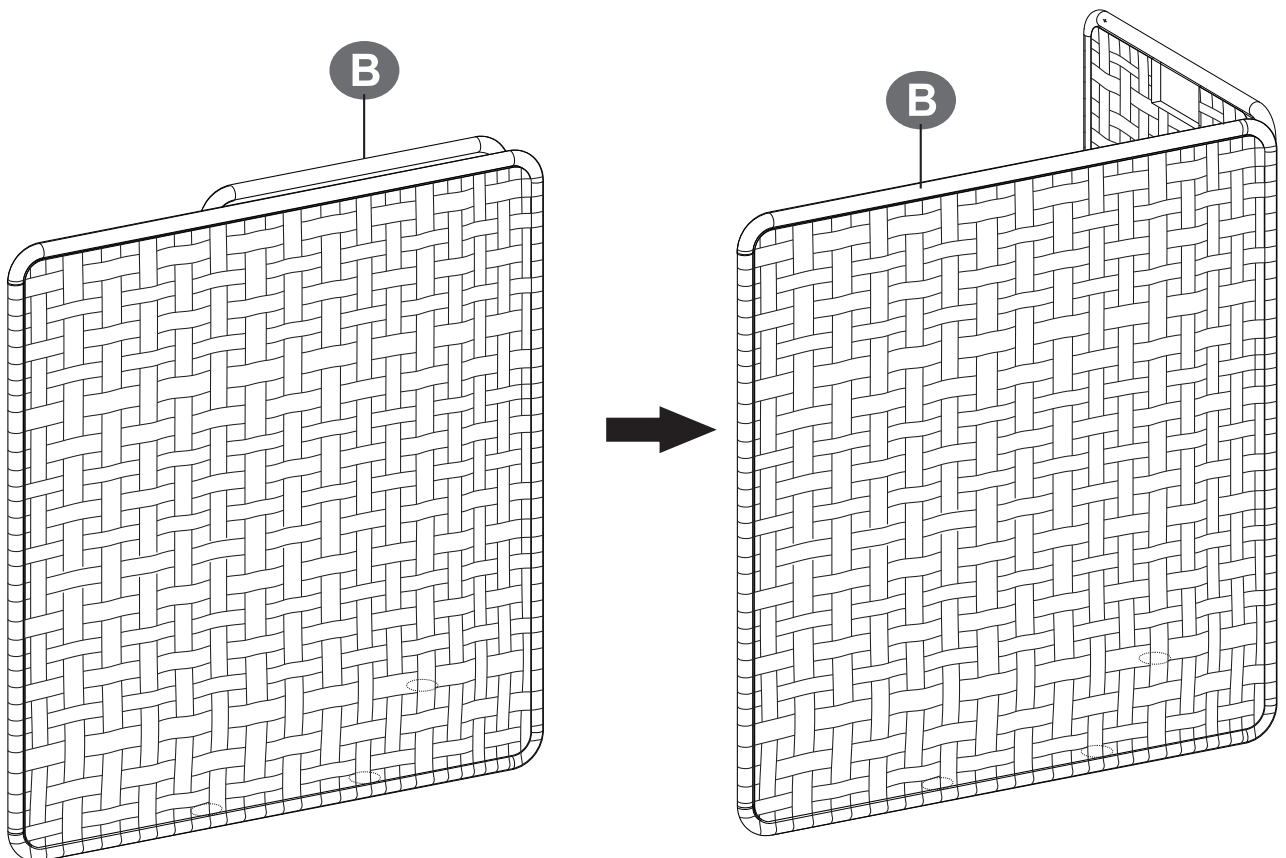

## Step 3

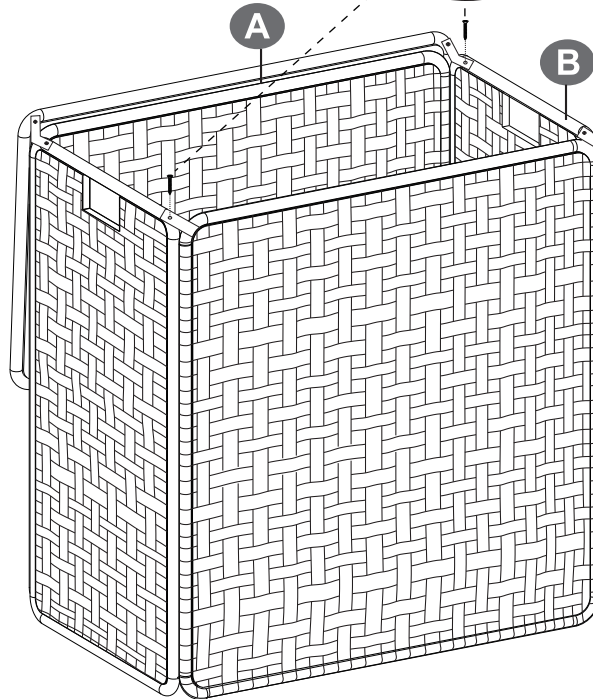
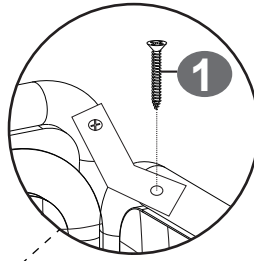
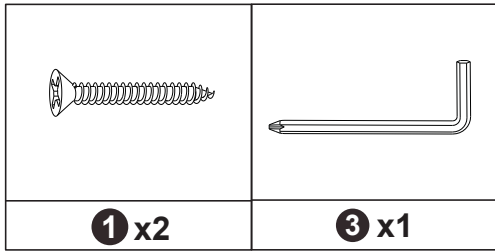

## Step 4

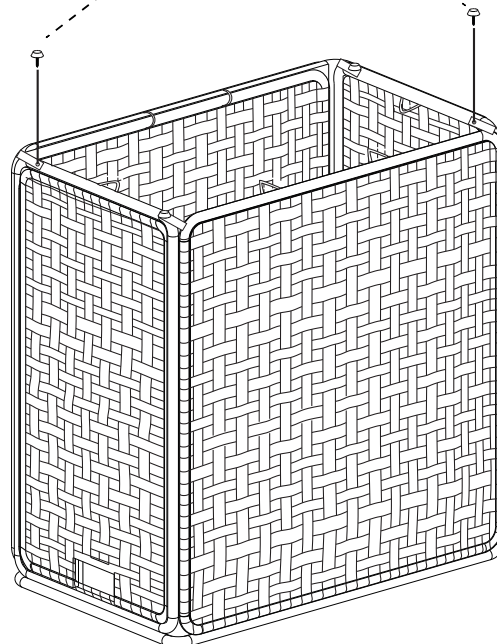
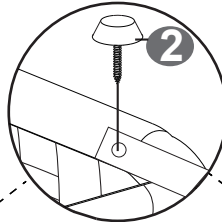
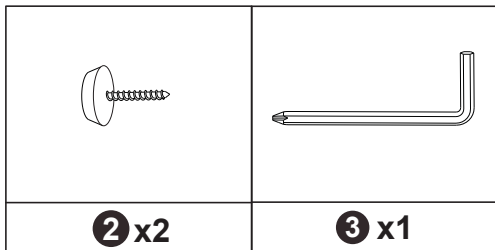

**Note:**  
Do not tighten the screw  
to the bottom of the rubber.

Flip the Rattan Laundry Hamper 180°

# Step 5

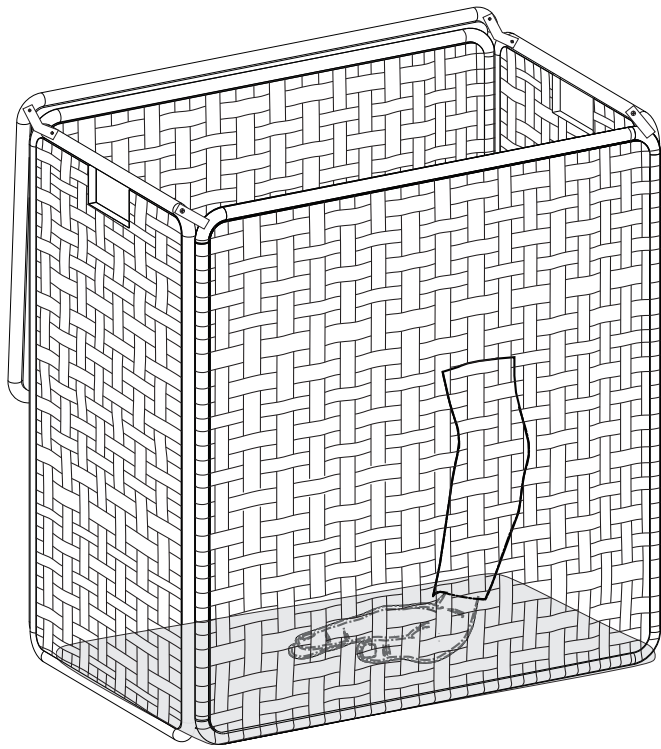

Place the bottom panel horizontally.

# Step 6

