

ASSEMBLY INSTRUCTION



This instruction booklet contains important safety information. please read and keep for future reference.

This sofa collection work as modular sofa function,it can be a single sofa , 3 seater sofas,L shape sofas,ottoman,sofa sets with buying different sections of the sofas and combine them together. You can decide to buy more components according to your living room size.

To ensure safe and satisfactory use of this product,please carefully read the below instructions beforehand.

- 1.This sofa ships in several boxes,we recommend unpacking and starting assembly when several boxes are received.
- 2.Our cushions are vacuum packed for convenient shipping. Please allow 2-3 days for them to fully expand to their original shape and for any wrinkles to disappear.
- 3.In the event that a part is damaged or missing,no need to return the product,we will gladly help and ship your replacement parts free of charge.



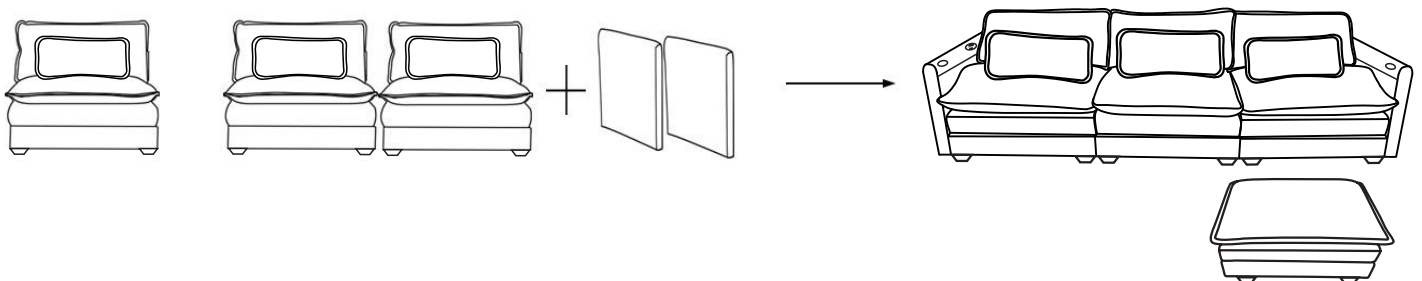







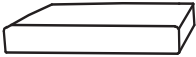

Below are some guidelines for you how you can do mix and match.

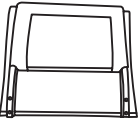

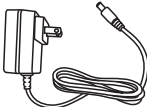





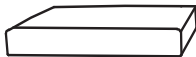

IF YOU BUY 3 SEATER SOFA
please follow below assembly instruction

Parts incidued

Parts List (BOX 1)

A Seat frame  2PCS	B Seat cushion  2PCS	C Back Cushion  2PCS	E Pillow  2PCS
F Backrest  2PCS	G Leg  8PCS	L Charger  1PC	N Washer  52PCS
O M8*60mm Bolt  36PCS	P M8*80mm Bolt  8PCS	Q Butterfly Nut  8PCS	R Alley Key  1PC

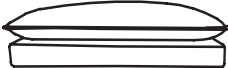
Parts List (BOX 2)

A Seat frame  1PC	B Seat cushion  1PC	C Back Cushion  1PC	E Pillow  1PC
F Backrest  1PC	G Leg  8PCS	O Ottoman cushion  1PC	N Ottoman frame  1PC

PART LIST & HARDWARE

Parts List (BOX 3)

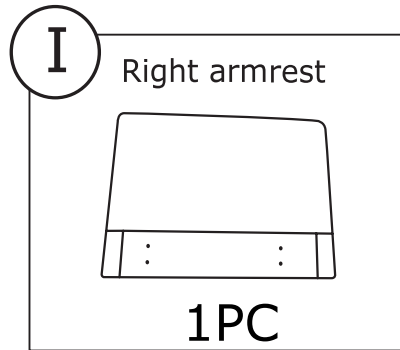
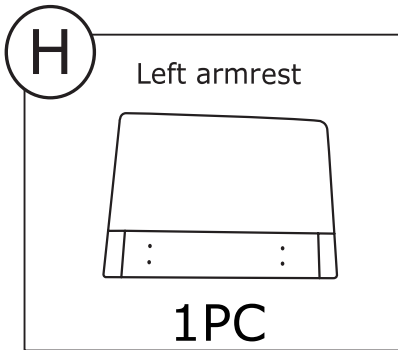



Note: Please retain all boxes until you are certain that your product isn't damaged and that you do not wish to return it. Disposal of boxes may prevent our ability to resolve your request.

ASSEMBLY STEPS

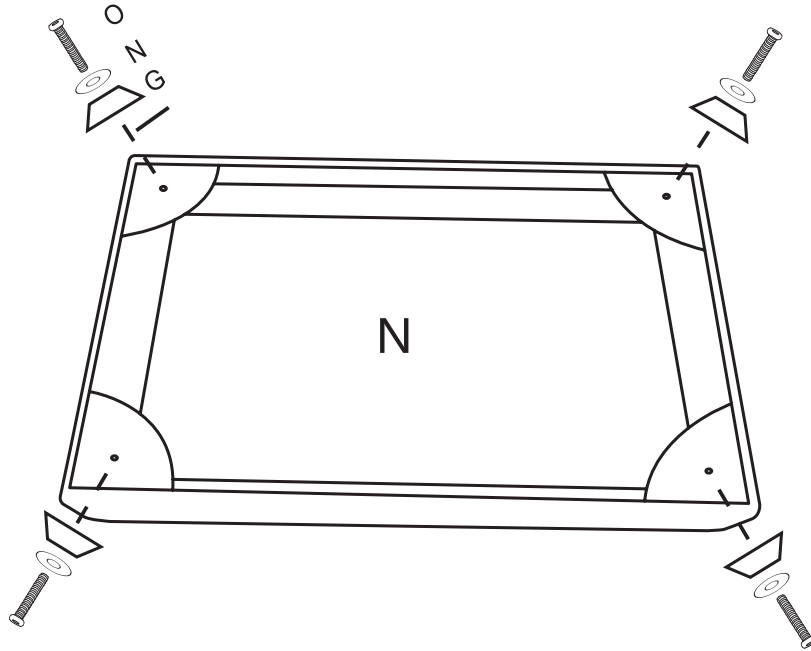
STEP 1: Assemble the Legs (G) on the ottoman frame with Gaskets (H) .



⊙ x 4	
⊙ x 4	
⊙ x 4	

STEP 2: The cushion is packaged by vacuum compression. After cutting the package, it rebounds quickly with in 4 hours. If the fabric has wrinkles, it will basically disappear after standing for 72 hours

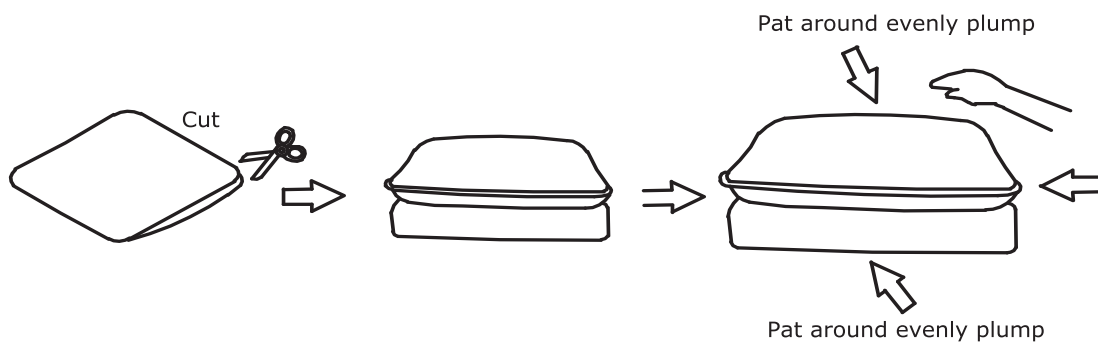

ASSEMBLY STEPS

STEP 1: Assemble the Left armrest (H) to the Seat frame (A) with Washers (N) and Bolts (O).

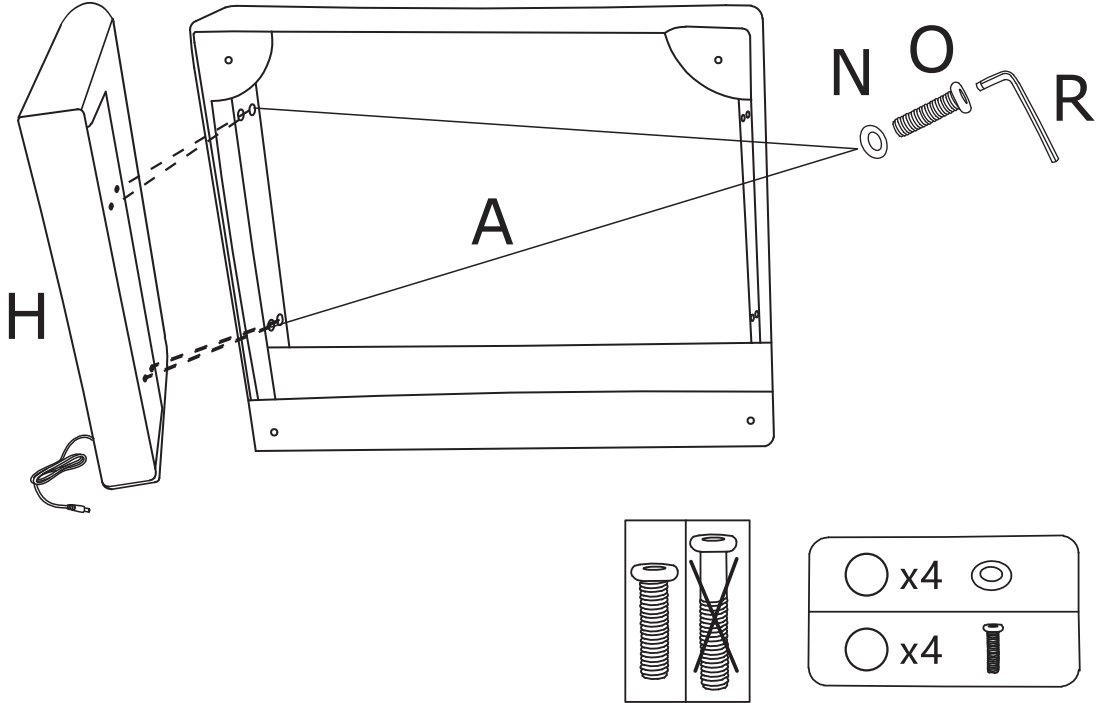

STEP 2: Assemble the Right armrest (I) to the Seat frame (A) with Washers (N) and Bolts (O).

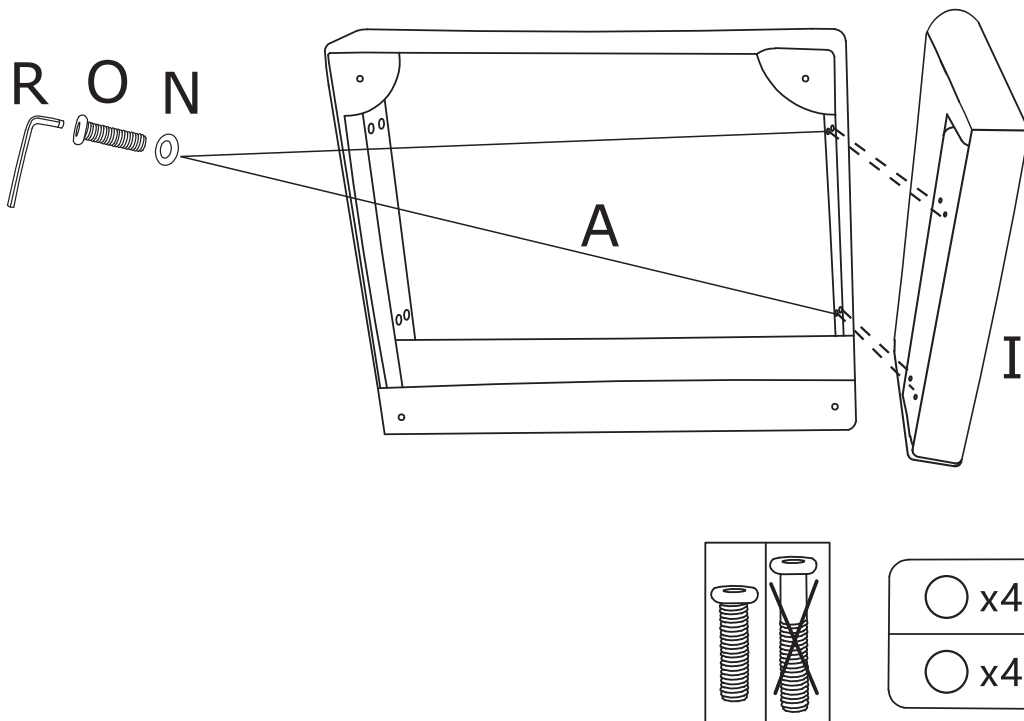

STEP 3: Assemble Seat frame (A) and Seat frame (A) with Butterfly nuts (Q) Washers (N) and Bolts (P).

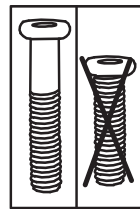
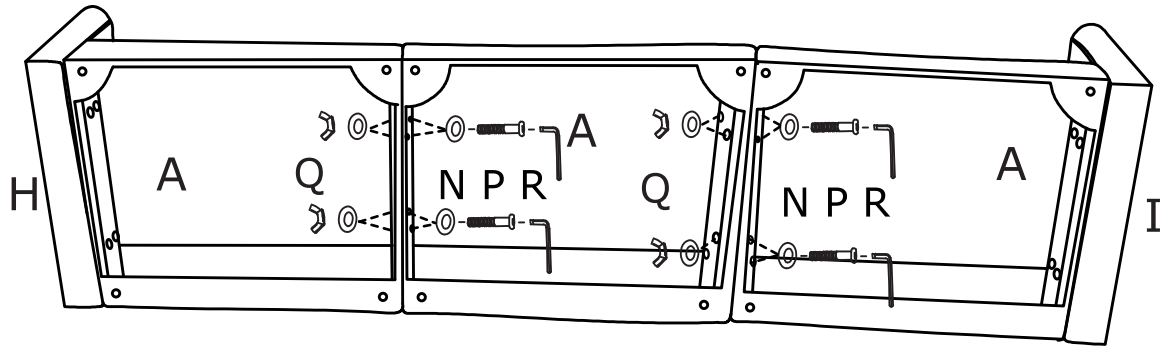

$\textcircled{N} \times 16$	\textcircled{O}
$\textcircled{P} \times 8$	\textcircled{I}
$\textcircled{Q} \times 8$	\textcircled{H}

STEP 4: Assemble the Legs (G) on the sofa with Gaskets (L).

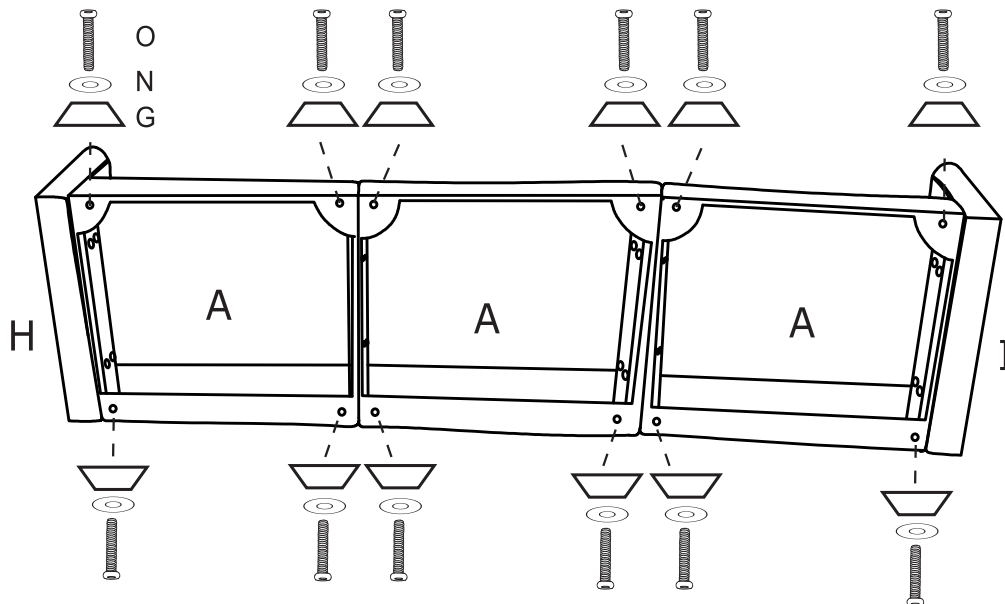

$\textcircled{G} \times 12$	\textcircled{L}
$\textcircled{N} \times 12$	\textcircled{O}
$\textcircled{O} \times 12$	\textcircled{I}

STEP 5: Insert the Backrest (F) into the designated holes, using Washer (N) and Bolts (O) to 70% tightness, and then tighten all Bolts on the seat.

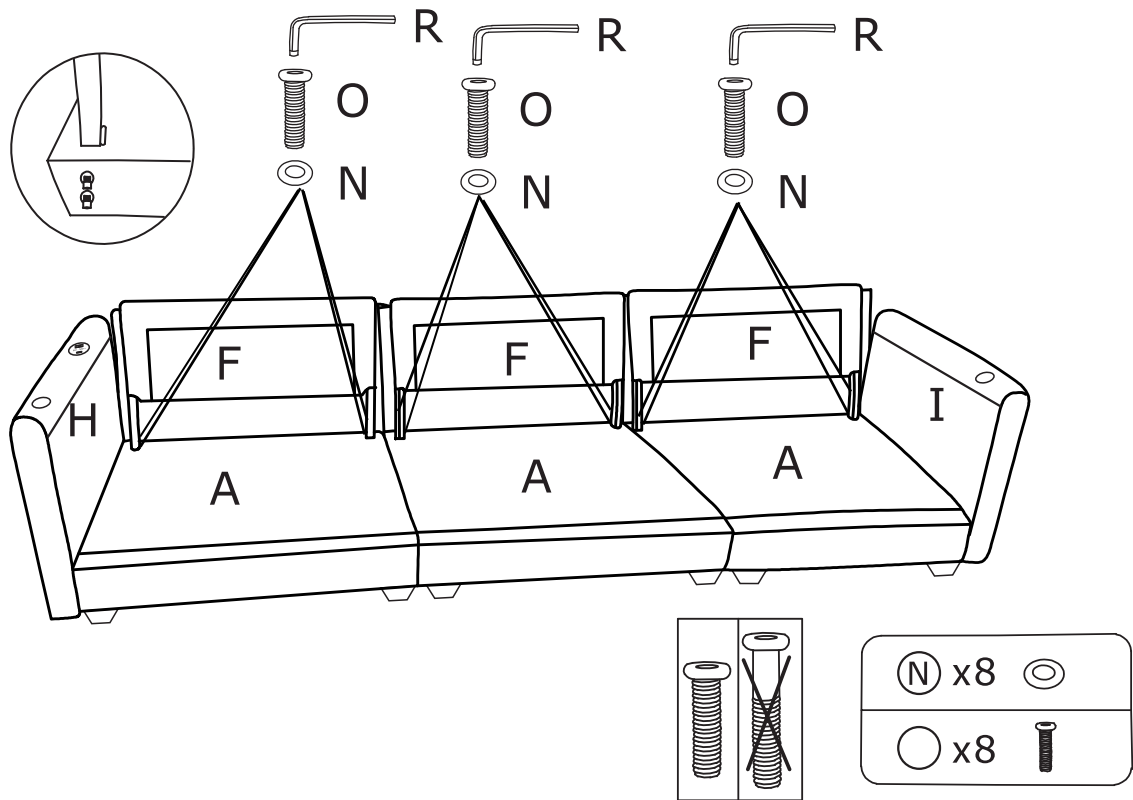

STEP 6: The cushion is packaged by vacuum compression. After cutting the package, it rebounds quickly within 4 hours. If the fabric has wrinkles, it will basically disappear after standing for 72 hours.

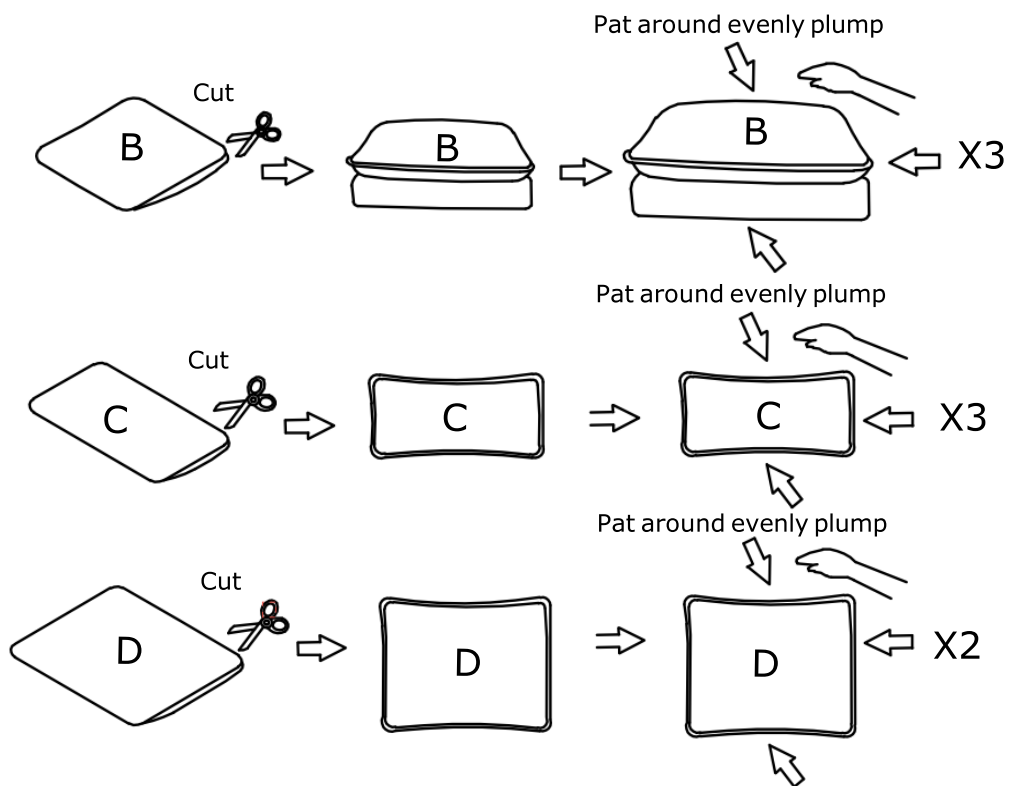

STEP 7: Place Seat cushions (B) and back cushions (C), and make sure it's will fitted.

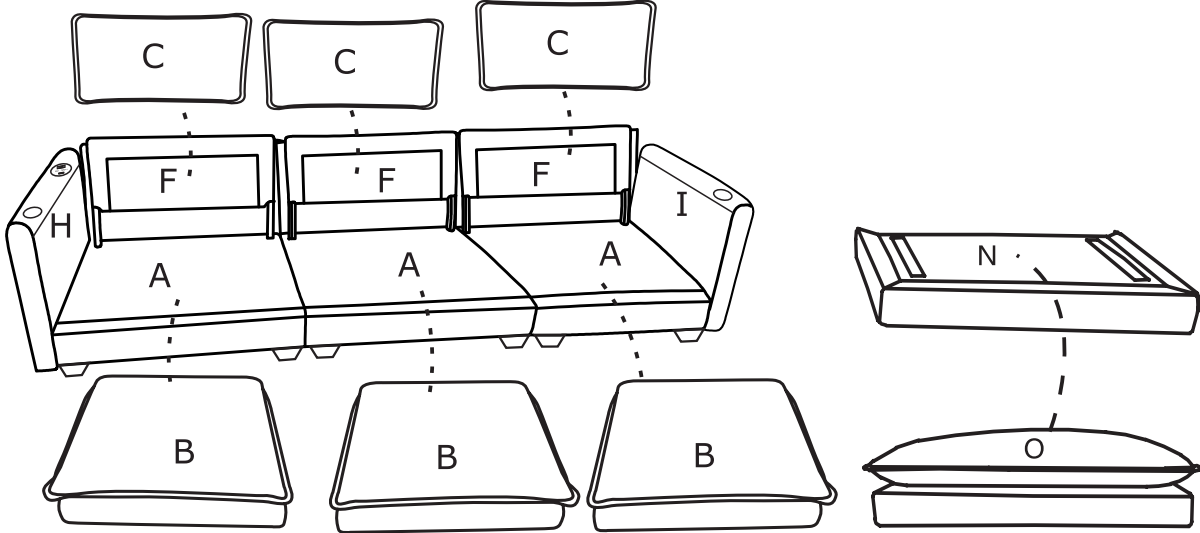

STEP 8: Place Pillows (E) and Pillows (D) on sofa and make sure it's will fitted.

