

5. MOUNTING AND WIRING

Step 1. Connect the wires from the fixture to the house supply wires with wire nuts (AA), ground wire (bare copper) to ground wire, neutral wire (white) to neutral wire, hot wire (black) to hot wire. Wrap the connection with electrical tape.

Step 2. Secure the Canopy on the Mounting Bracket (DD) with Canopy Screw (EE).

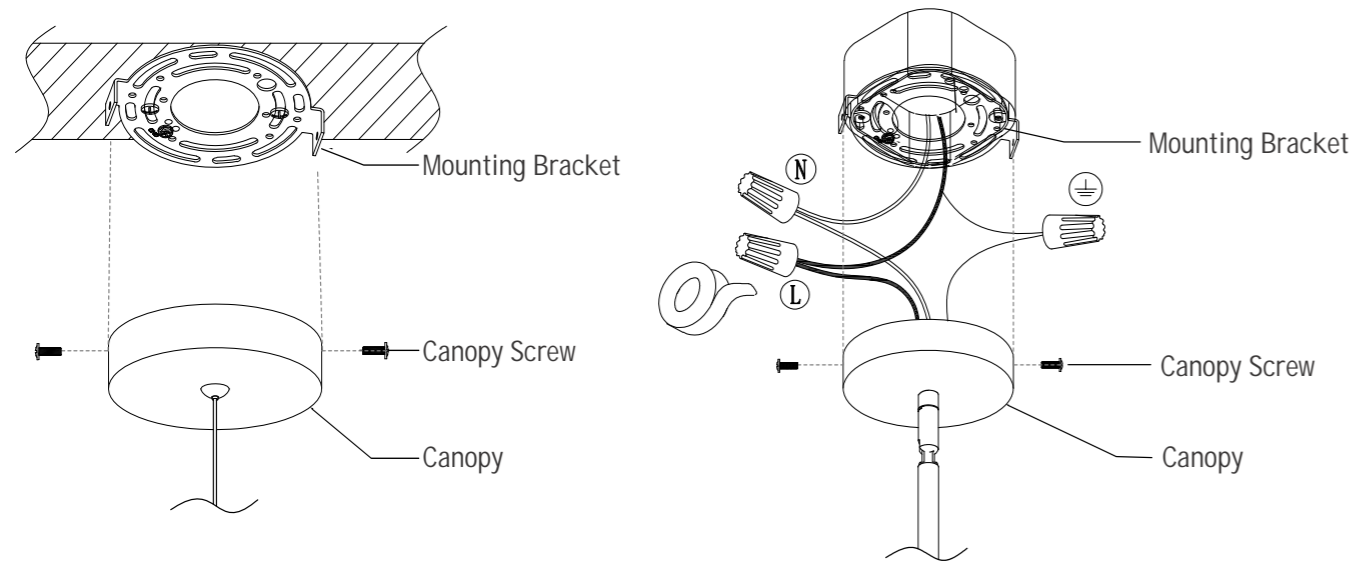

6. INSTALL BULBS AND LAMP SHADE

Step 1. Install 8 G9 LED bulbs (not included) up to 7W and a E26 bulb (not included) up to 60W, then install the Lamp Shade on the Socket.

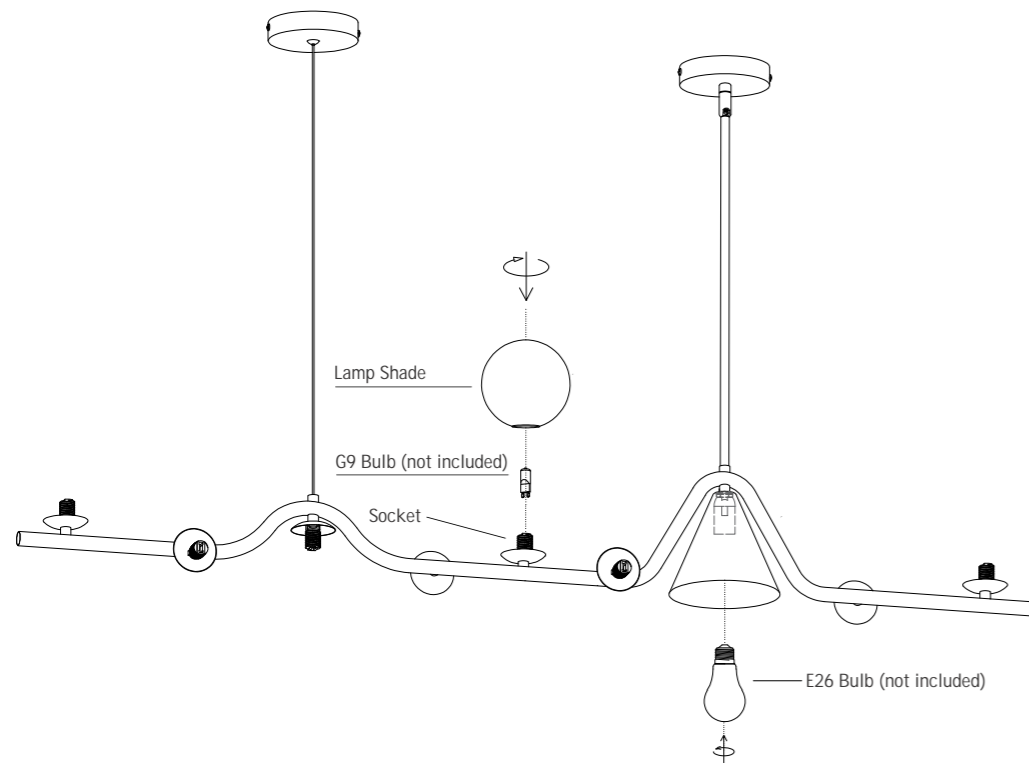

Note: Fully dimmable when used with dimmable bulbs and compatible dimming switches (not included).

INSTALLATION MANUAL

CHANDELIER

Model No.: HLP389BL+G-9A

TOOLS REQUIRED



Ladder

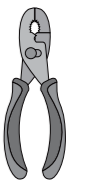

Pliers

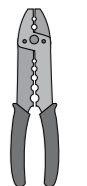

Wire Strippers

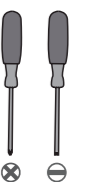



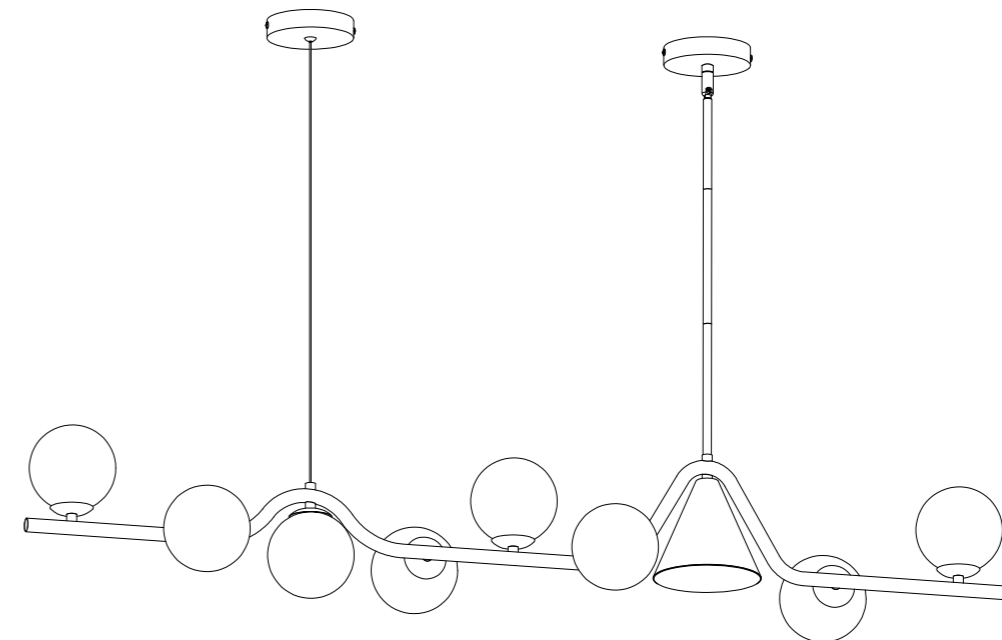

Screwdrivers

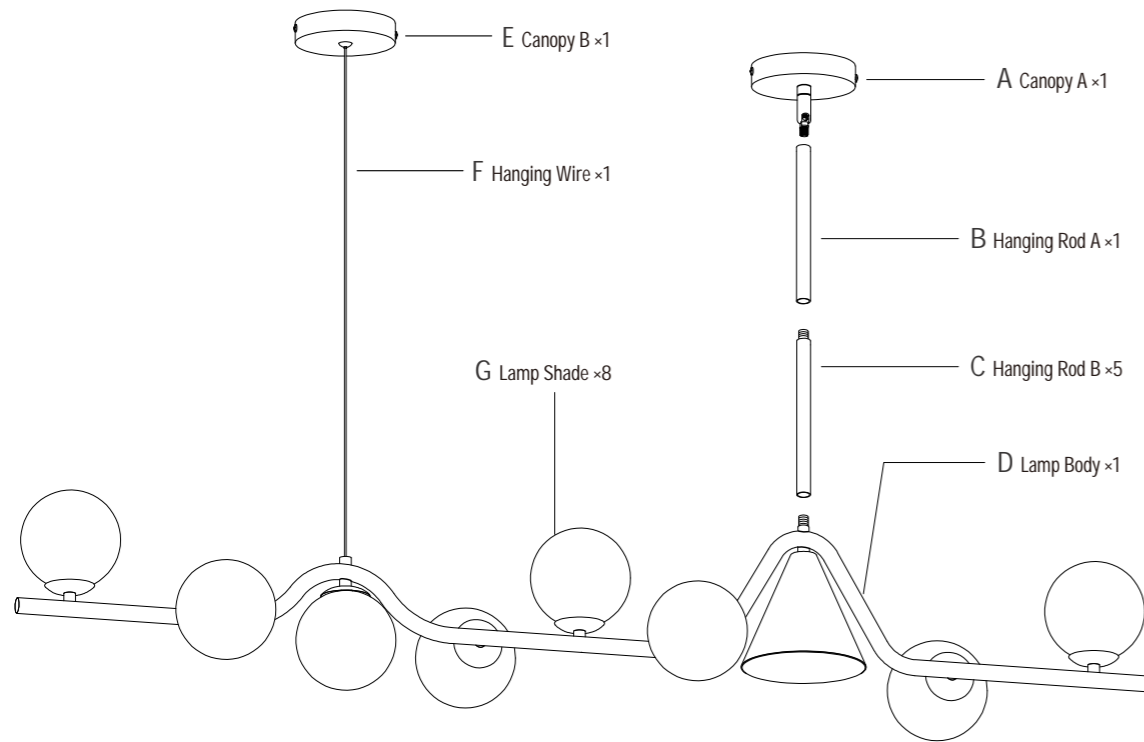

1.PACKING LIST

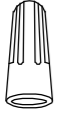

2.INSTALLATION KIT

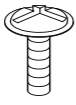
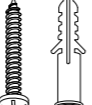
AA	 Wire Nut	3×	BB	 Outlet Box Screw	2×	CC	 Gloves	1×
DD	 Mounting Bracket	2×	EE	 Canopy Screw	4×	FF	 Wood Screw with Plastic Anchor	2×

Note:

1. Some extra hardware may be included. The quantity listed above is the number required for installation.
2. Parts "DD , EE" have already been pre-installed together with canopy.

3.FIXTURE ASSEMBLY

- Step 1. Fix the Hanging Rod with Nipples.
- Step 2. Pass the Main Wire through the Hanging Rod and Canopy (A).
- Step 3. Fix the two ends of the Hanging Rod on the Lamp body and Canopy (A).
- Step 4. Adjust the length of the Hanging Wire by pressing the Wire Locker to be the same as the Hanging Rod.

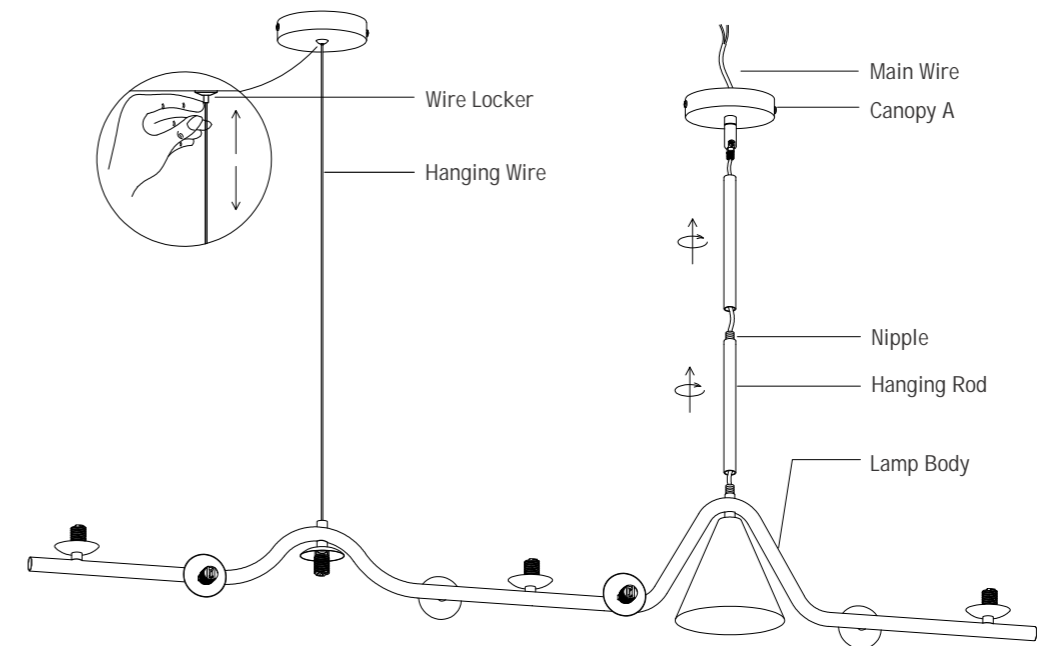

4. INSTALLING THE BRACKET

- Step 1. Loosen the Canopy Screw (EE) from Canopy, take out the Mounting Bracket (DD).
- Step 2. Take off the screws from Outlet box, secure the Mounting Bracket onto the box with screws taken off or Outlet Box Screw (BB) provided.
- Step 3. Secure the other Mounting Bracket on the Ceiling with Wood Screw with Plastic Anchor (FF) .
(Maintain a distance of 55cm/21.65inches between two brackets)

