

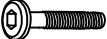

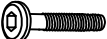



HARDWARE REQUIRED(BOX OF HEADBOARD)

- (A)  BOLT 1/4" x 1 3/16" - 6 PCS
- (B)  BOLT 1/4" x 1 9/16" - 2 PCS
- (C)  SPRING WASHER 1/4"- 8 PCS
- (D)  FLAT WASHER 1/4" - 8 PCS
- (E)  ALLEN KEY M4 - 1 PC
- (F)  ALLEN KEY M5 - 1 PC
- (G)  FLATHEAD CHIPBOARD SCREW 5/32" x 1 2/8"- 8 PCS
- (H)  WOOD DOWEL 5/16" x 1 3/16"- 2 PCS

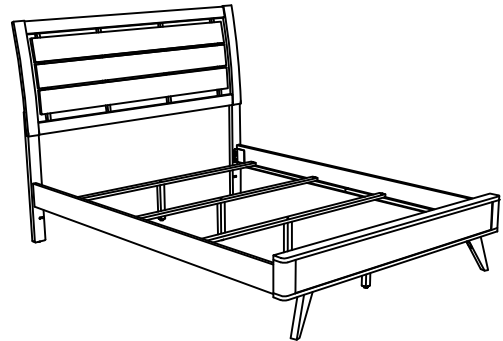

Attention:

*** Some number parts listed in the instruction sheet may not be in parts bags as they already be assembled. Caerfully check parts and packing materials prior to ordering replacements.

How to assemble:

