

# Assembly Instruction

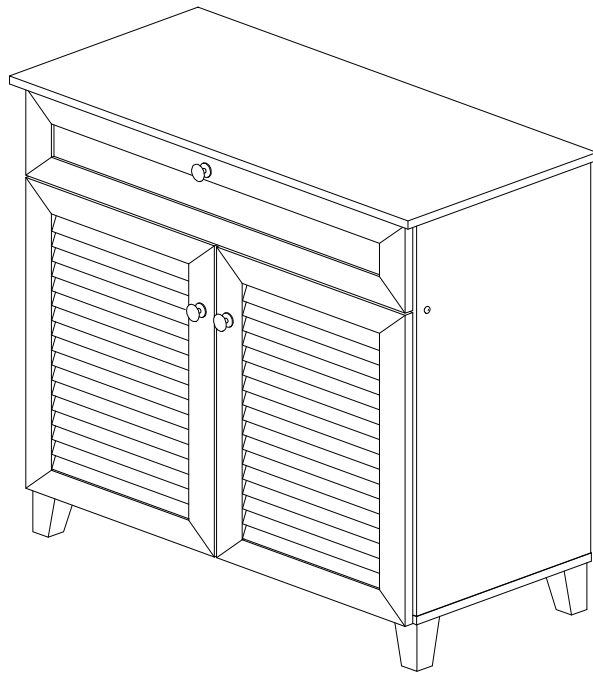

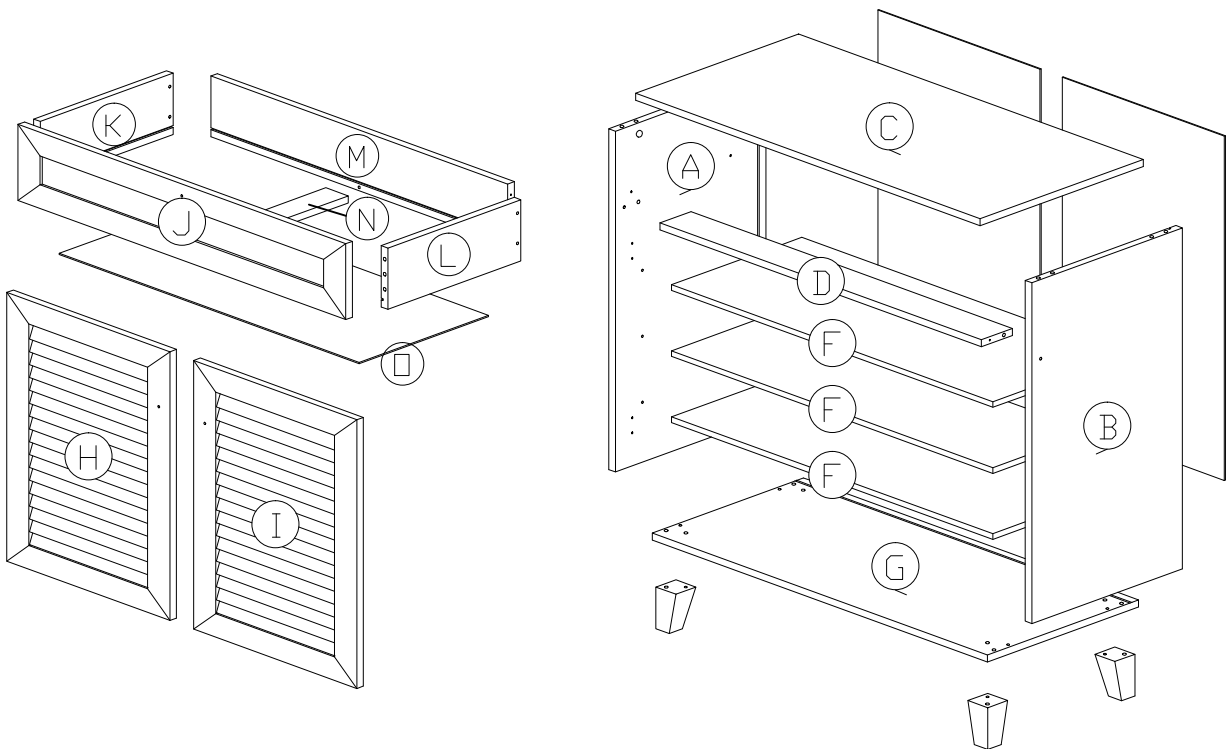





## Part List







# Assembly Instruction

## Hardware List

No.	SHAPE	DESCRIPTION	Qty.
1		<b>8x25mm Wood Dowel</b>	18Pcs
2		<b>15MM Titus Mini Fix</b>	7Sets
3		<b>M5x8mm Screw (Euro Screw)</b>	4Pcs
4		<b>TP 10#x1/2" Screw</b>	16Pcs
5		<b>M3.5x15mm Screw</b>	4Pcs
6		<b>M3x16mm Screw</b>	4Pcs
7		<b>M4x38mm Screw</b>	11Pcs
8		<b>M7x40mm Screw</b>	4Pcs
9		<b>Shelf Support</b>	12Pcs
10		<b>Handle (2293) M4x20mm (Handle Screw)</b>	3Sets
11		<b>Wooden Leg</b>	4Pcs

12		<b>L Key</b>	1Pc
13		<b>Z Bracket</b>	2Pcs
14		<b>Hinges (F012)</b>	4Sets
15		<b>Drawer Slide = 300mm</b>	1Set
16		<b>15mm Minifix Cap</b>	2Pcs
17		<b>Screw Cap</b>	2Pcs

## Packing Tipping Restraint

18		<b>M3.5x15mm Screw</b>	2Pcs
19		<b>Wall Plug</b>	2Pcs
20		<b>M4x30mm Screw</b>	2Pcs
21		<b>Safety Strap</b>	2Pcs
22		<b>Flat Washer 6x19x2mm</b>	4Pcs

## Step 1

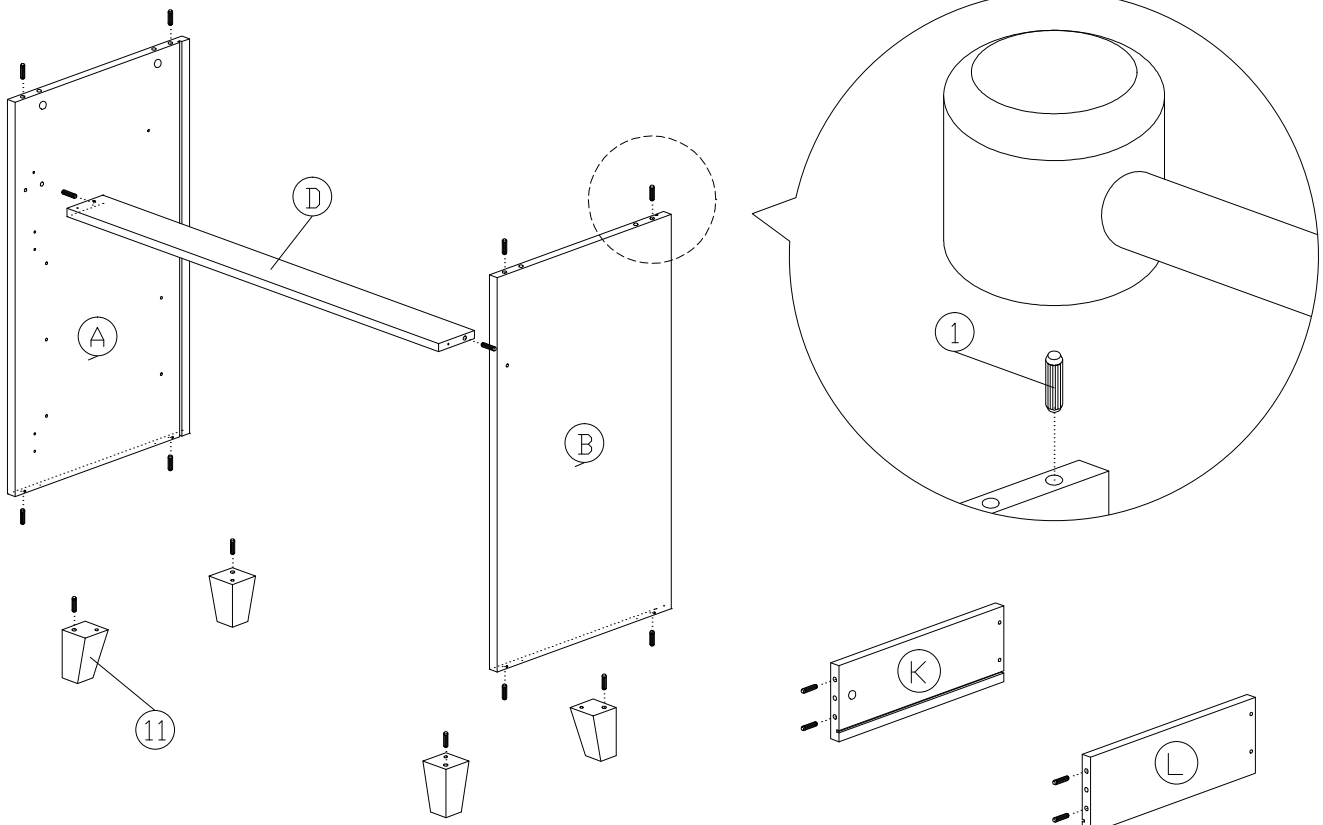

# Assembly Instruction

## Step 2

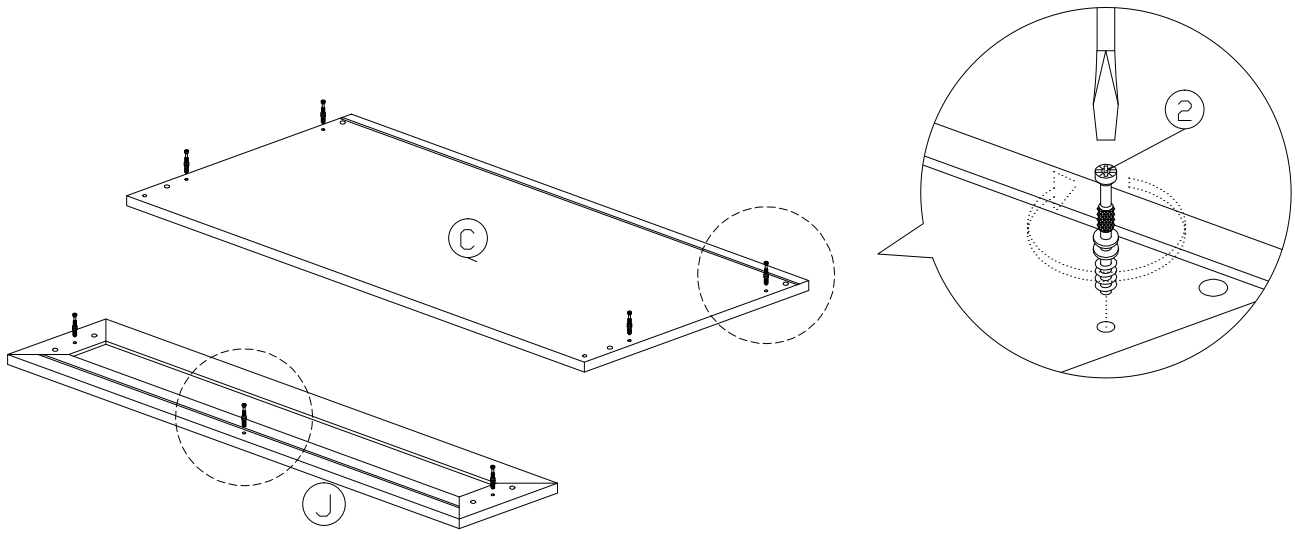

## Step 3

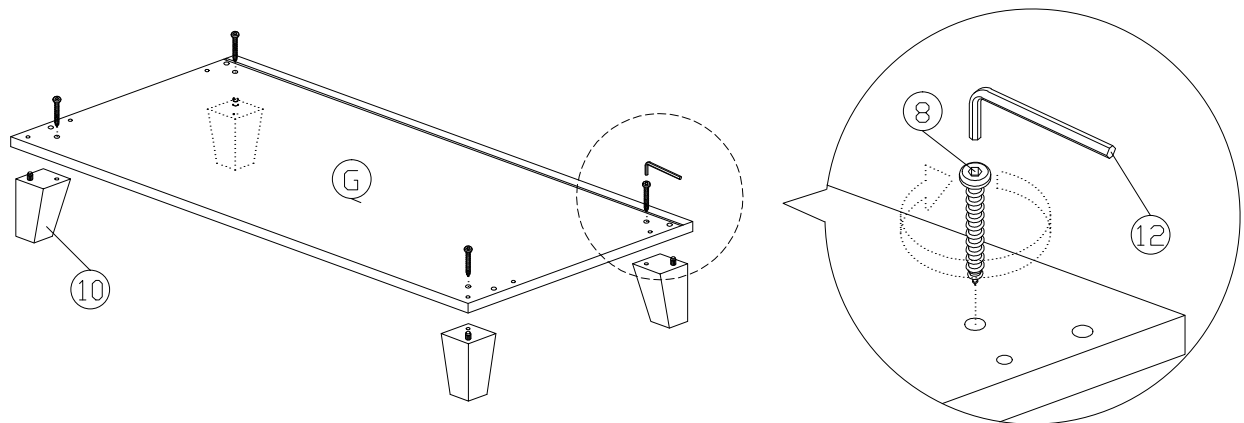

# Assembly Instruction

## Step 4

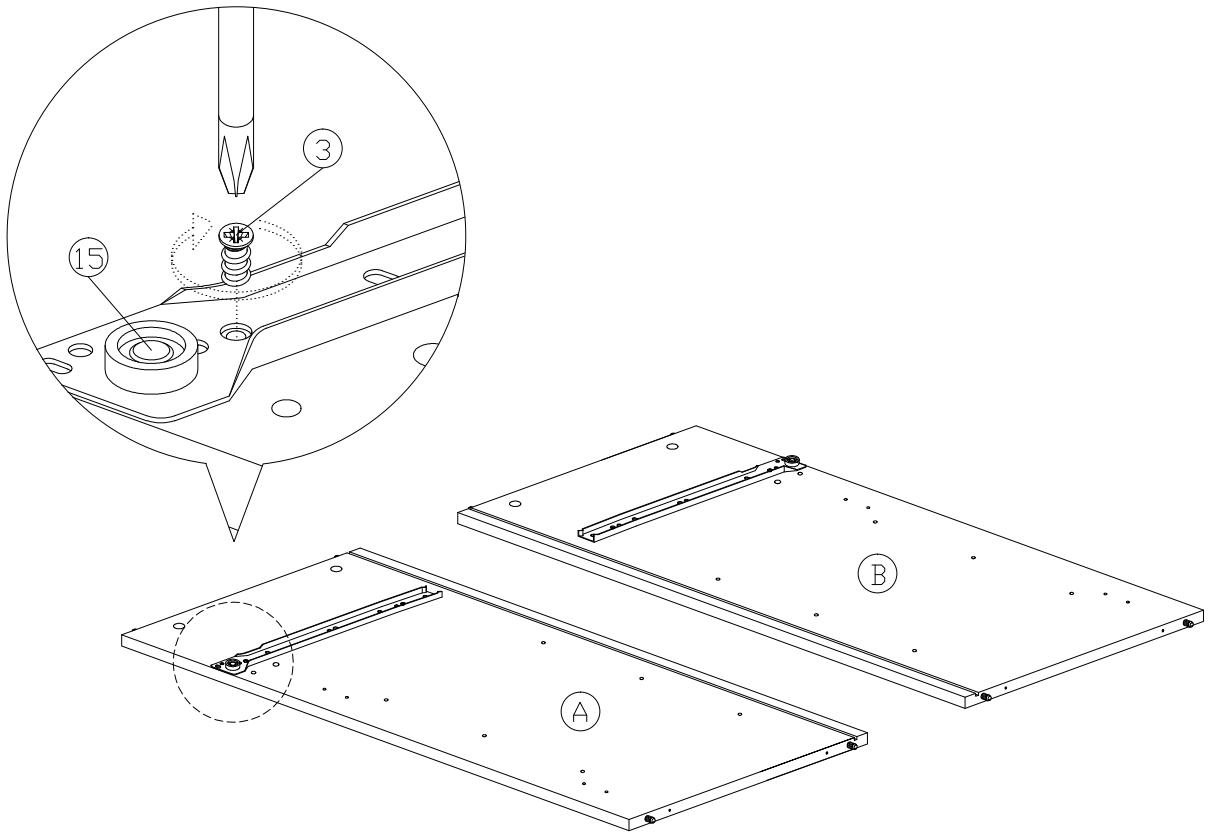

## Step 5

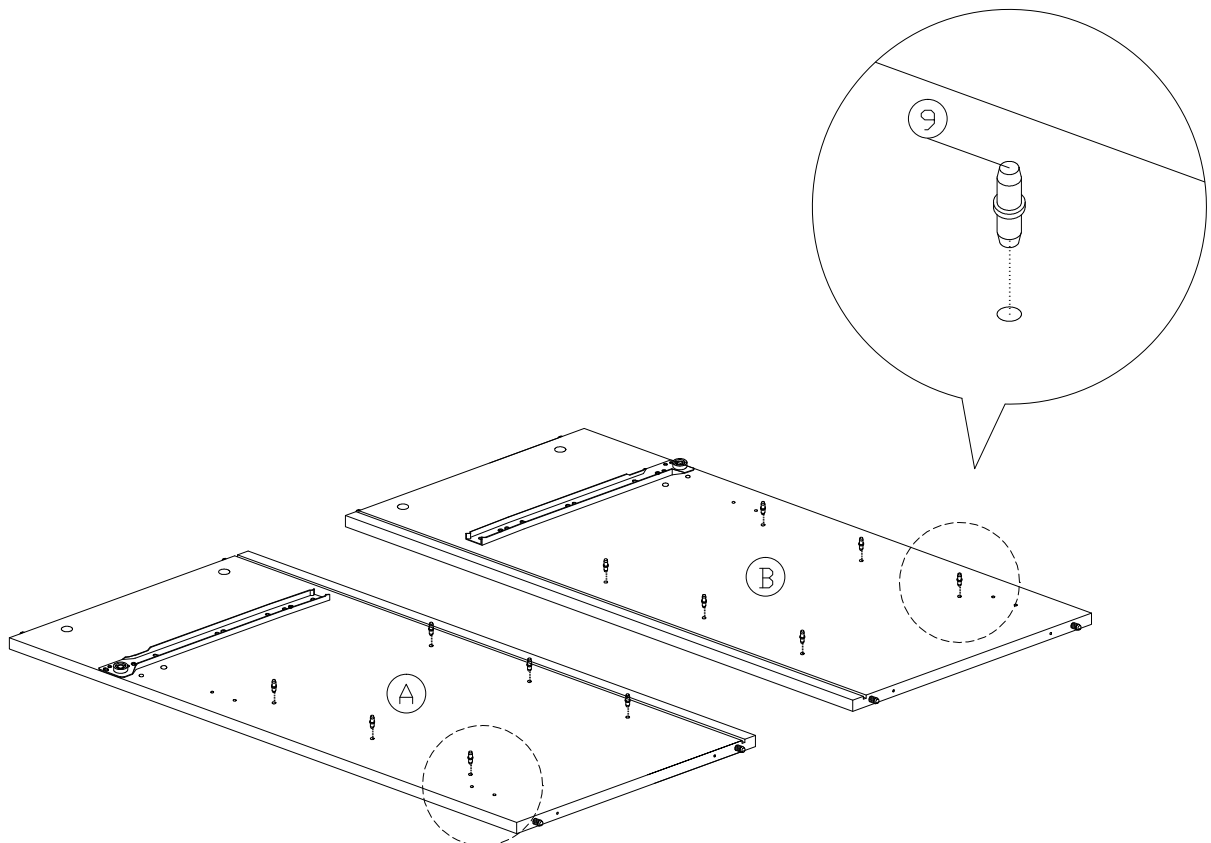

# Assembly Instruction

## Step 6

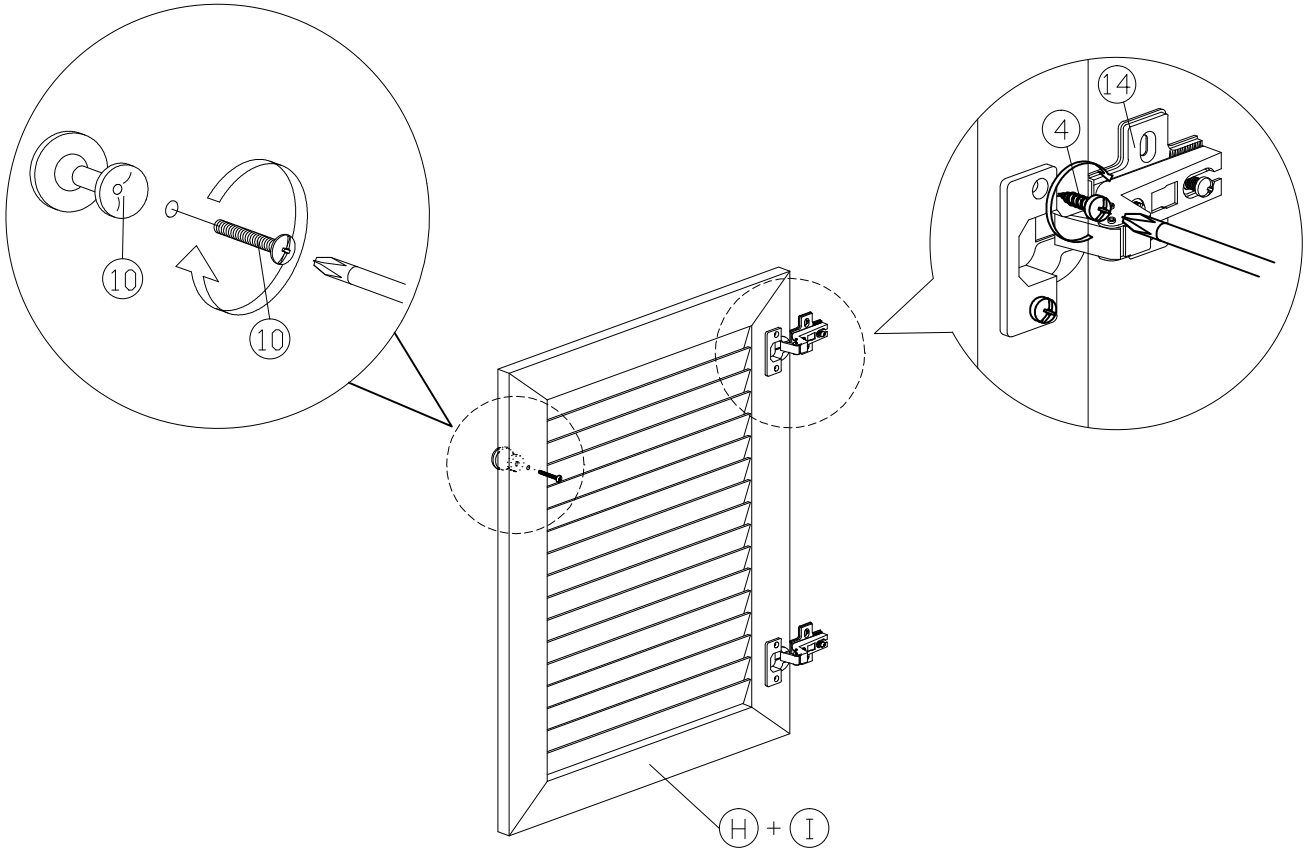

## Step 7

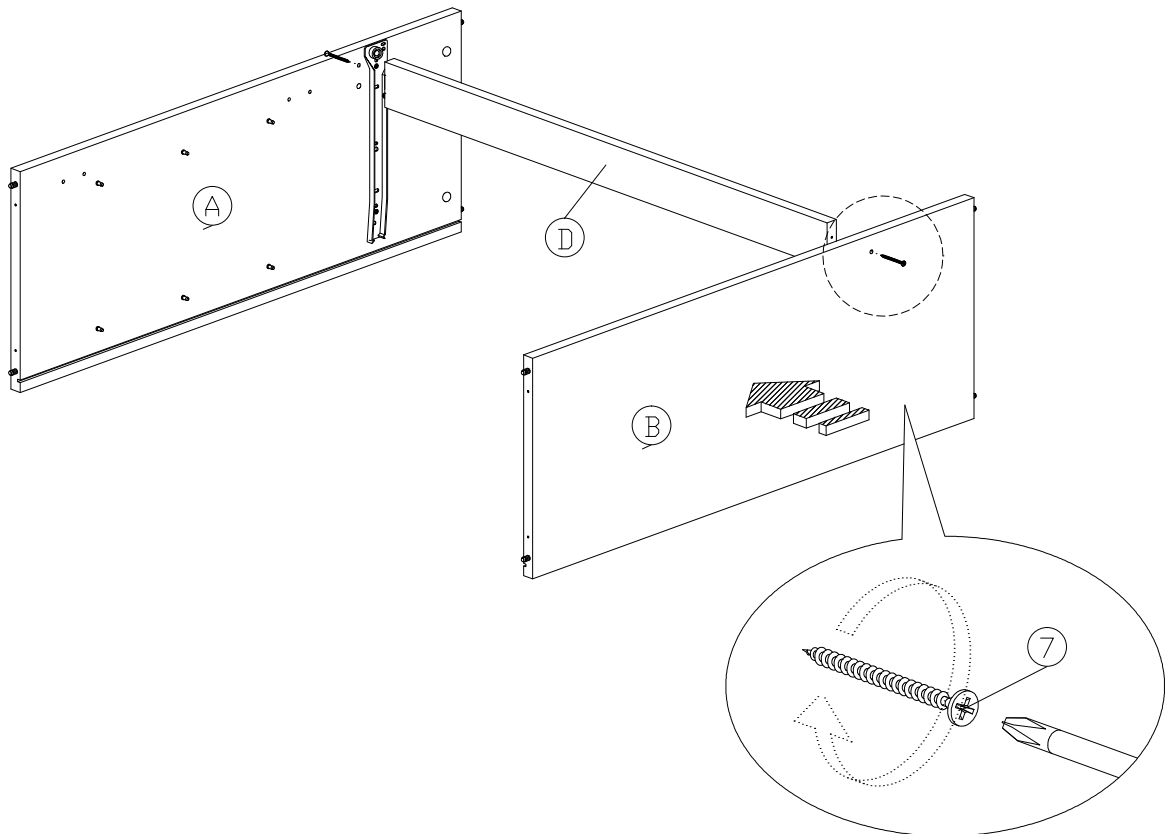

# Assembly Instruction

## Step 8

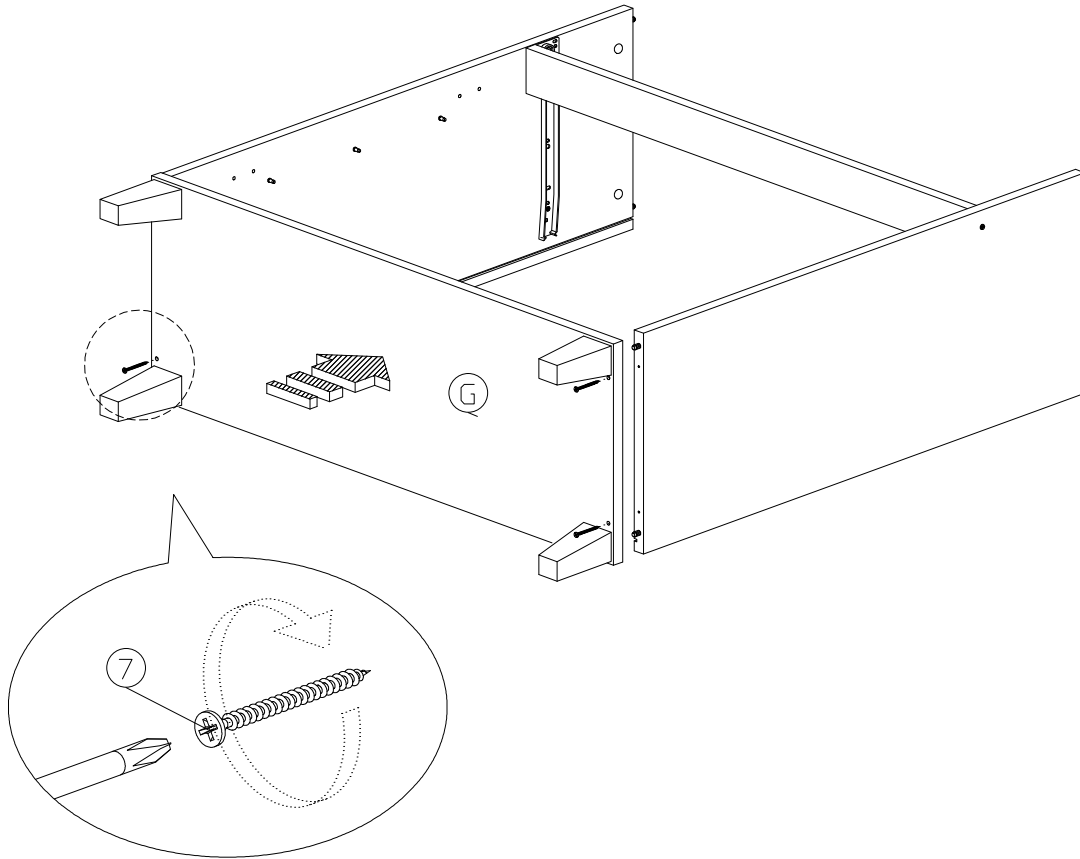

## Step 9

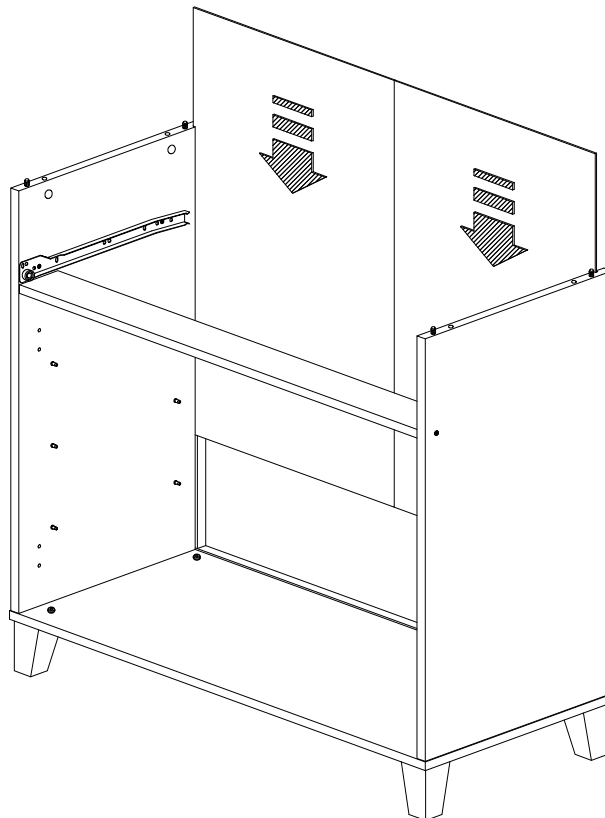

# Assembly Instruction

## Step 10

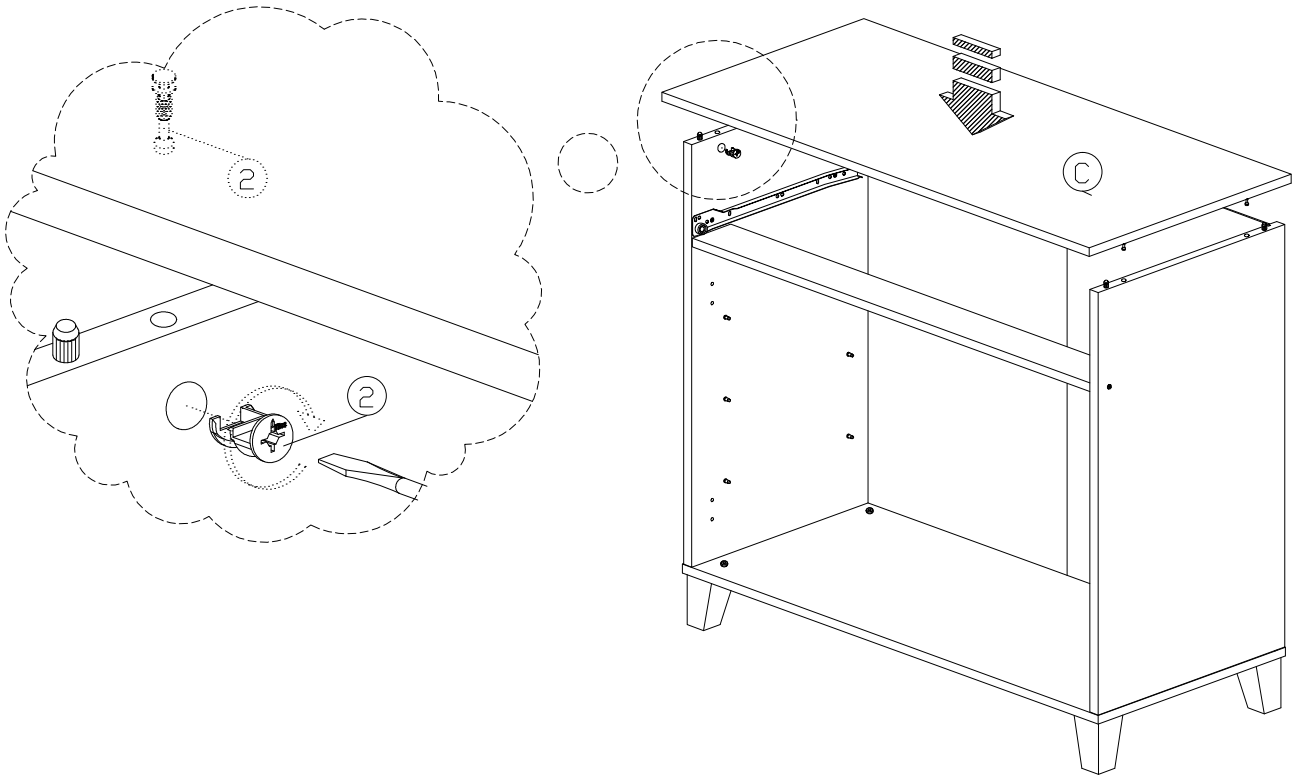

## Step 11

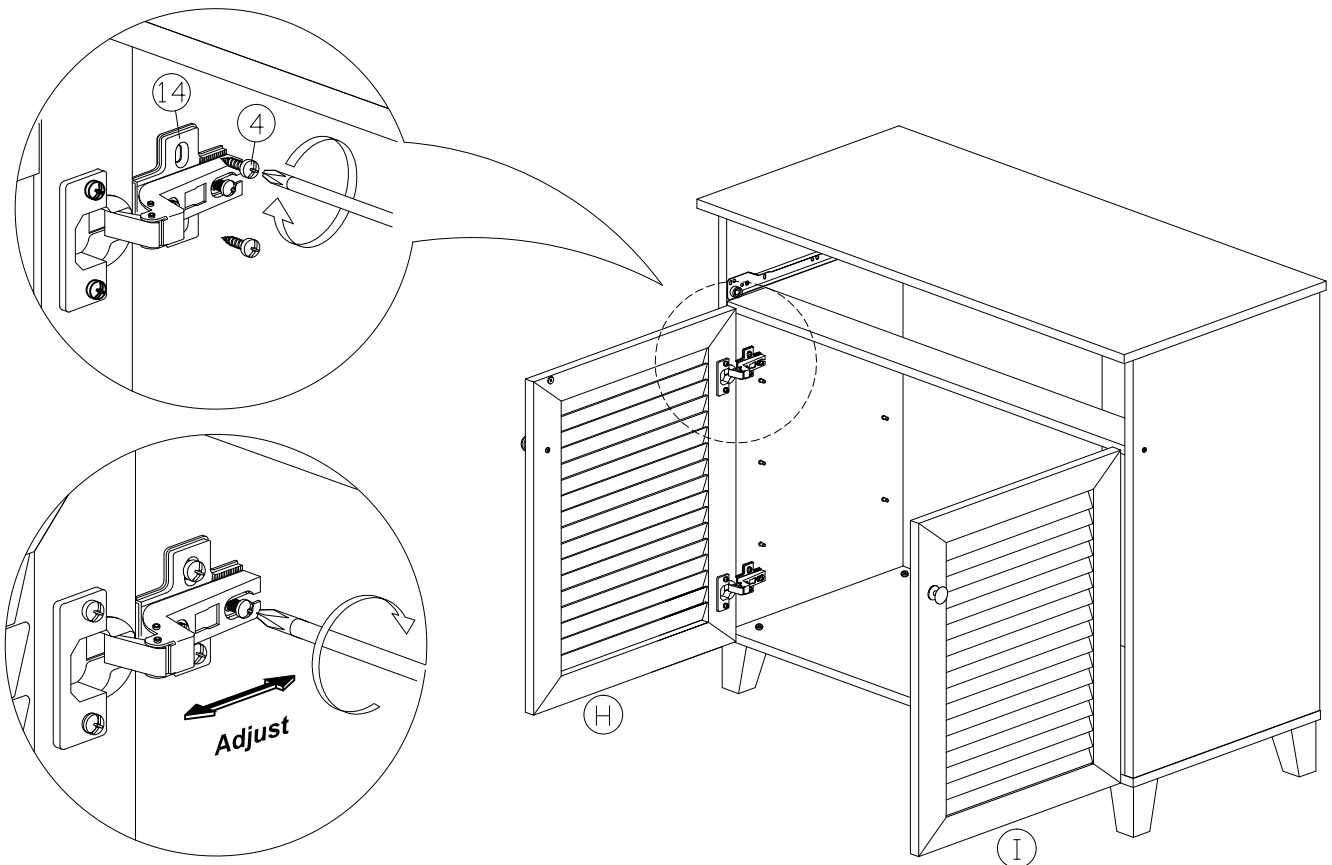

# Assembly Instruction

## Step 12

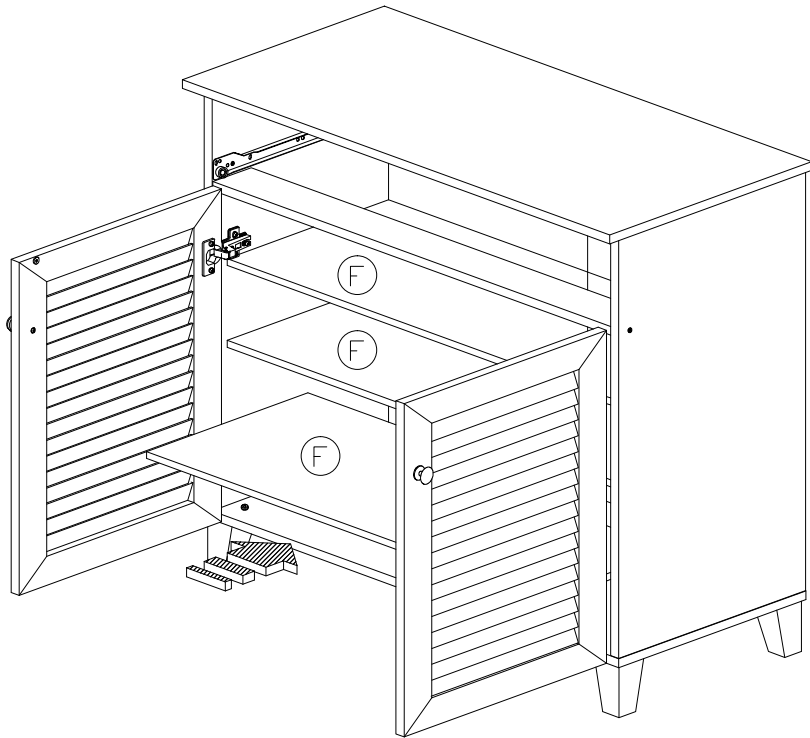

## Step 13

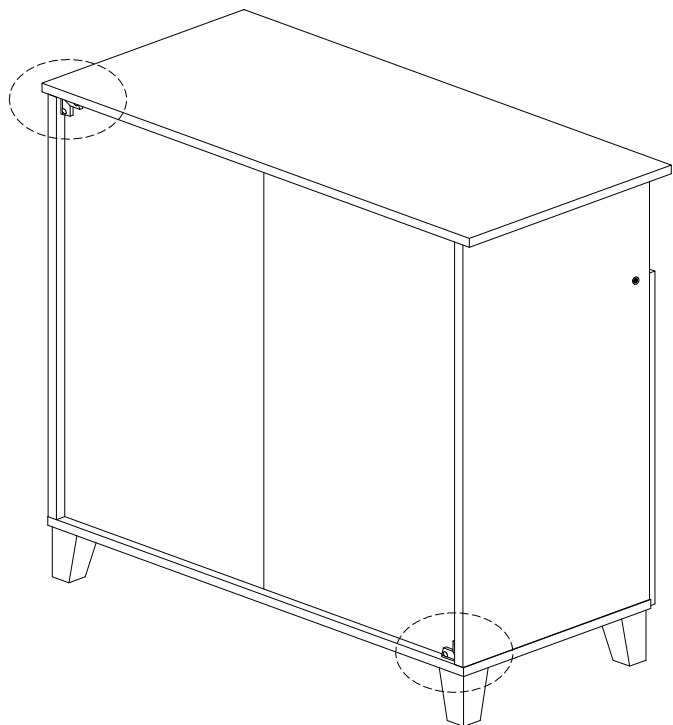
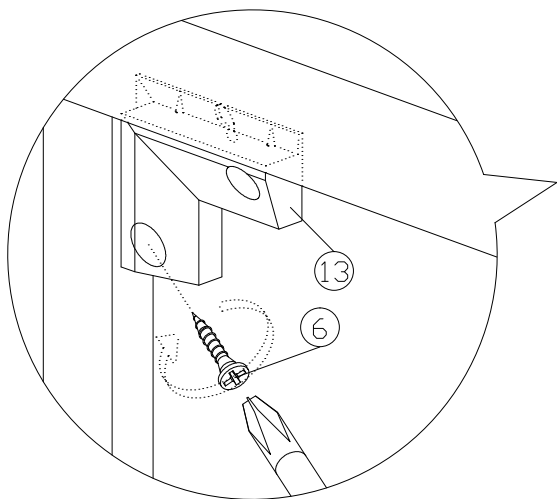

# Assembly Instruction

## Step 14

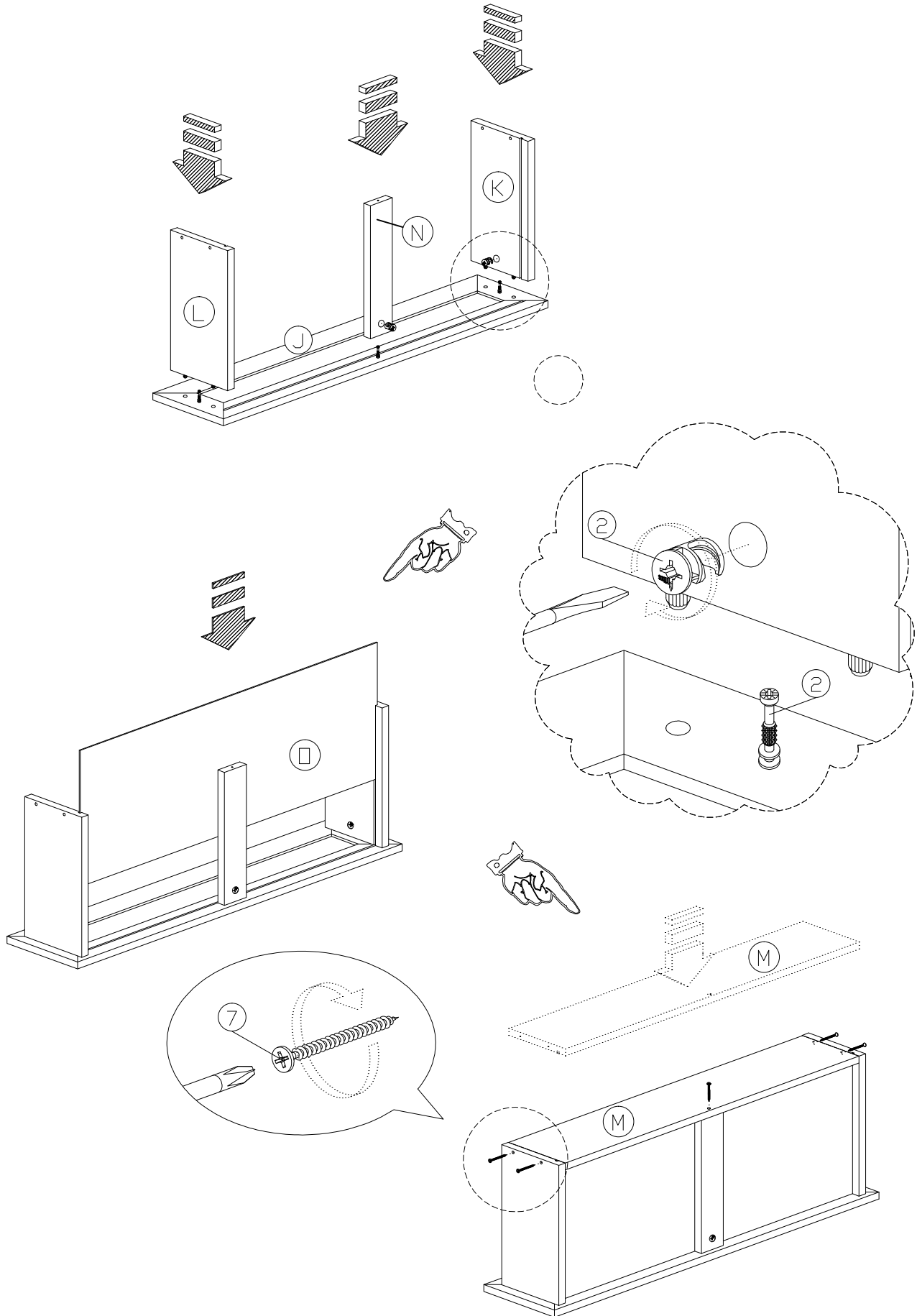

# Assembly Instruction

## Step 15

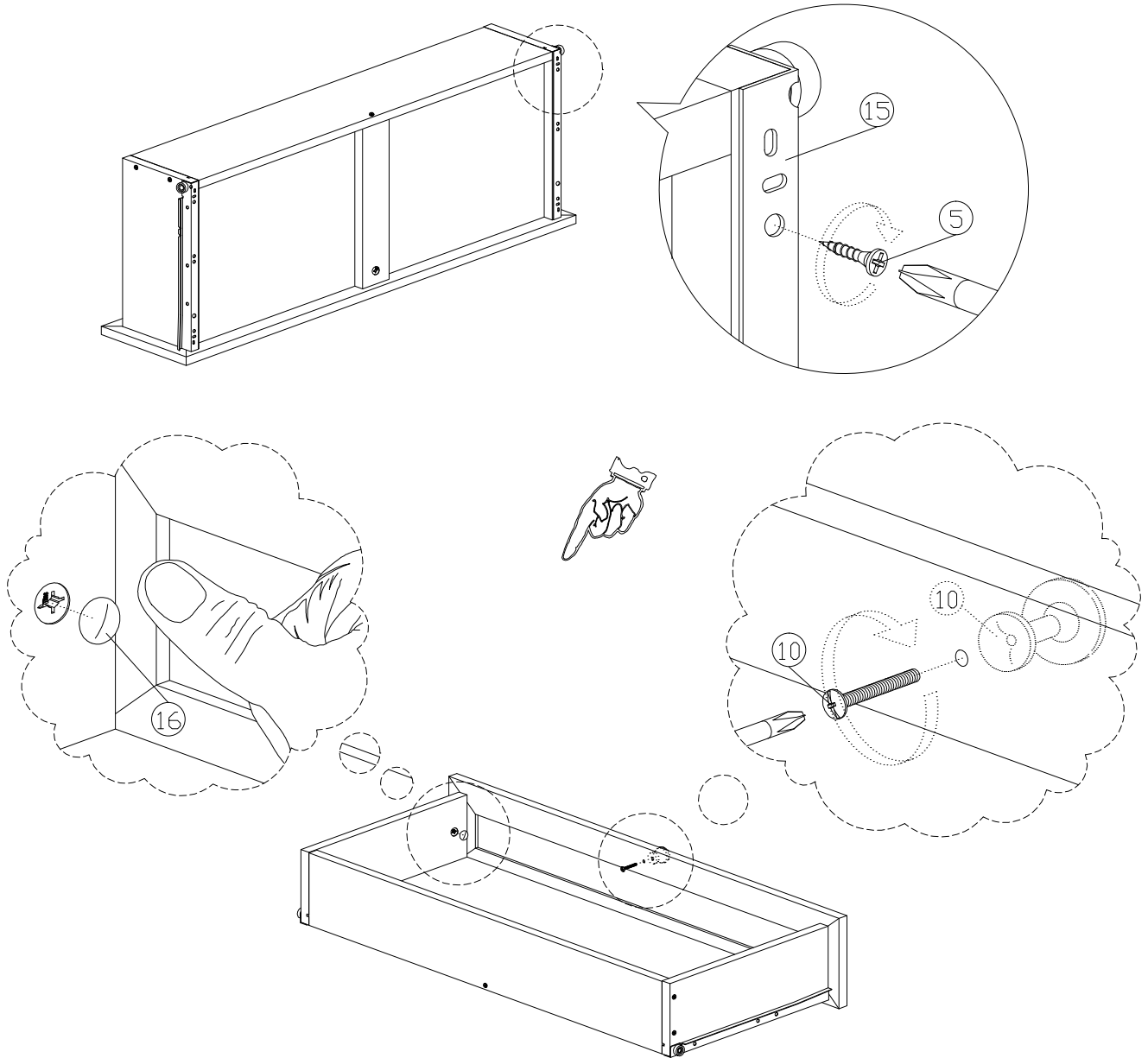

## Step 16

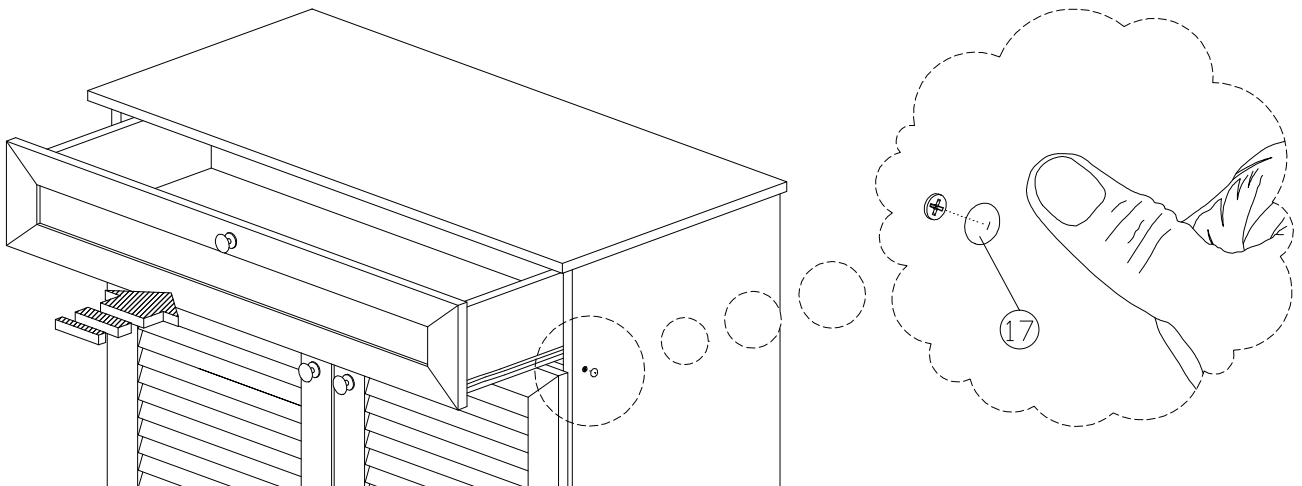

# FURNITURE TIPPING RESTRAINT

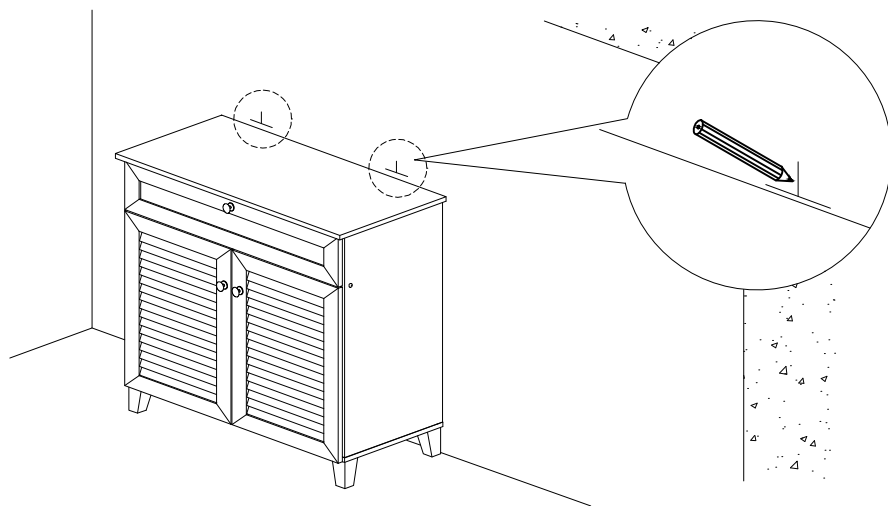

**1. First mark the wall with pencil as in diagram.**

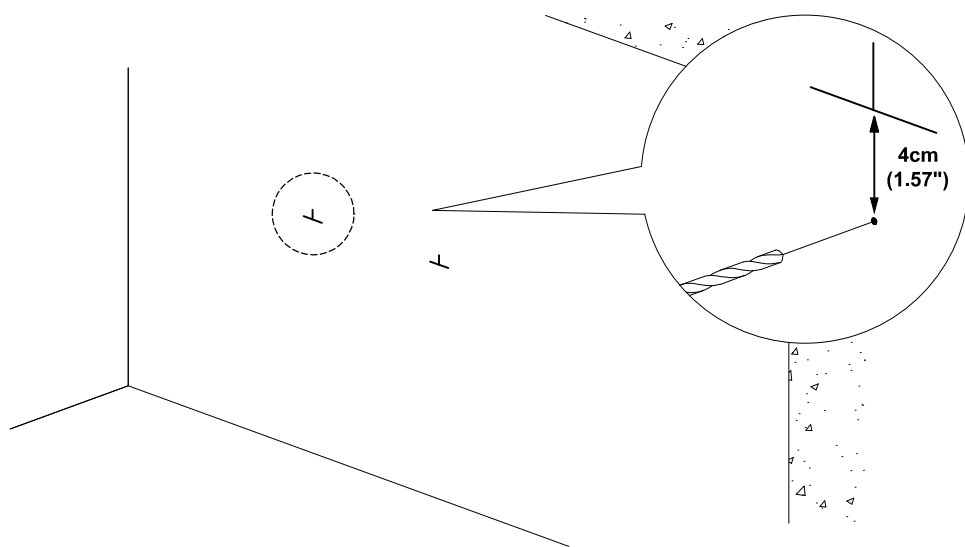

**2. Drill small hole at the pencil mark.**

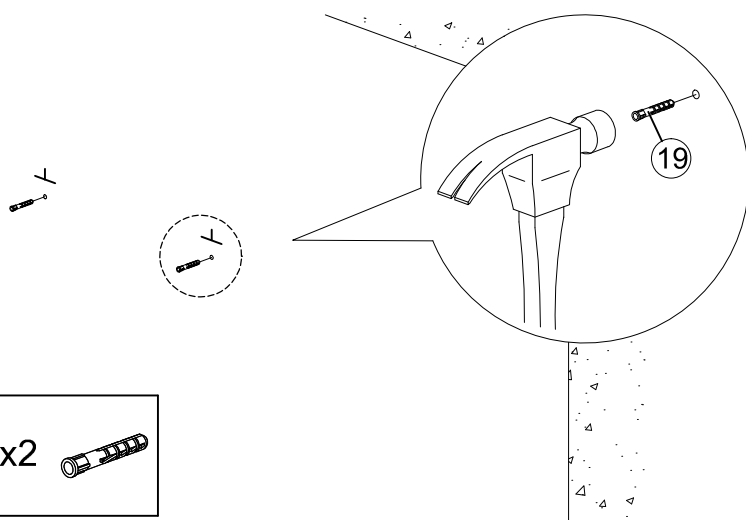

**3. Insert plastic wall plug (19).**

19 x2



## FURNITURE TIPPING RESTRAINT

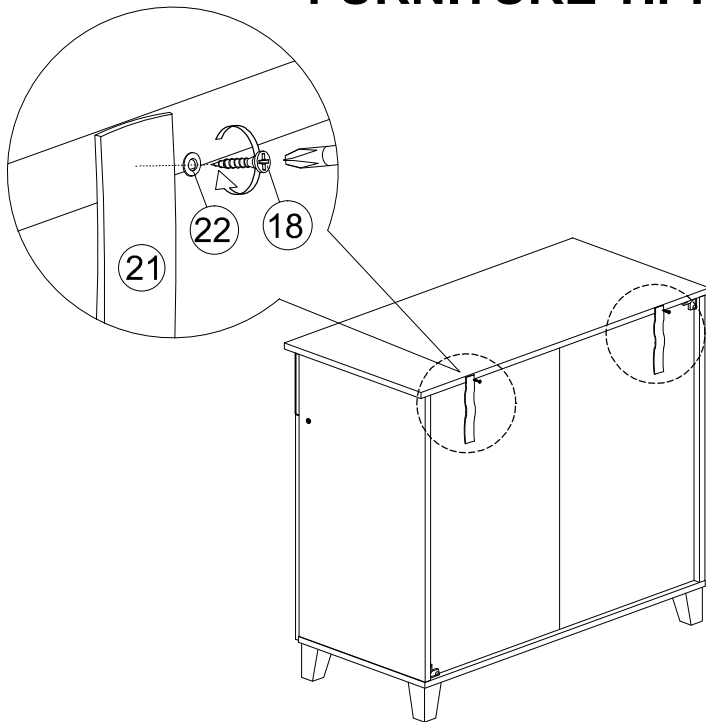

4. Add safety strap (21), washer (22) using 3.5x15mm screw (18) to back of cabinet.

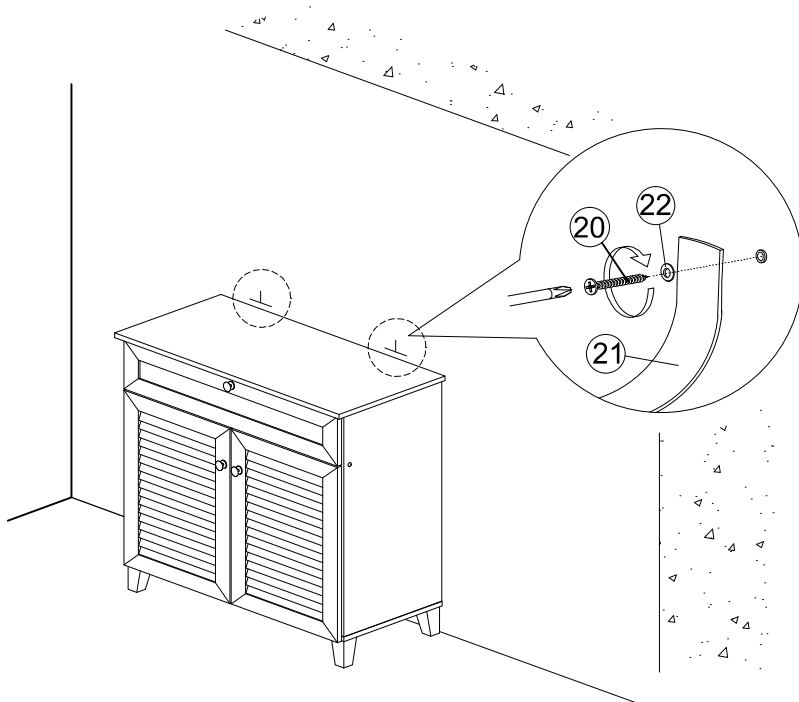
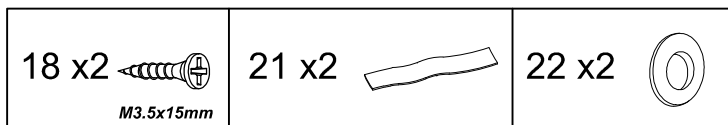

5. Finally, attach safety strap (21) and washer (22) using 4x30mm screw (20) to the wall.

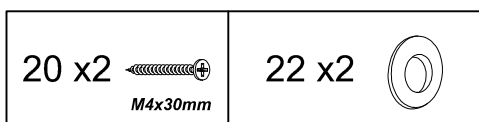

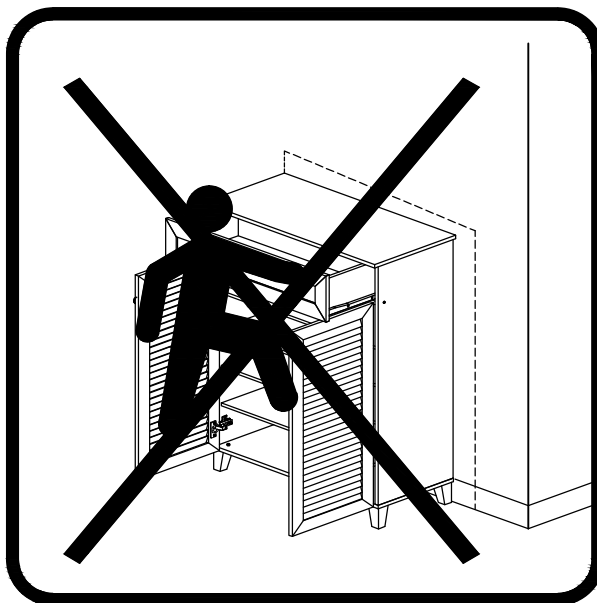
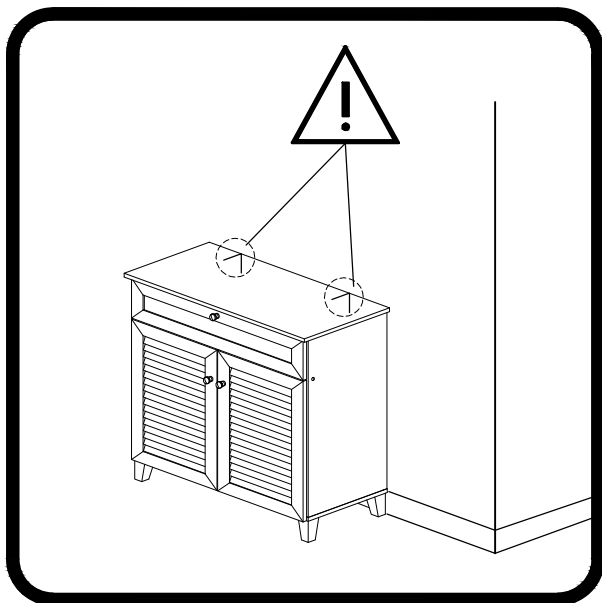

<b>⚠ WARNING</b>	
	<p>Children have died from furniture tipover. To reduce the risk of furniture tipover:</p> <ul style="list-style-type: none"><li>• ALWAYS install tipover restraint provided.</li><li>• NEVER put a TV on this product.</li><li>• NEVER allow children to stand, climb or hang on drawers, doors, or shelves.</li><li>• NEVER open more than one drawer at a time.</li><li>• Place heaviest items in the lowest drawers.</li></ul> <p><i>This is a permanent label. Do not remove!</i></p>
	



**Anti-Topple hardware included for added safety and stability**