

ASSEMBLY INSTRUCTION

Friendly Reminder:

- 1.This sofa is packed in 4 boxes. Please assemble it After all boxes are received.
- 2.As the cushions are all vacuum compressed,there will be some wrinkles. Please give your cushions up to 72 hours to reach its original size and the wrinkles will basically disappear.
- 3.Please do not open the compressed packages until your sofa frame is completely assembled.

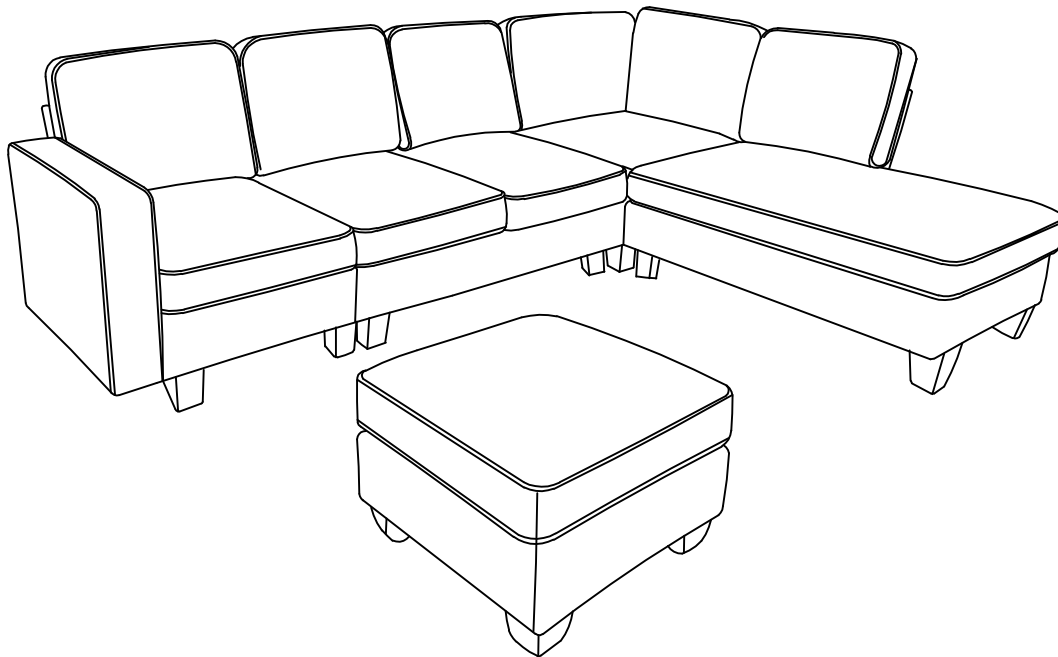







Return & Warranty policy:



- We strive to offer the highest quality products,and we also try our best to satisfy each and every customer that orders from us with replacement parts or service as needed.
- If the item is damaged or defective, please take photos as evidence for replacements and refunds.
- Please do not return to store,contact the seller if you have any troubles with this product.

ASSEMBLY INSTRUCTION

HARDWARE



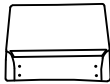

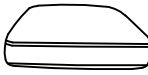
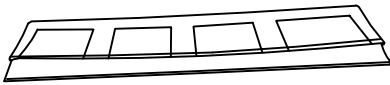

NO	DESCRIPTION	SKETCH	QTY
1	Washer		36
2	Screws 8X40		12
3	Screws 8X60		4
4	Screws 8X80		16
5	Butterfly nut		4
6	Wrench		1
7	Plastic gasket		20

PARTS LIST



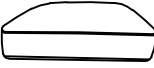

NO	DESCRIPTION	SKETCH	QTY
A	Seat frame		1
G	Back frame		2
L	Back cushion		2
H	Seat cushion		2
O	Back cover (long)		1

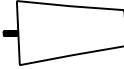
ASSEMBLY INSTRUCTION

PARTS LIST

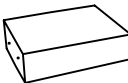

NO	DESCRIPTION	SKETCH	QTY
B	Corner wood frame		1
C	Ottoman frame		1
K	Ottoman cushion		1
I	Corner seat cushion		1
M	Corner back cushion (left)		1
N	Corner back cushion (right)		1
Q	Leg		20

PARTS LIST

NO	DESCRIPTION	SKETCH	QTY
D	Seat frame (left)		1
H	Seat cushion		1
F	Armrest (left)		1
L	Back cushion		1

ASSEMBLY INSTRUCTION

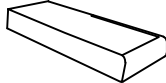
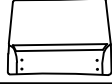
PARTS LIST

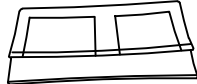
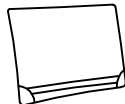
NO	DESCRIPTION	SKETCH	QTY
E	Seat frame (right)		1
G	Back frame		2
L	Back cushion		1
J	Seat cushion		1
P	Back cover (short)		1
R	Corner back frame		2

All parts and hardwares.

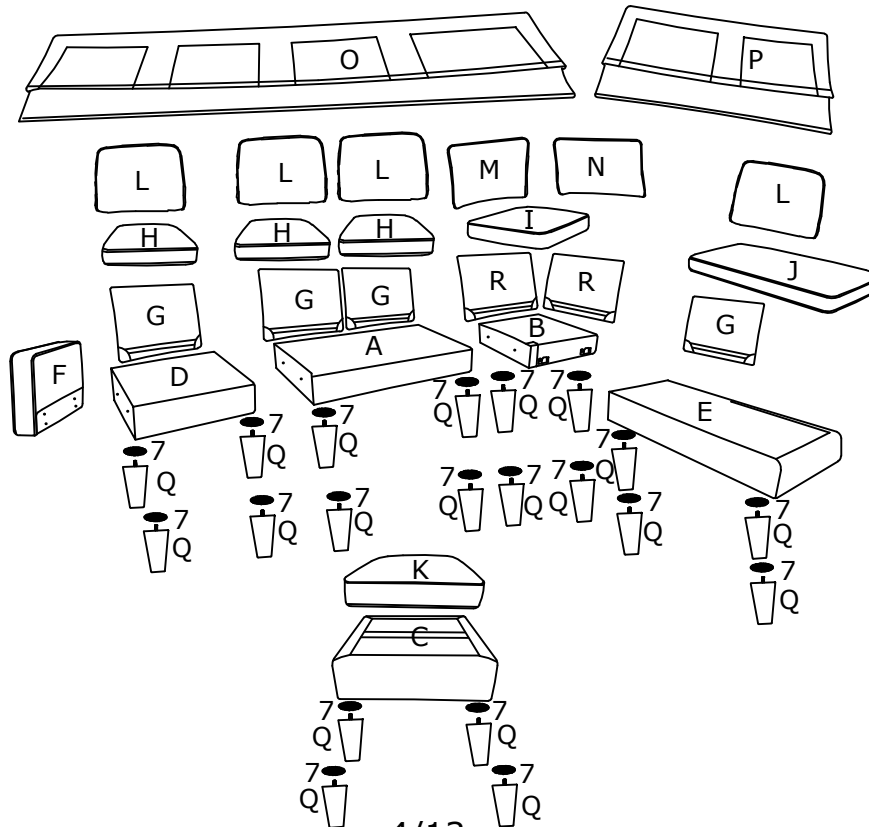

DIAGRAM 1 (Take out all parts)

Take the Back frame (Parts G) Back cushion (Parts L) Seat cushion (Parts H) Back cover (long) (Parts O) out of the Seat frame (Parts A).

Take the Ottoman frame (Parts C) Ottoman cushion (Parts K) Corner seat cushion (Parts I) Corner back cushion (left) (Parts M) Corner back cushion (right) (Parts N) Leg (Parts Q) out of the Corner wood frame(Parts B).

Take the Seat cushion(Parts H) Armrest (left) (Parts F) Back cushion (Parts L) out of the Seat frame (left) (Parts D).

Take the Back frame (Parts G) Back cushion (Parts L) Seat cushion (Parts J)Back cover (short) (Parts P) Corner back frame (Parts R) out of the Seat frame (right)(Parts E).

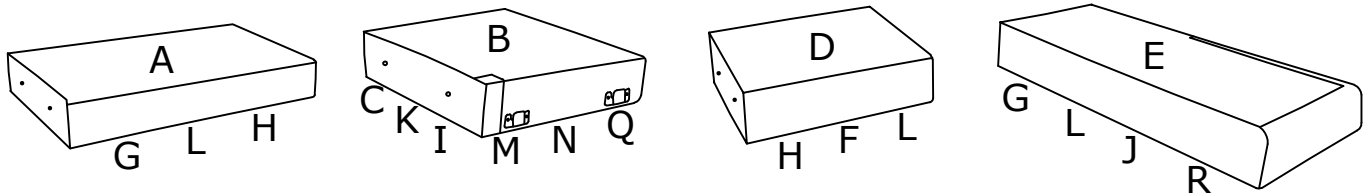



DIAGRAM 2 (Assemble the Armrest (left) to the Seat frame)

Connect the Armrest(left) (Parts F) with the Screws M8X60 (Hardware 3)and the Washer (Hardware 1)by Wrench(Hardware 6).

1		4PCS
3	 M8X60	4PCS

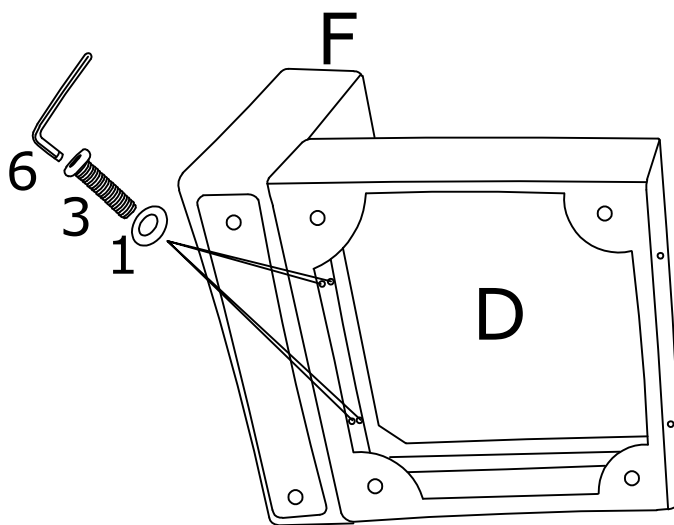

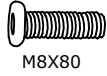



DIAGRAM 3 (Assemble the Seat frame (left),
Seat frame and Corner wood frame)

Connect the Seat frame (left)(Parts D) and Seat frame (Parts A) with the Corner wood frame(Parts B) the Screws M8X80 (Hardware 4) with the Butterfly nuts(Hardware 5) and the Washer (Hardware 1) by Wrench (Hardware 6).

1		8PCS
4	 M8X80	4PCS
5		4PCS

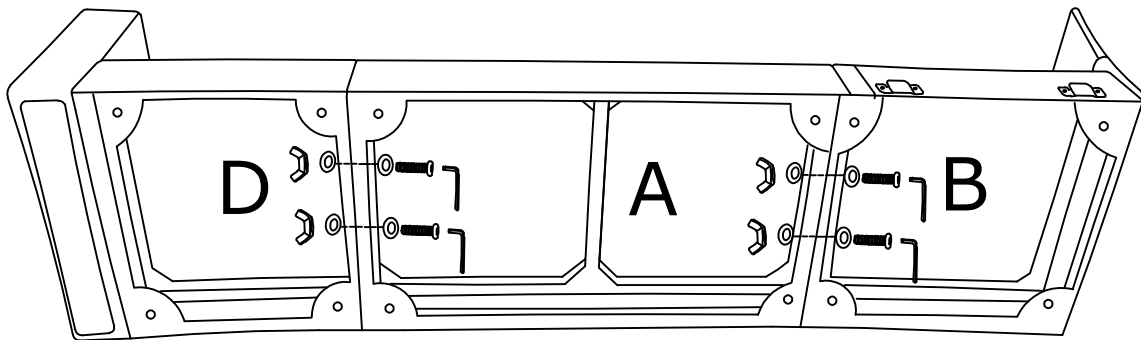



DIAGRAM 4 (Assemble the Legs)

Tighten 12 Legs (Parts Q) by Plastic gasket(Hardware 7).

7		12PCS
Q		12PCS

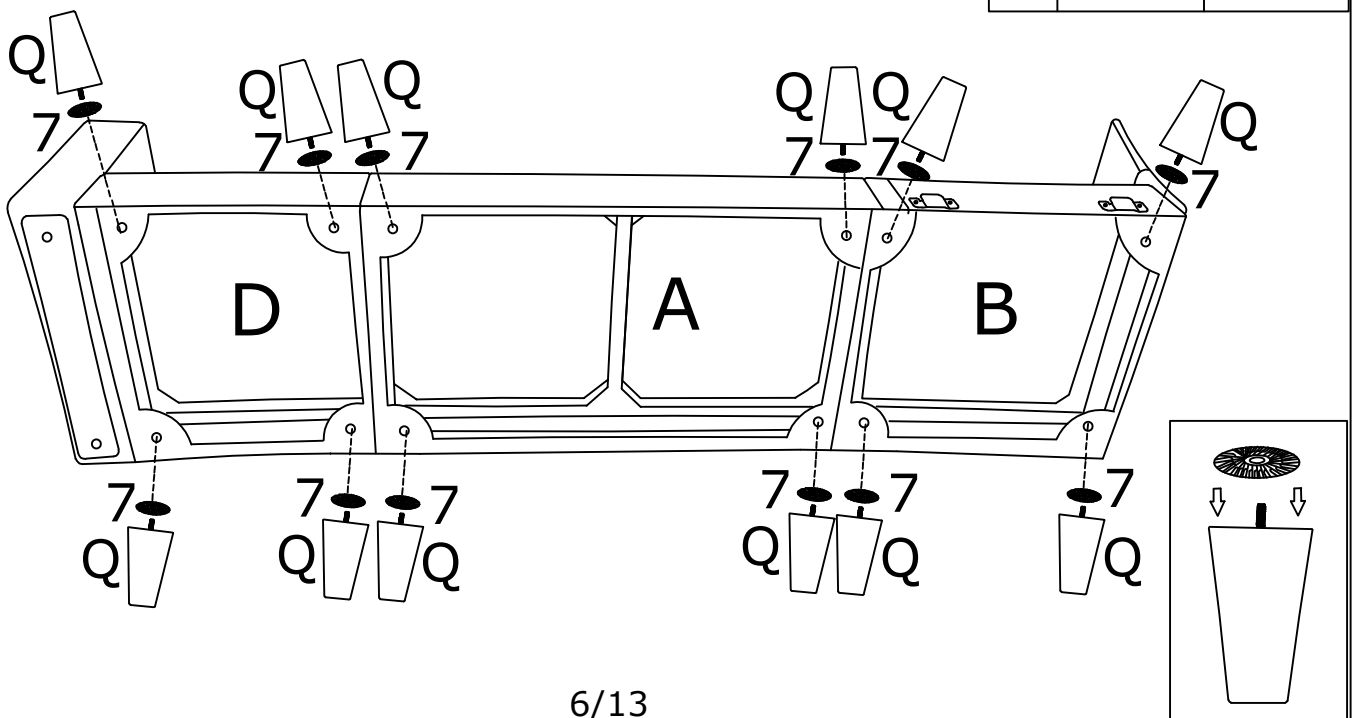



DIAGRAM 5 (Assemble the Legs)

Tighten 4 Legs (Parts Q) by Plastic gasket(Hardware 7).

7		4PCS
Q		4PCS

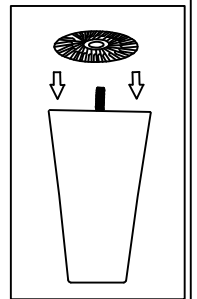
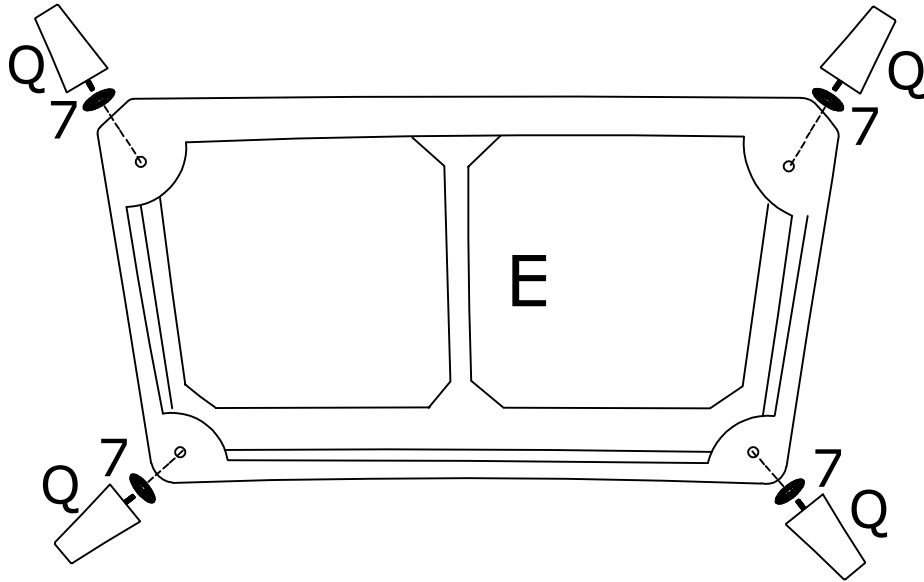



DIAGRAM 6 (Assemble the Legs)

Tighten 4 Legs (Parts Q) by Plastic gasket(Hardware 7).

7		4PCS
Q		4PCS

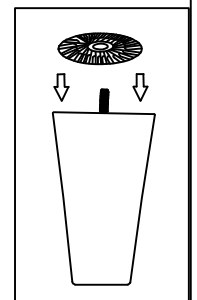
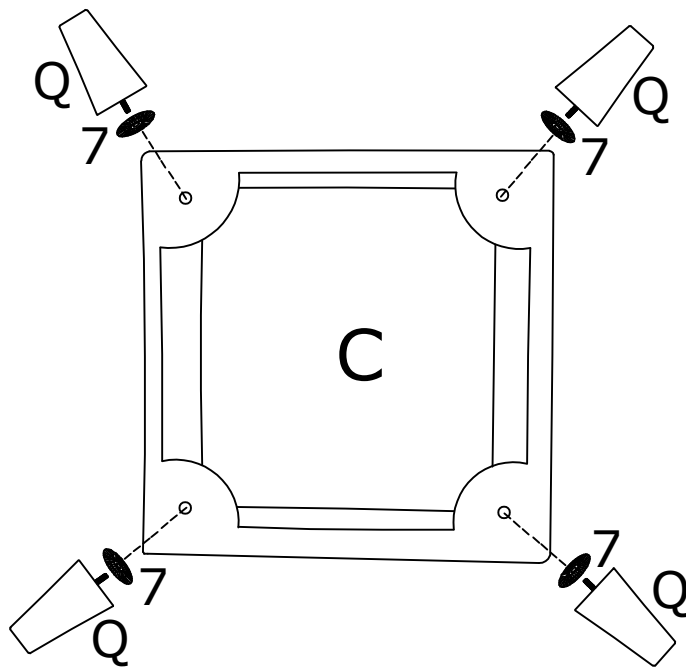





DIAGRAM 7 (Assemble the Back frame)

Connect the Back frame (Parts G) and Corner back frame (Parts R) with the Screws M8X40 (Hardware 2) and Screws M8X80 (Hardware 4) the Washer (Hardware 1) by Wrench (Hardware 6).

Please install the top screws first, then the bottom screws.
Make sure all the screws are in the holes before tightening all the screws.

1		16PCS
2	 M8X40	8PCS
4	 M8X80	8PCS

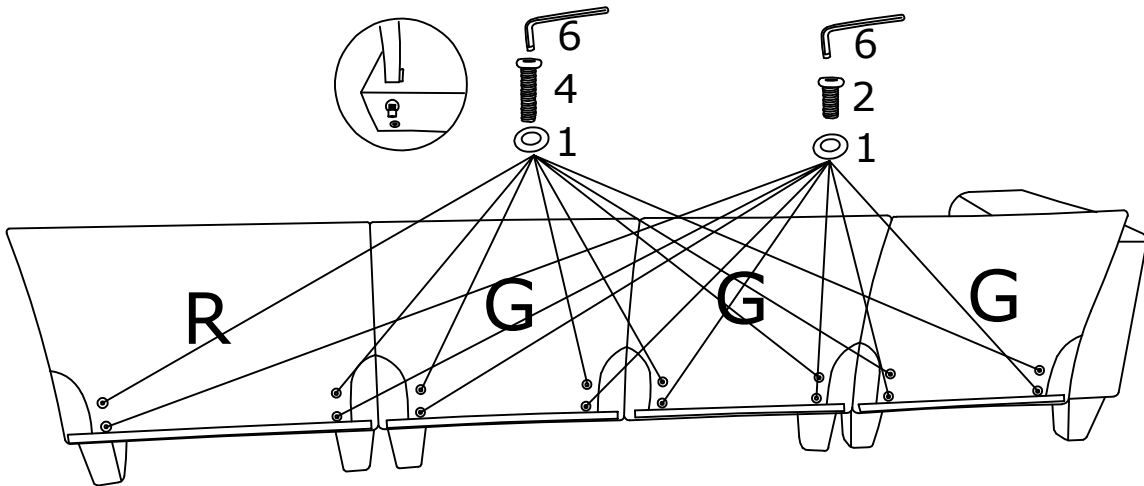





DIAGRAM 8 (Assemble the Back frame)

Connect the Corner back frame (Parts R) with the Screws M8X40 (Hardware 2) and Screws M8X80 (Hardware 4) the Washer (Hardware 1) by Wrench (Hardware 6).

Please install the top screws first, then the bottom screws.
Make sure all the screws are in the holes before tightening all the screws.

1		4PCS
2	 M8X40	2PCS
4	 M8X80	2PCS

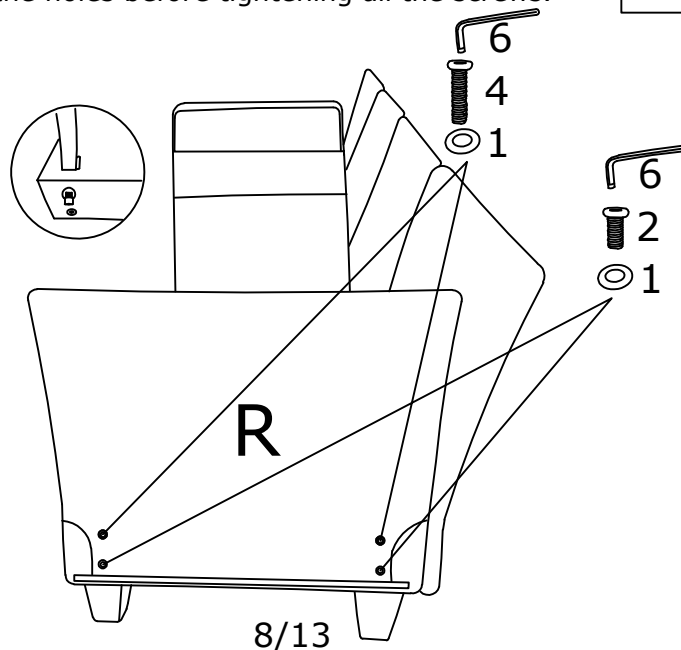





DIAGRAM 9 (Assemble the Back frame)

Connect the Back frame (Parts G) with the Screws M8X40 (Hardware 2) and Screws M8X80(Hardware 4) the Washer (Hardware 1)by Wrench (Hardware 6).

Please install the top screws first, then the bottom screws.
Make sure all the screws are in the holes before tightening all the screws.

1		4PCS
2	 M8X40	2PCS
4	 M8X80	2PCS

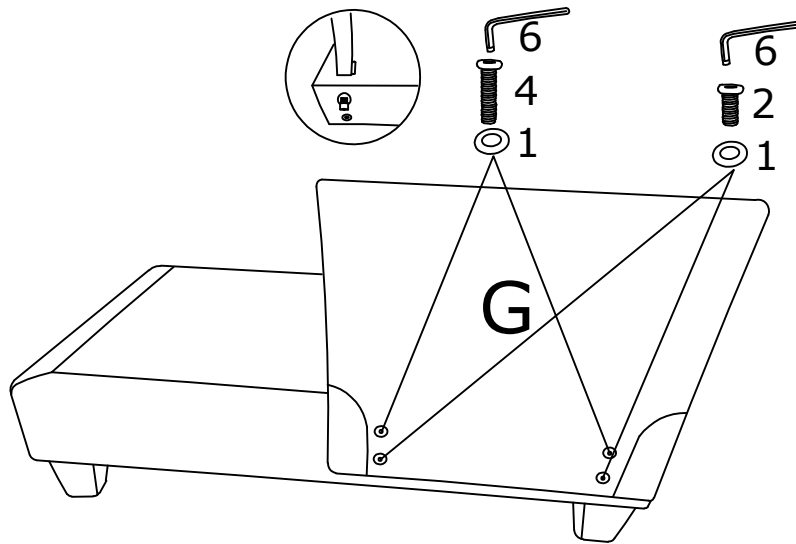

DIAGRAM 10 (Connecting the Seat frame to the Corner wood frame)

Connect the Seat frame (right) (Parts E) to the Corner wood frame (Parts B).

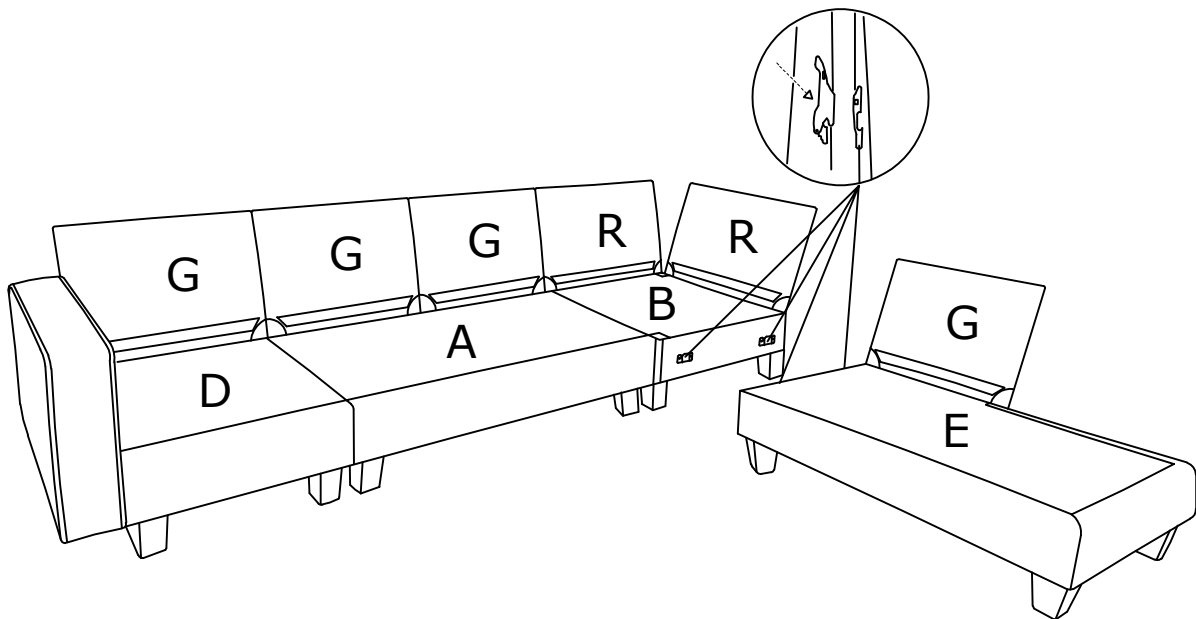

DIAGRAM 11 (Put the Back cover on the Back frame)

Place the Back cover (short) (Parts P) and Back cover (long) (Parts O) on the Back frame.

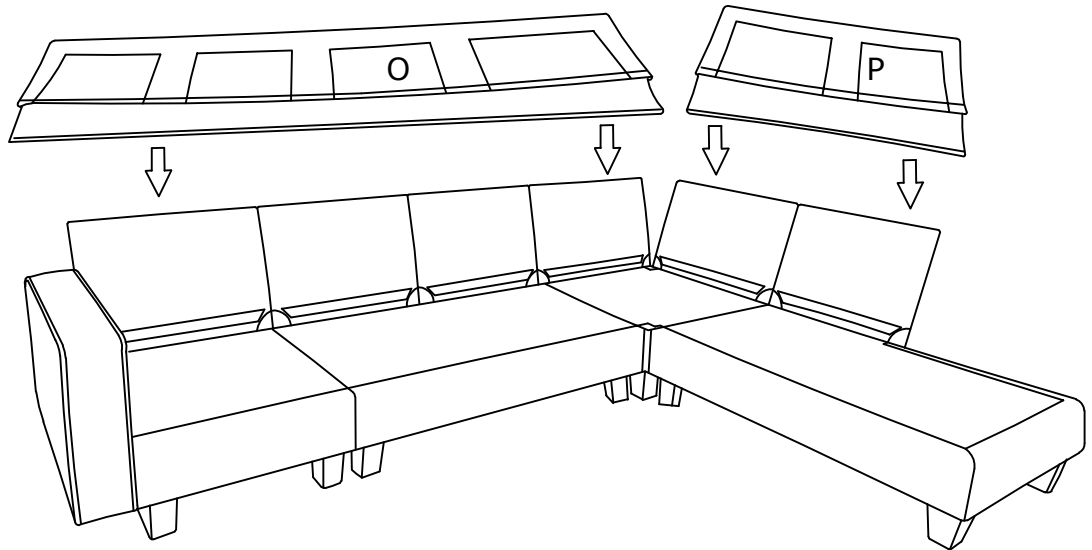

DIAGRAM 12 (Removal of compression bags)

Remove the Seat cushion(Parts H)the Corner seat cushion(Parts I) the Seat cushion(Parts J).

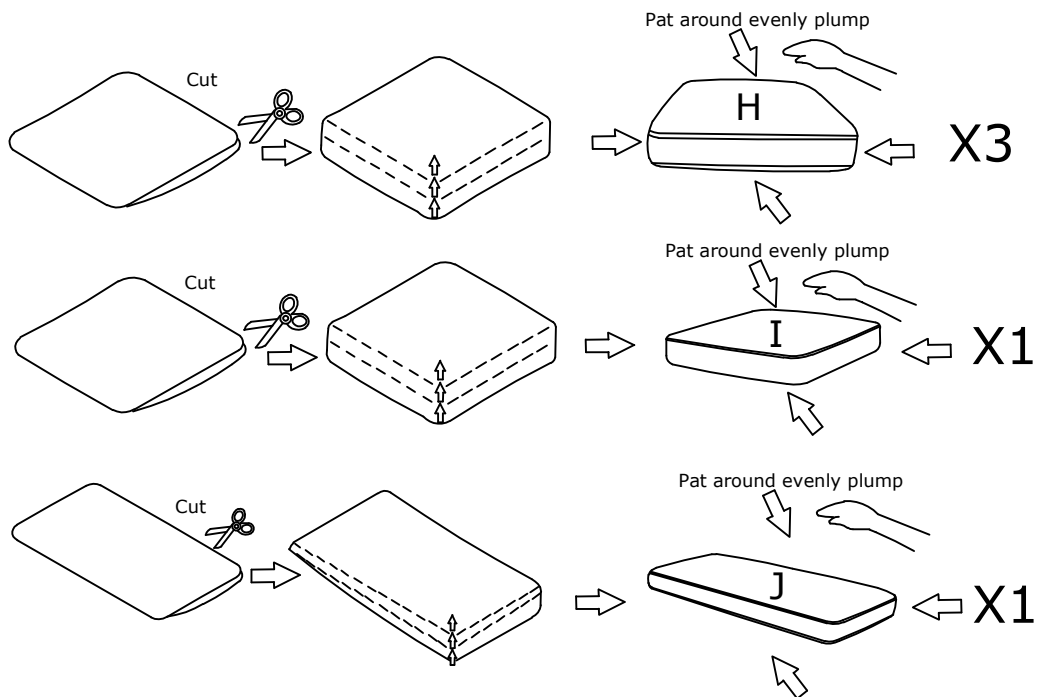
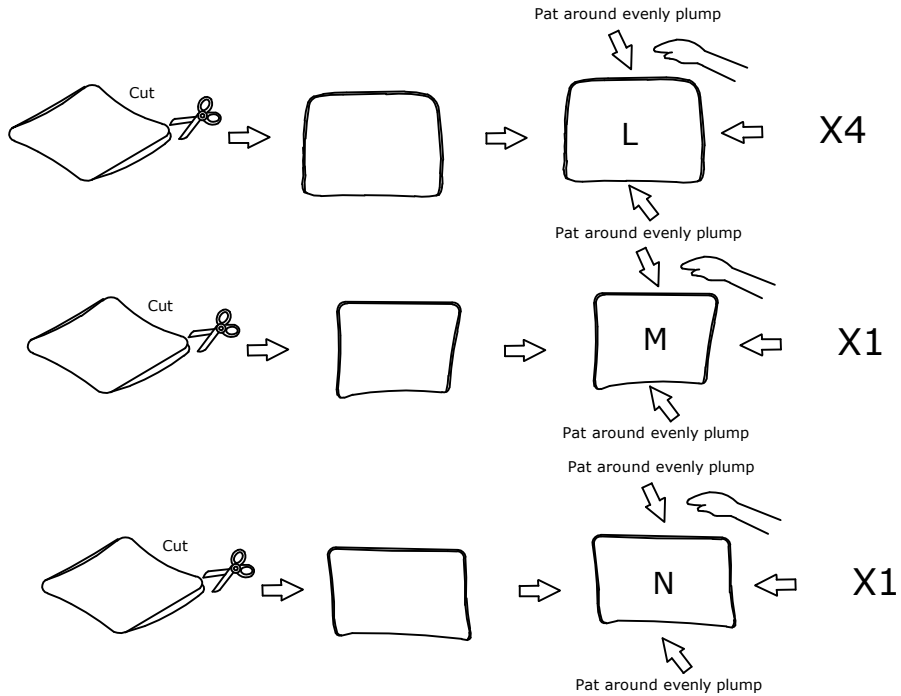

DIAGRAM 13 (Removal of compression bags)

Remove the Back cushion (Parts L) the Corner back cushion (left) (Parts M) the Corner back cushion (right).



TIPS:

1. Please do not open the compressed packages until your sofa frame is completely assembled.
2. Compressed back cushions and pillows need to be fully fulfilled within 72 hours for your perfect use.
3. Please keep children away from plastic bags or any small pieces of stuff.

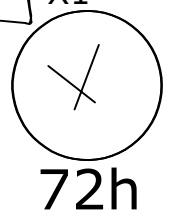
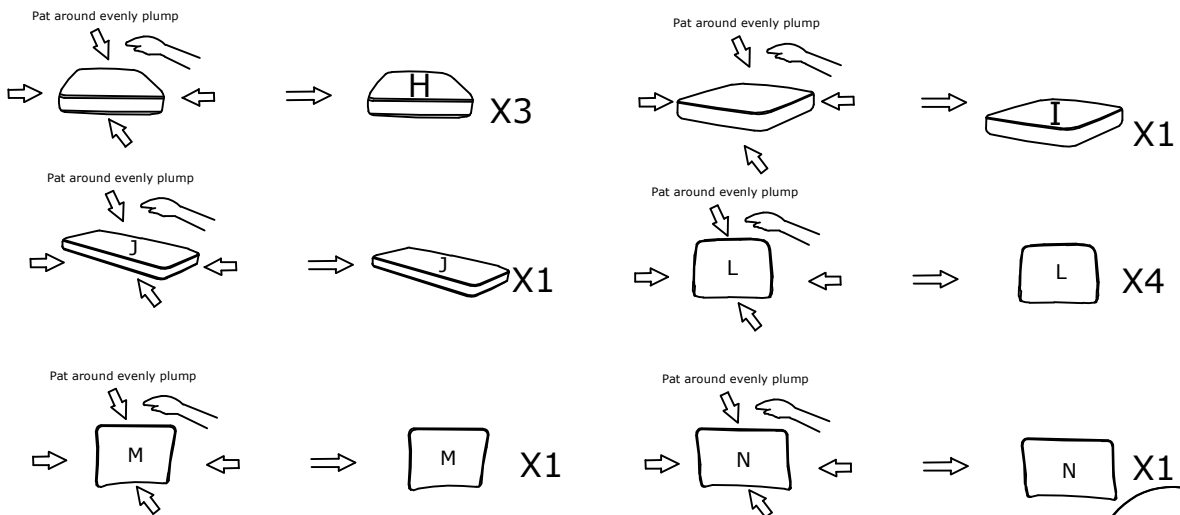

DIAGRAM 14 (Place the Seat cushion on the sofa)

Put the Seat cushion (Parts H) Corner seat cushion (Parts I) Seat cushion (Parts J) on the sofa.

Recheck all the bolts before you sit on the sofa.

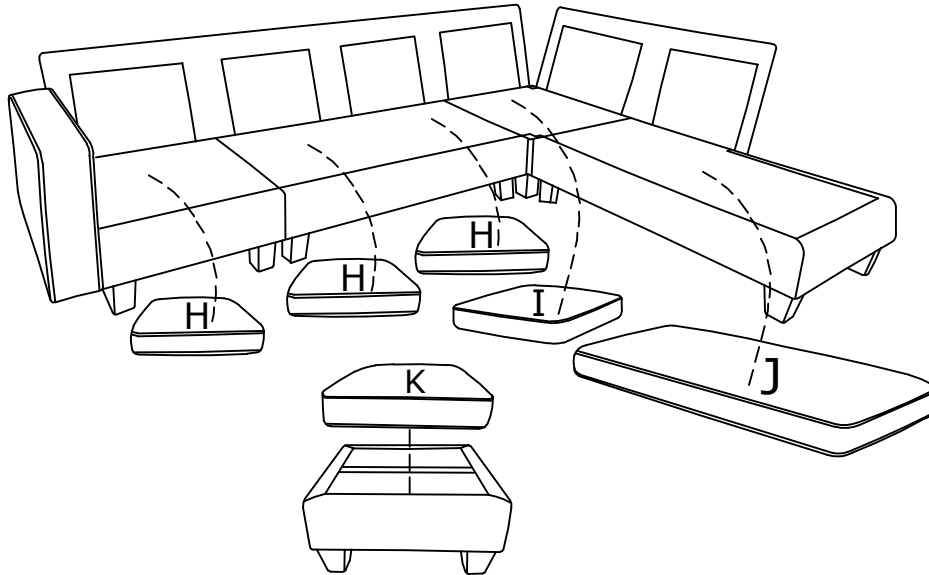
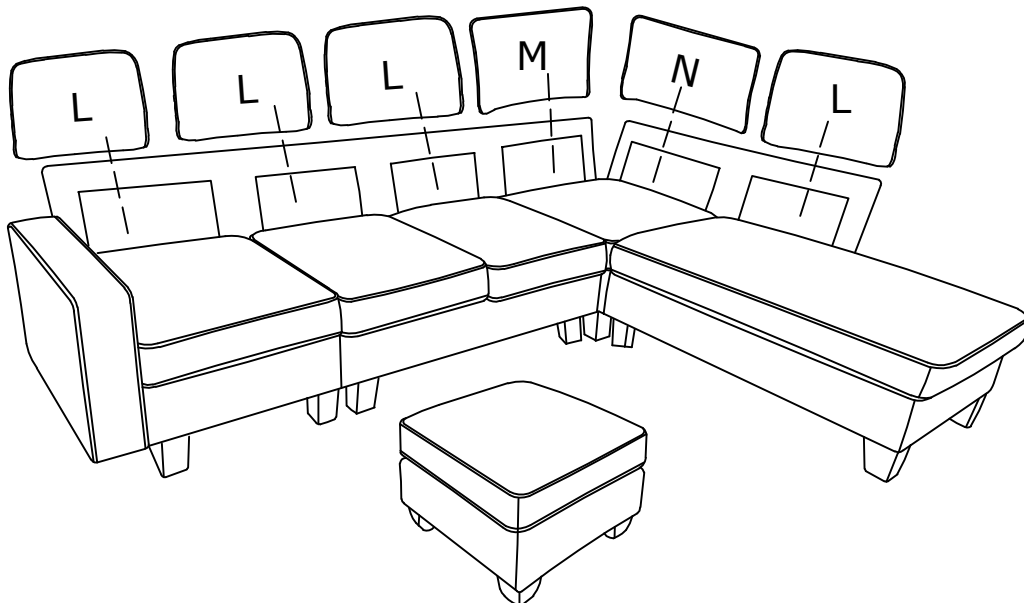

DIAGRAM 15 (Place the Back cushion on the sofa)

Put the Back cushion (Parts L) Corner back cushion (left) (Parts M) Corner back cushion (right) (Parts N) on the sofa.



TIPS:

1. Please do not open the compress packaging until your sofa frame is completely assembled.
2. Compress back cushions and pillows need to be fully fulfilled within 72 hours for your perfect use.
3. Please keep children away from plastic bags or any small pieces of stuff.

