

TOV



Follow us!

Show your new purchase some love by tagging it on our Instagram!

 @tovfurniture

 516-888-3355

 hello@tovfurniture.com

 www.tovfurniture.com

If the future is female—your furniture should be, too. No mahogany in sight. Sexy settees shaped like lips. Price points for any budget. At TOV, we do things differently.

TOV

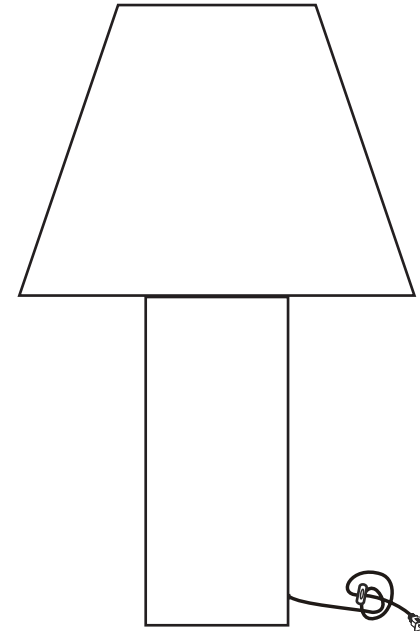

Stamp Blue Pleated Table Lamp

DON'T BE BORING.

Hardware and Components

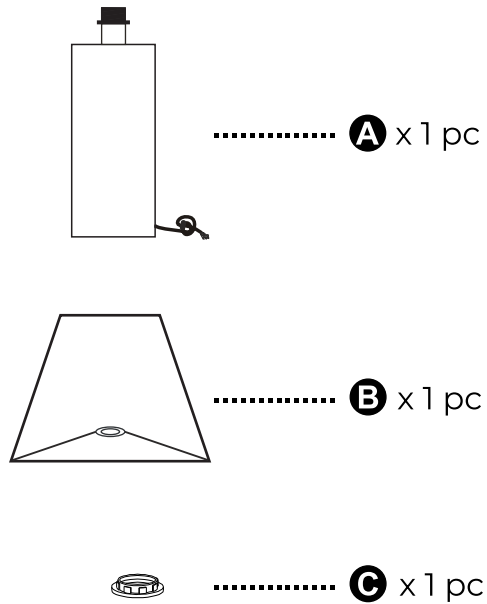

Step 1

Turn the holder ring (C) counter clockwise to loosen and remove it.

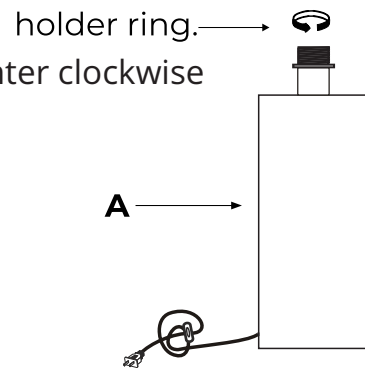

Step 2

Place shade (B) on the lamp base. (A)

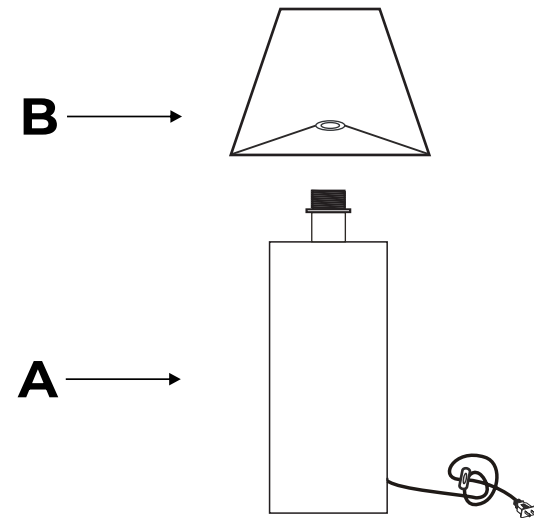

Step 3

Reattach and tighten the holder ring (C), by turning it clockwise.

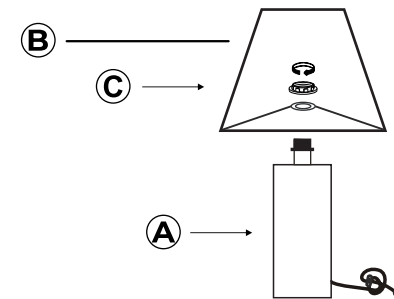

Stuck?

Contact our team @ 516-888-3355

Scan for product care!



TOV



Follow us!

Show your new purchase some love by tagging it on our Instagram!

 @tovfurniture

 516-888-3355

 hello@tovfurniture.com

 www.tovfurniture.com

If the future is female—your furniture should be, too. No mahogany in sight. Sexy settees shaped like lips. Price points for any budget. At TOV, we do things differently.

TOV

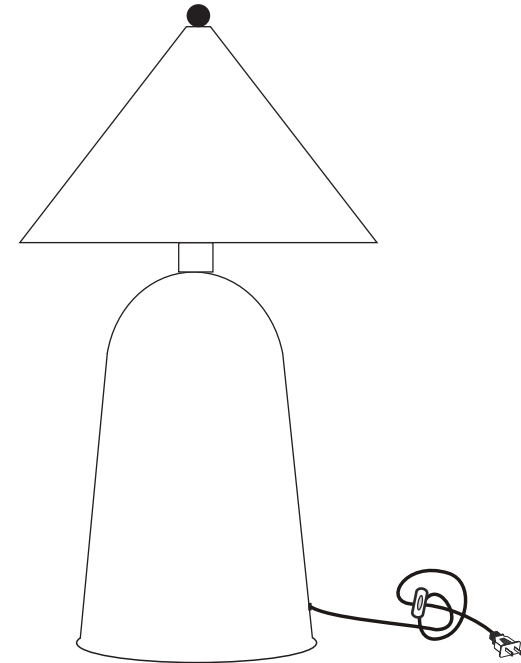

Coco Coconut Fibre Pointed Table Lamp

DON'T BE BORING.

Hardware and Components

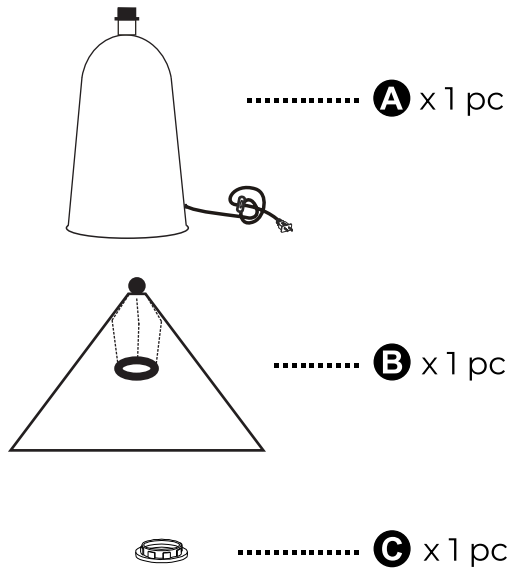

Step 1

Turn the holder ring (C) counter clockwise to loosen and remove it.

holder ring. → 

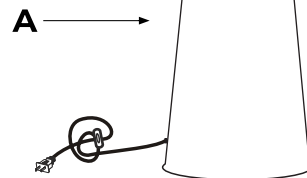

Step 2

Place shade (B) on the lamp base. (A)

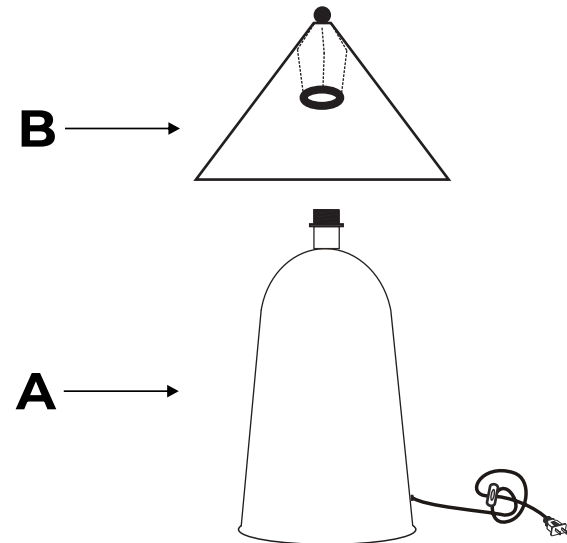

Step 3

Reattach and tighten the holder ring (C), by turning it clockwise.

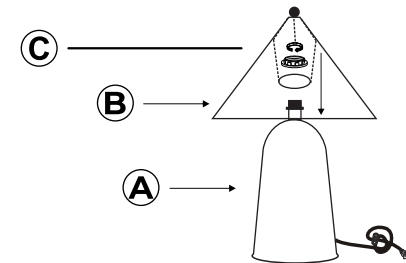

Stuck?

Contact our team @ 516-888-3355

Scan for product care!



TOV



Follow us!

Show your new purchase some love by tagging it on our Instagram!

 @tovfurniture

 516-888-3355

 hello@tovfurniture.com

 www.tovfurniture.com

If the future is female—your furniture should be, too. No mahogany in sight. Sexy settees shaped like lips. Price points for any budget. At TOV, we do things differently.

TOV

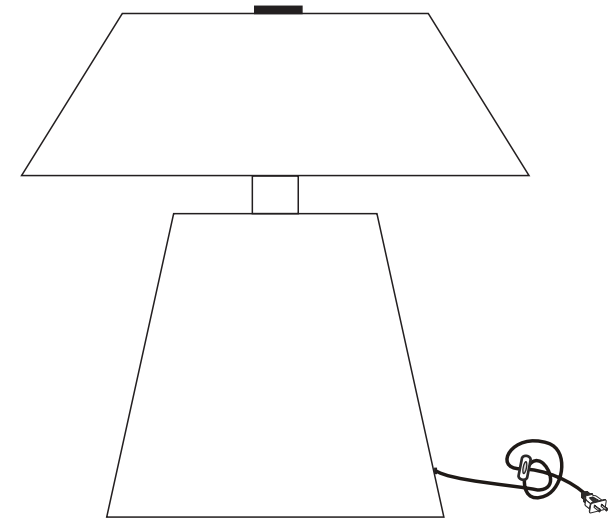

Pouty Pink Resin Table Lamp

DON'T BE BORING.

Hardware and Components

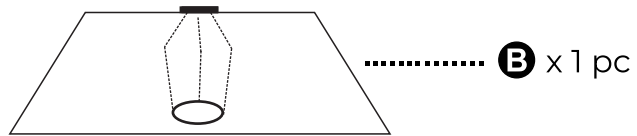
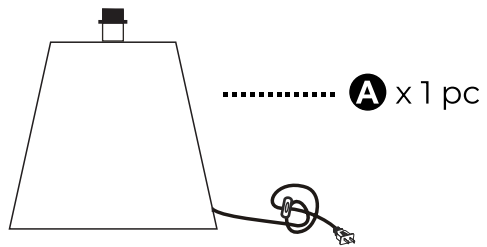

Step 1

Turn the holder ring (C) counter clockwise to loosen and remove it.

holder ring. → 

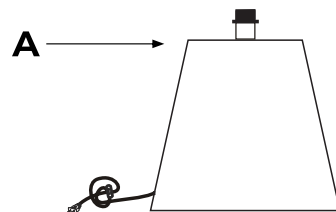

Step 2

Place shade (B) on the lamp base. (A)

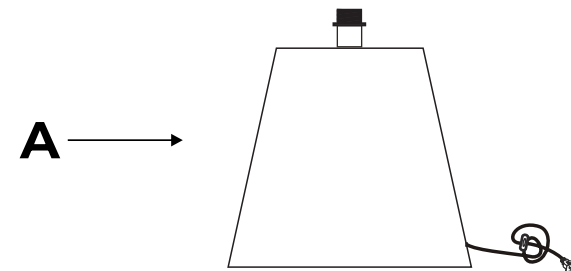
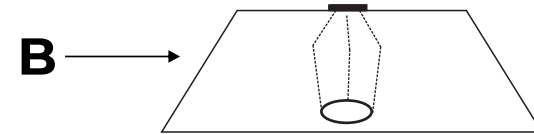

Step 3

Reattach and tighten the holder ring (C), by turning it clockwise.

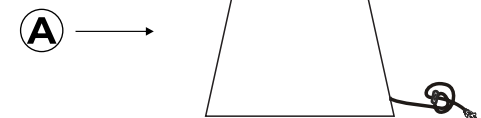
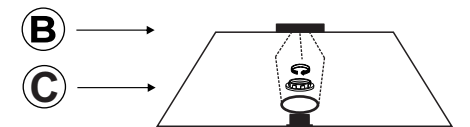

Stuck?

Contact our team @ 516-888-3355

Scan for product care!



TOV



Follow us!

Show your new purchase some love by tagging it on our Instagram!

 @tovfurniture

 516-888-3355

 hello@tovfurniture.com

 www.tovfurniture.com

If the future is female—your furniture should be, too. No mahogany in sight. Sexy settees shaped like lips. Price points for any budget. At TOV, we do things differently.

TOV

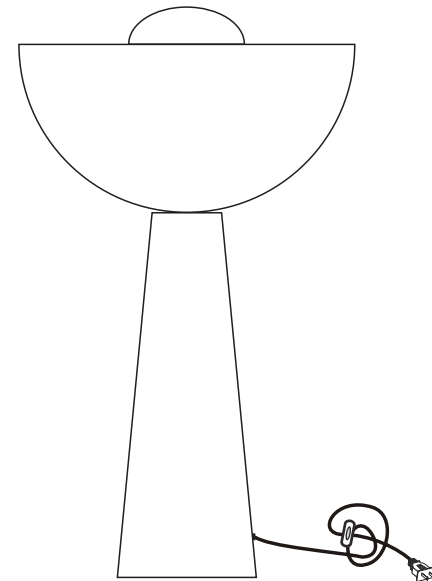

Rising Green Resin Table Lamp

DON'T BE BORING.

Hardware and Components

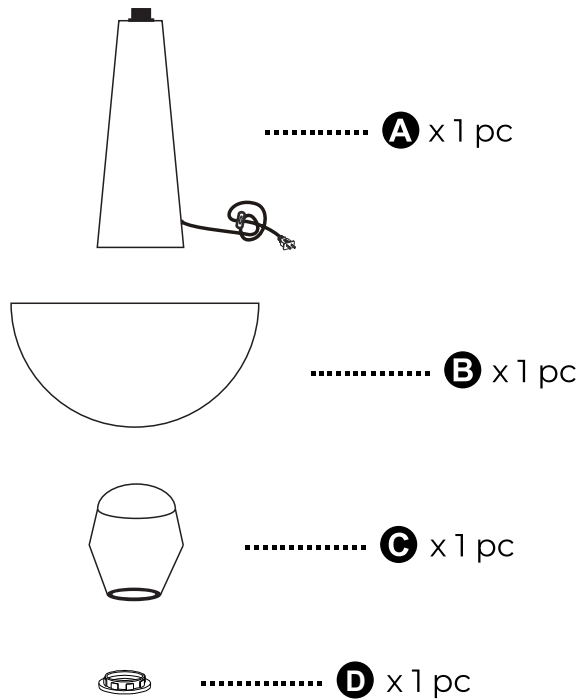

Step 1

Turn the holder ring (D) counter clockwise to loosen and remove it.

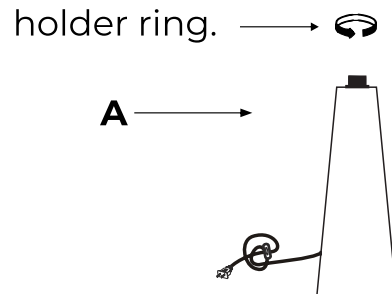

Step 2

Place shade (B) on the lamp base (A), and place the harp (C) on the holder.

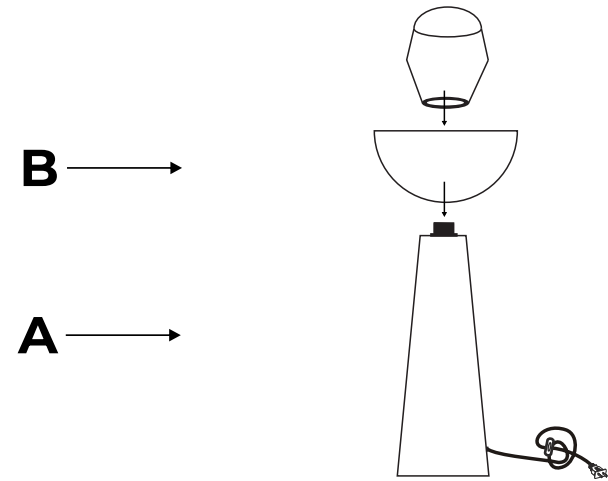

Step 3

Reattach and tighten the holder ring (D), by turning it clockwise.

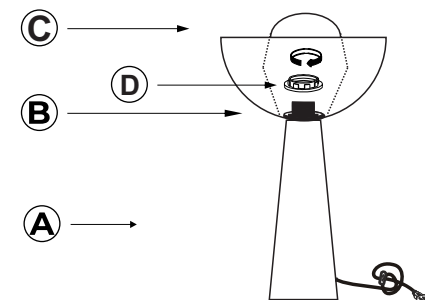

Stuck?

Contact our team @ 516-888-3355

Scan for product care!

