

# Assembly Instructions

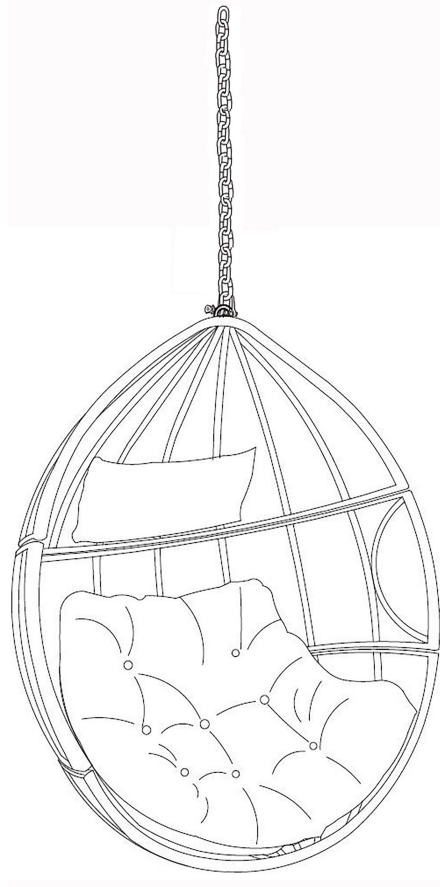









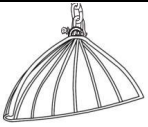
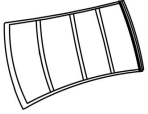
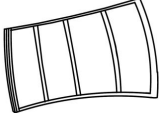
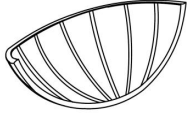

## Hanging Chair



**⚠ WARNING:**

**Thank you for purchasing the Hanging Chair. Please read below before you proceed.**

- 1. Not intended for use by children 12 years of age or younger.**
- 2. This is a hanging chair, not a swing chair.**
- 3. The hanging chair should be installed no more than 20" above ground.**
- 4. The hanging chair should be installed at a minimum of 4-5 feet away from the walls.**
- 5. The hanging chair should have a minimum clearance of 30" from any obstacles.**
- 6. Do not swing on or in the chair. It could cause the product to tip over, resulting in possible injury.**
- 7. This chair basket is not a toy.**
- 8. No mounting hardware kit included.**
- 9. Professional installation required.**

<b>Part List</b>			
Label	Picture	Description	QTY
A		Top	1
B		Right Back	1
C		Left Back	1
D		Seat	1
E		Pillow	1
F		Cushion	1
G		Long Chain (8 ft.) with Carabiners	1
<b>Hardware</b>			
Label	Picture	Description	QTY
①		Bolt (M6x40mm)	13
②		Bolt (M6x45mm)	3
③		Washer (M6)	27
④		Nut	13
⑤		Bolt Cap	15
⑥		Nut Cap	13
⑦		Spanner	1
⑧		Allen Key	1



- *Read the instructions before you start the assembly.*



- *May need assistance for assembly.*



- *Assemble on a clean and smooth surface.*



- *Save all package until finished.*

## Assembly Steps

### Overview

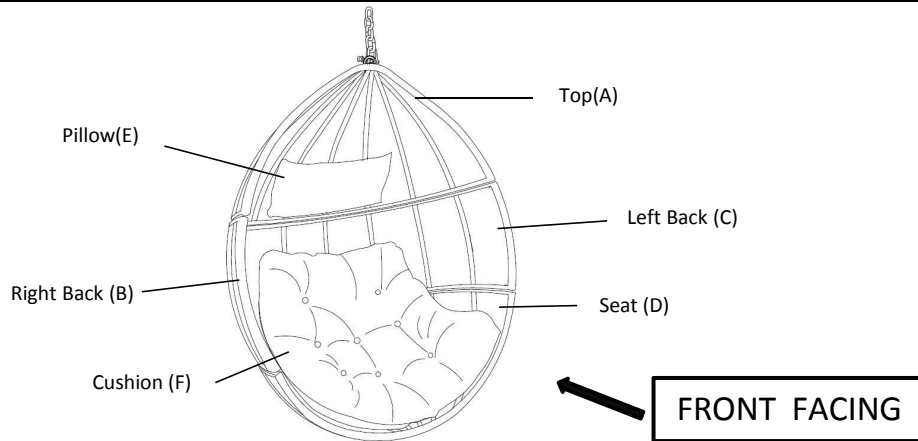

This Basket has multiple parts and may require up to 30 minutes to assemble. The above picture is to help you put the various parts into perspective. Please read through the instructions below to familiarize yourself with the parts and steps before assembly.

### Step 1

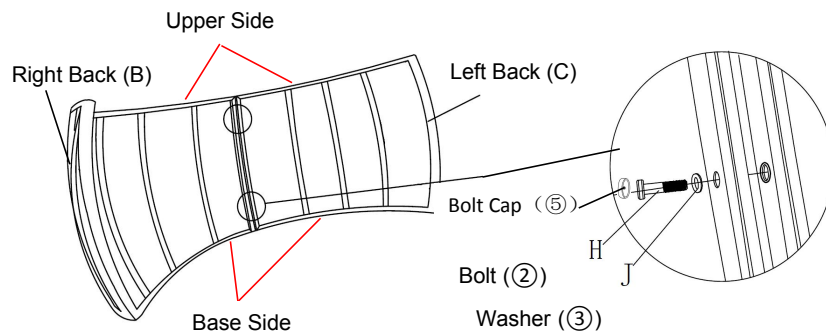

Place the Right Back(B) and Left Back(C) on a clean, non-marring surface.

**Note: Find the sticker with the words "upper side" on them, and keep all the upper sides upwards.**

Attach Right Back(B) to Left Back(C) using Bolts(2) and Washers(3) and Bolt Cap(5) with Allen Key(8).

**Do not fully tighten the Bolts.**

## Step 2

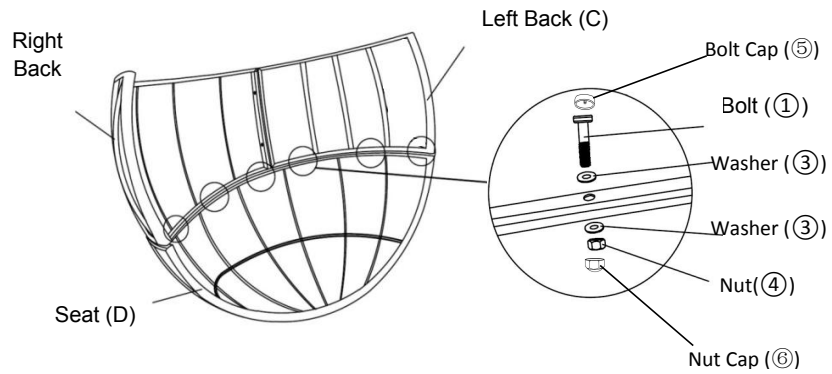

Align Right Back(B), Left Back(C) and Seat(D).

Attach Right Back(B) and Left Back(C) to Seat(D) using Bolts(1), and Washers(3) and Bolt Cap (5) on the upper side and Washers(3) and Nuts(4) and Nut Cap (6) on the lower side, with Allen Key(8) and Spanner(7).

**Do not fully tighten the Bolts.**

## Step 3

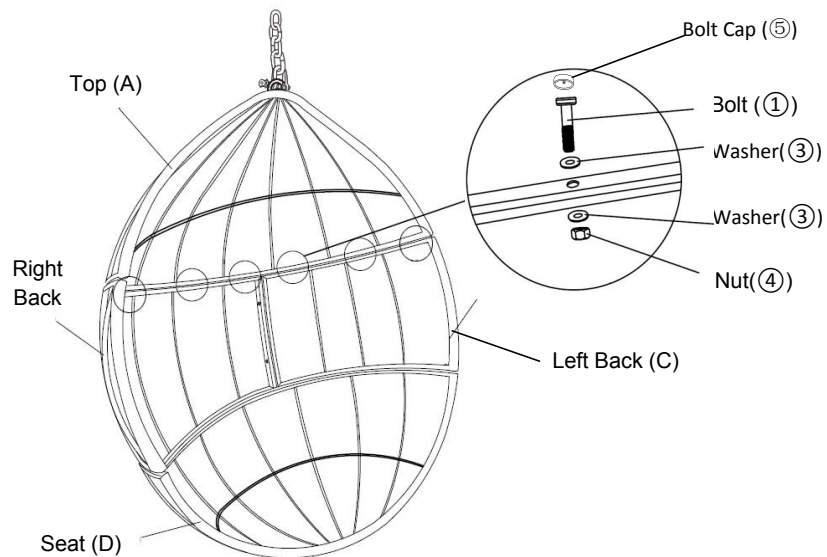

Align Right Back(B), Left Back(C) and Top(A).

Attach Right Back(B) and Left Back(C) to Top(A) using Bolts(1), and Washers(3) on the upper side and Washers(3) and Nuts(4) on the lower side, with Allen Key(8) and Spanner(7).

**Do not fully tighten the Bolts.**

## Step 4

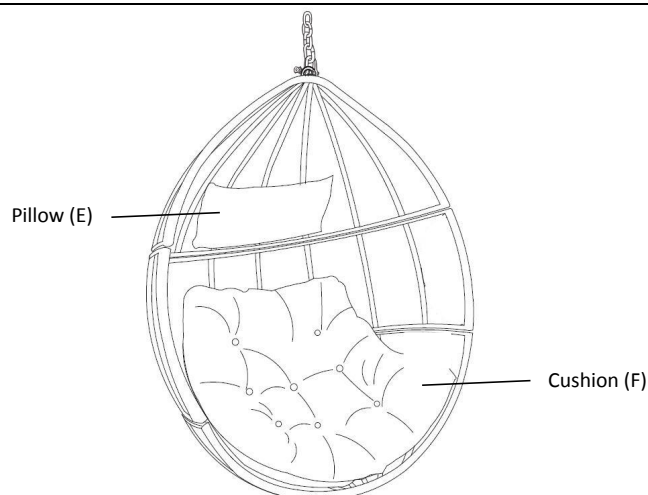





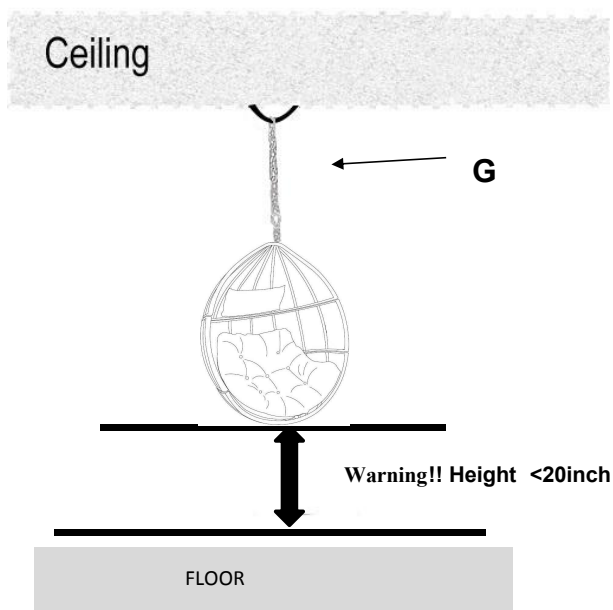





**Now, tighten all Bolts and Nuts at all joints sequential manner.**  
 Place Bolt Caps(⑤) on all Bolts(①), and Bolts(②); and Nut Caps(⑥) on Nuts(④).  
 Tie the Pillow(E) to the Basket as pictured above.  
 Place the Cushion(F) on the Basket.  
 Your Basket is ready for use.

### **Step 5**



Install 8ft chain with 2 Carabineers (G) to the basket, your hanging chair is ready for next step.

### **Care & Maintenance**

- ⊘  • Prolonged exposure to rain may cause rusting which can stain floors.
- ⊘  • Do not put hot items directly on furniture surface.
- ⊘  • Do not clean furniture with harsh cleansers or polish.
- ✓  • To obtain the longest lifespan of your outdoor products, minimizing exposure to direct sunlight is recommended.
- ⊘  • Children should not climb or jump on the furniture.
- ⊘  • Do not write on furniture without a padded barrier to protect the surface.
- ✓  • To obtain the longest lifespan of your outdoor products, avoid extended and lengthy exposure to rain, snow, and direct sunshine. Whenever possible cover the product and /or place under patio or awnings.
- ⊘  • Not for commercial use. For residential use only.
- ✓  • Stains may be removed with mild soap solution and damp cloth.
- ✓  • Keep away from sources of ignition.
- ✓  • Dust and pick-up spills using a clean, non-colored, lint-free cloth.