

# DREAMS

IDEA

Instruction Manual



# ABOUT US

DREAMSIDEA IS A ONE-STOP HOME  
FURNISHING AND SERVICE COMPANY BASED IN USA.  
WE ARE DEDICATED TO BRING YOUR DREAM HOME TO LIFE.  
OUR SERVICES COVER FROM DESIGN, PRODUCTION,  
DIRECT SELL, STORAGE, AND TRANSPORTATION.

IF REALITY IS THE NEAR SHORE  
AND IDEALISM THE FAR SHORE,

DREAMSIDEA  
AS THE FERRY BETWEEN THEM,  
EAGER TO ACCOMPANY YOU ON A JOURNEY  
TO YOUR IDEAL HOME.



ITEM NO.OD0004(D)-CHAIR-2ST

# WARRANTY

We strive to offer high quality product and we also try our best to satisfy each customer that order from us, no matter on products or services as needed. Each customer receives a record of their order, such as the order number or item receipt. For any items that are out of warranty period, you may still be able to purchase the replacement parts from our company if they are available.

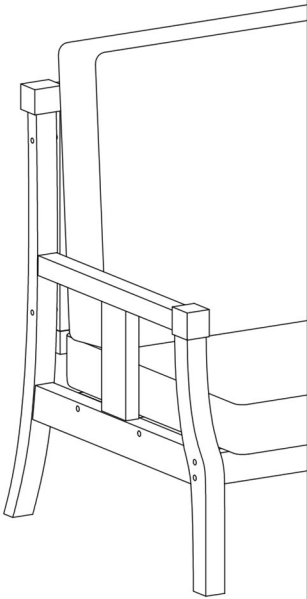

Are you having difficulty  
with assembly? Missing parts?

Please contact us : [info@firstopintl.com](mailto:info@firstopintl.com)

Tel:(562)-781-3327

send an email with your order No. to us

For return, please check the return policy with  
the retailer or platforms you bought from.

Appreciate your purchasing from us.

Pop up your life by our furniture !

# MAINTENANCE AND WARNING

Please read the manual thoroughly  
before you start installing.

Please keep the product away from  
sharp object.

Packaging and small parts may have  
chocking hazard, please keep them away  
from children and pets.

Please clean the product according to each  
clean code, check the product description  
for more information.

Please keep the product away from  
fire.

If you have any other questions, please  
contact us, we will be glad to help you out.

If the product is placed under direct  
sunlight, the pattern or color might fade  
away overtime.

Check the product periodically to make  
sure everything is secured and tightened.

Always use proper tools for installation.

Do not jump on the product.

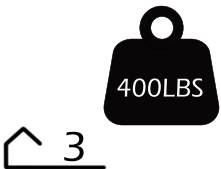

Around 20 min

# PRDOUCT DESCRIPTION

## Premium Solid Teak Construction:

Crafted from high-quality solid teak wood, providing exceptional strength, durability, and natural resistance to decay and outdoor elements.

## Water-Resistant Cushion Fabric:

Cushions are upholstered in specialized cotton-linen fabric, engineered to resist water, UV exposure, and mildew, protecting the foam interior.

**Ergonomic Comfort:** Carefully designed seat and backrest angles offer superior support and comfort for long-term outdoor seating.

**Elegant Garden Aesthetic:** Natural teak grain and warm wood tone enhance terraces, patios, and backyard environments with a refined, outdoor-inspired look.

**Coordinated Outdoor Set:** Includes two chairs and pairs seamlessly with the matching side table for a cohesive, functional outdoor seating arrangement.

Dream



House

# EXPLODED VIEW



The product's left and right are determined by sitting posture

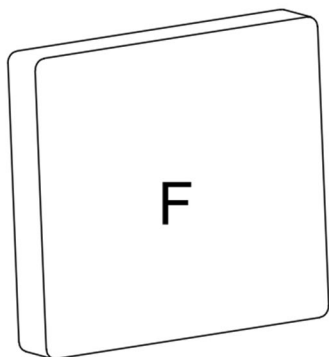

F

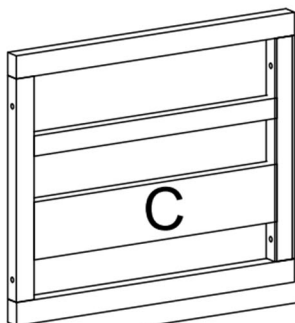

C

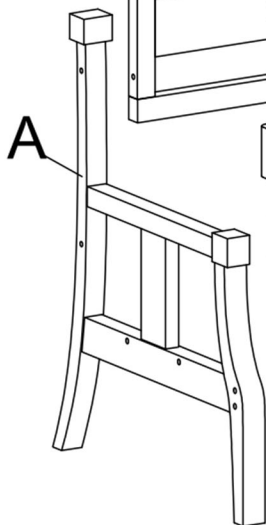

A

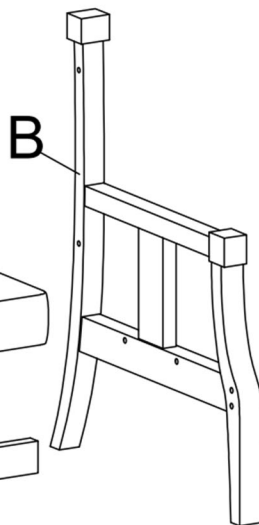

B

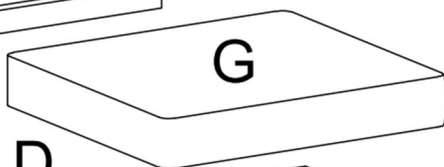

G



D



E

# PARTS

A\*2

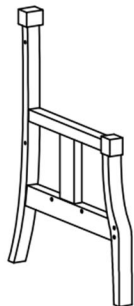

Right arm

B\*2

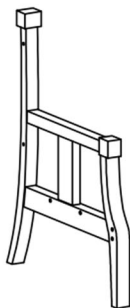

Left arm

C\*2

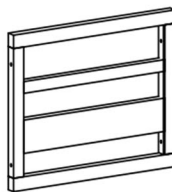

Back frame

D\*4



Seat frame

E\*2



Front rail

F\*2

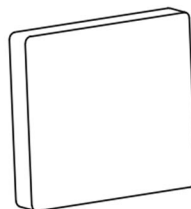

Back cushion

G\*2



Seat cushion

\*This parts list contains accessories for 2 chairs.

# HARDWARE

## TOOL LIST

NOTE: Designated with (★) We provide additional spare parts in the hardware package

①\*24

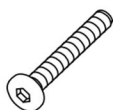

★ M6\*55mm  
Bolts

③\*1

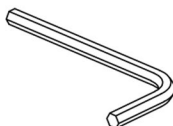

Allen key

④\*8



★ Ø10\*13mm  
Vertical nut

⑤\*24



★ Black hole  
cover

Please make sure all hardware&packing material fitting the list. Especially some small accessories may be missing during transportation. Please contact us if you have any question.

# step 1

After taking out the cushions (G) from the air compression bags, please allow them to recover for a period of time. It may take up to **48** hours to fully recover. You can gently slap them to speed up the process.

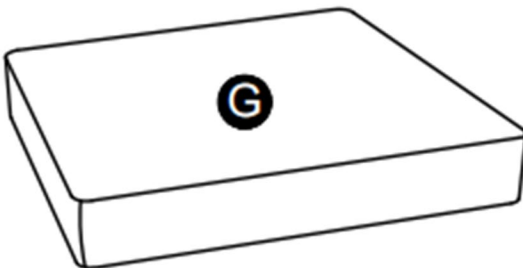
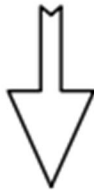
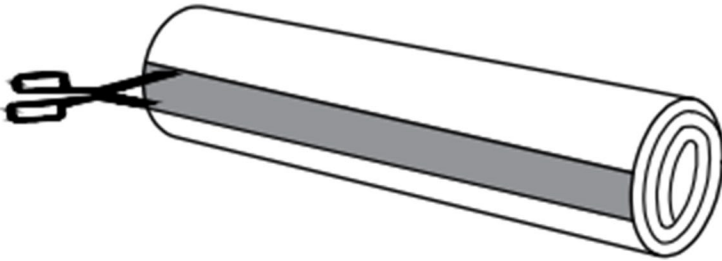

**X2**

# step 2

Insert Vertical Nuts (4) into the designated holes of each support bar (E) as shown. Make sure the holes are aligned with the screw holes on the sides. Align Seat Frame (D) with the Right Armrest (A). Use Screws (1) to attach from the inside, tightening with Allen Wrench (3) provided.

Use Screws (1) and Allen Wrench (3) provided to attach the bars to Armrest (A) as shown.

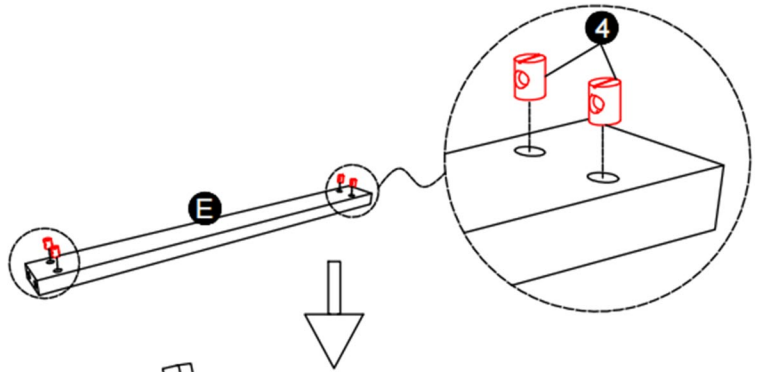

## Notice:

We suggest tightening the bolts for 30-50% first, make sure the process is correct and bolt holes are aligned, then fully tightening them all.

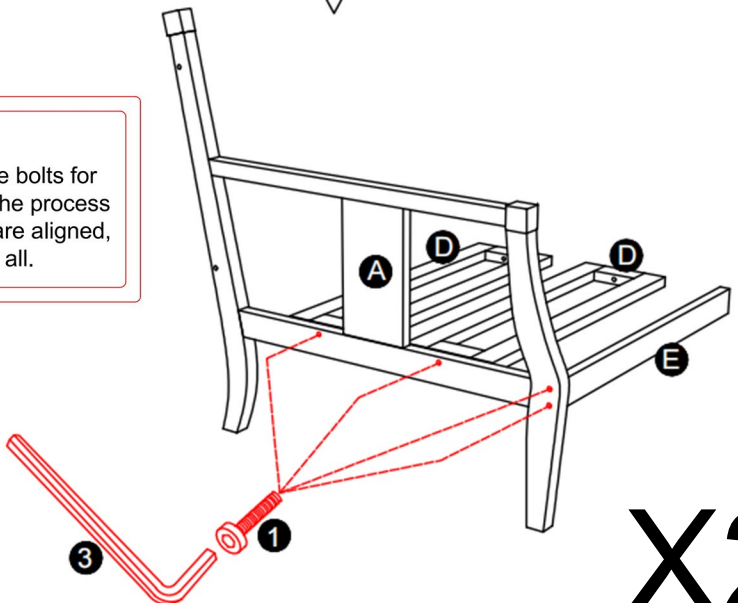

# step 3

Align the Backrest Frame (C) with the holes on armrest as shown. Secure with Screws (1) on both sides and tighten firmly as shown.



**Notice:**

We suggest tightening the bolts for 30-50% first, make sure the process is correct and bolt holes are aligned, then fully tightening them all.

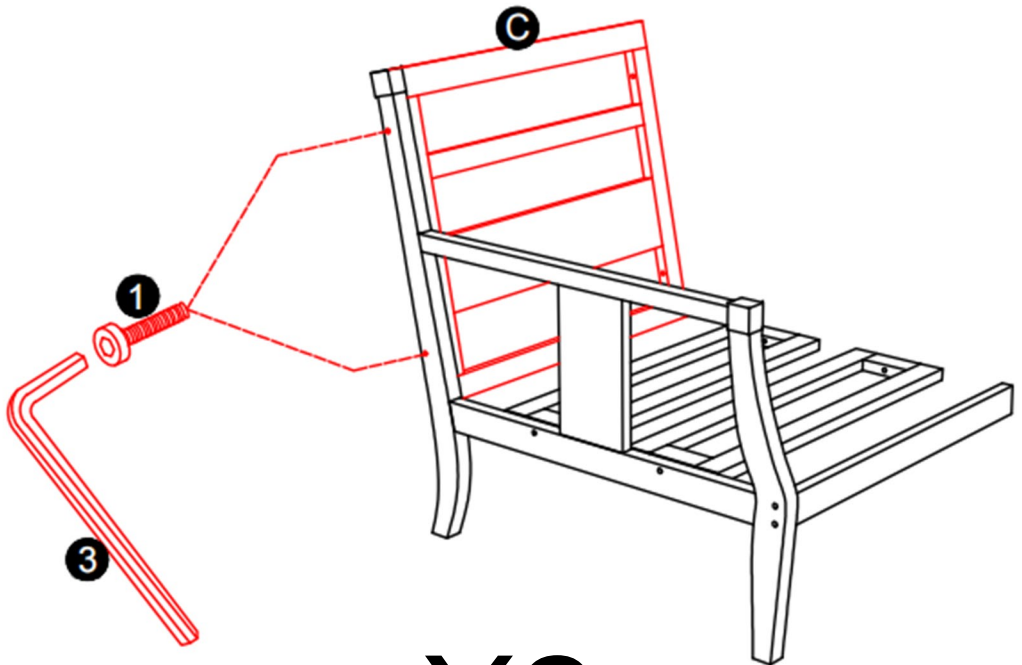

X2

# step 4

Position Left Armrest (B) over connection points. Tighten all Screws (1) on armrest to and seat frame as shown.



## Notice:

We suggest tightening the bolts for 30-50% first, make sure the process is correct and bolt holes are aligned, then fully tightening them all.

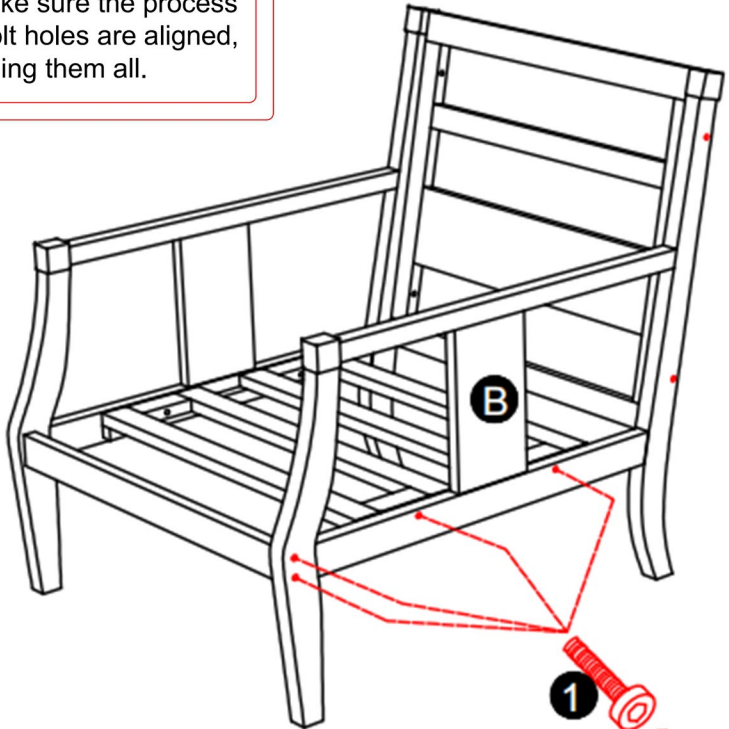

X2

# step 5

Cover each screw hole with Plastic Caps (5). Press down firmly until flush with the surface.

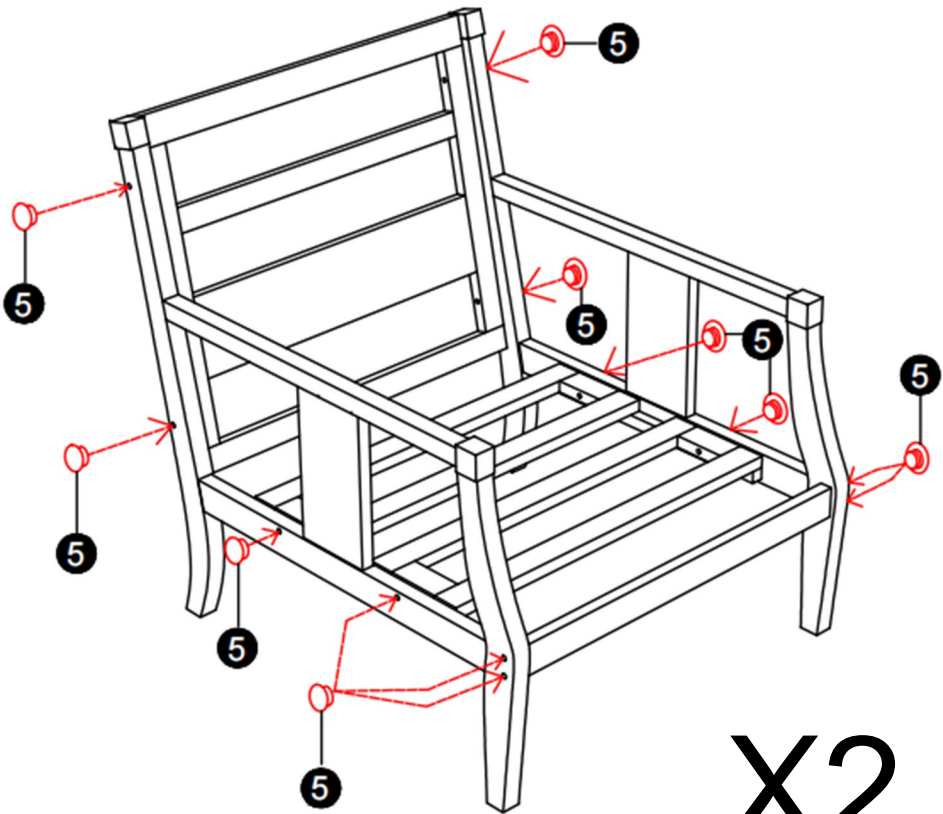

X2

# step 6

Place the Seat Cushion (G) with the tag side up. Place the Back Cushion (F) against the backrest with the tag facing front as shown.

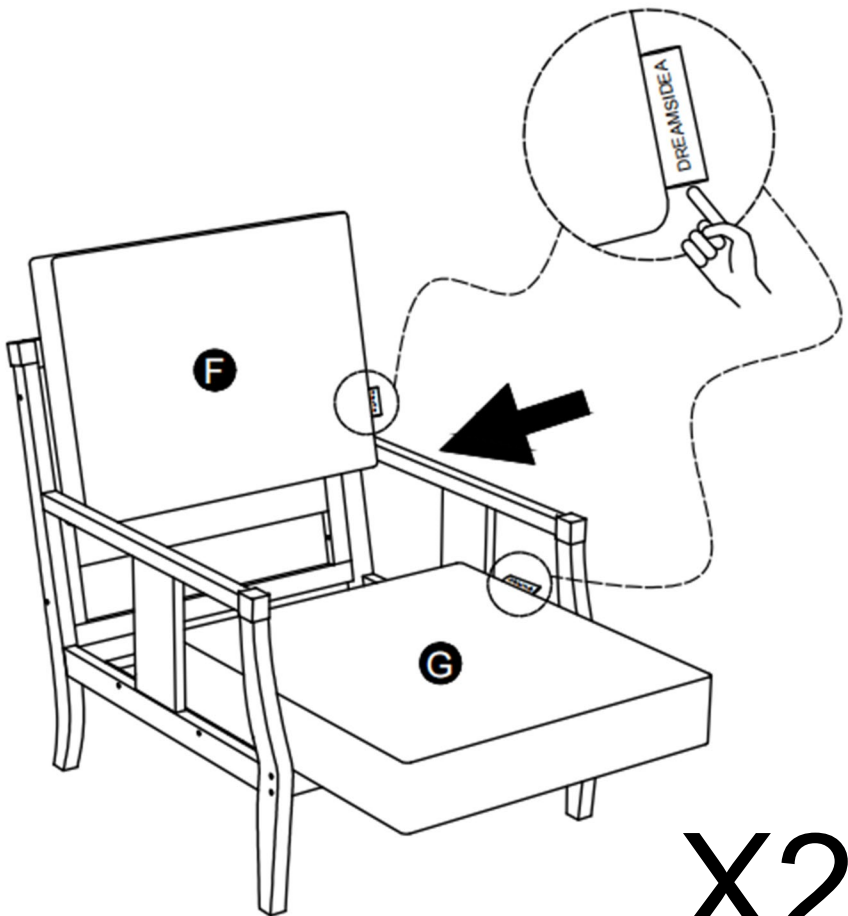

# step 7

Clean up the mess and start enjoy it. congratulation! you have complete the assembly, now it's all yours. thank you for reading!

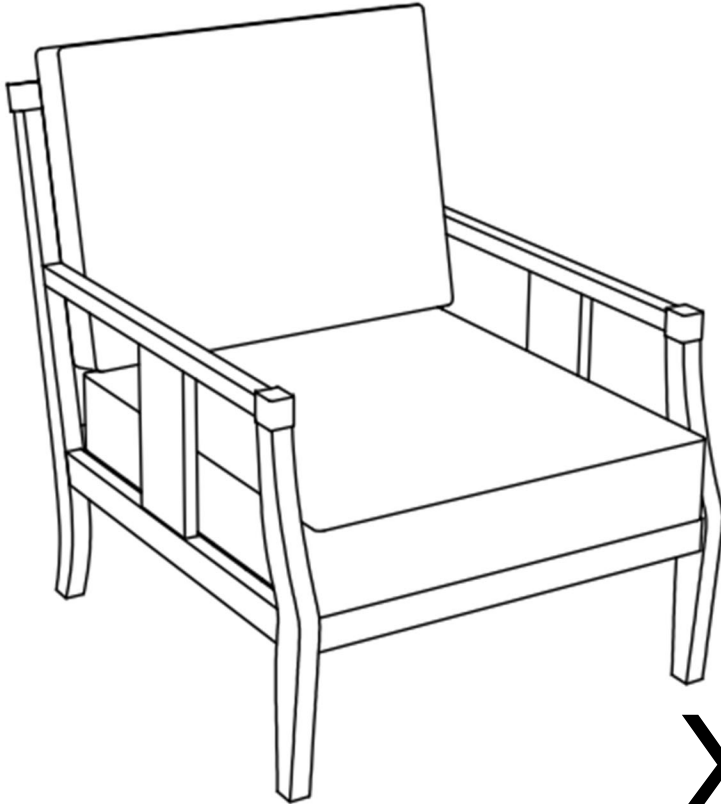

**X2**



## ASSEMBLY INSTRUCTIONS

Tel.(562)-781-3327

Please contact us:[info@firstopintl.com](mailto:info@firstopintl.com)

<https://www.dreamsidea.com>