

**THANK
YOU!**

HOW-TO

USER MANUAL

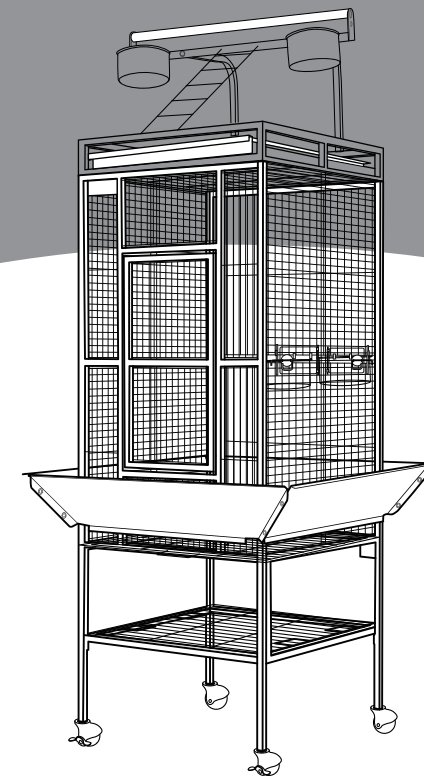
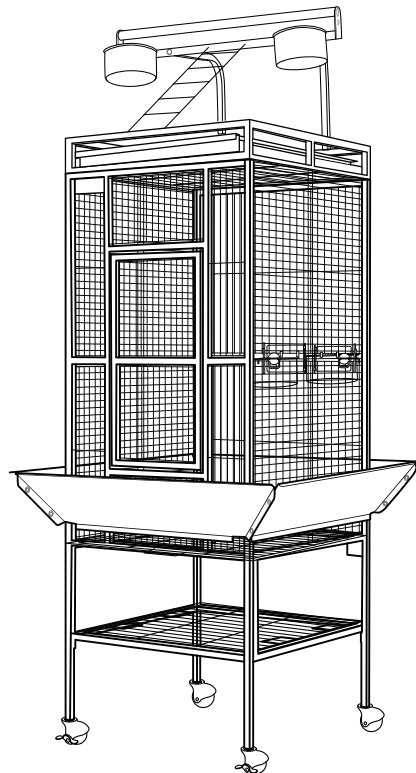

**65 Inch
Large Iron Bird Cage**

Assembly is EASY!

**WE WANT
YOU TO
ENJOY LIFE
AT HOME**

**GO TO THE PRODUCT LISTING PAGE
FOR AN INSTUCTIONAL VIDEO!**

CONTENTS

Warning	1
Note	1
Parts List and Diagram	3
Assembly Steps	5

SECTION A
Warning



1. Children are not allowed to assemble the product. During assembly, keep all small parts out of the reach of children, as it may be fatal to swallow or inhale them.
2. Children are forbidden to climb or play on the product. Climbing or playing on the product may result in serious bodily injuries.



SECTION B
Note



1. The product must be assembled and used in accordance with the provisions of the manual.
2. Avoid long-term exposure to humid environments to prevent mildew.
3. Keep the product away from fire sources and high temperatures.
4. DO not place any hot objects directly on the surface of the product.
5. If there are any defective or missing parts after unpacking, please cease assembly immediately and contact US.
6. Please assemble the item on a spacious surface; to avoid product damage, do not place the unwrapped product directly on the ground.
7. Please keep the product away from sharp, pointed objects and corrosive substances to prevent product damage.

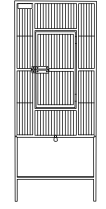
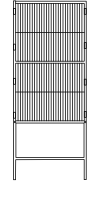
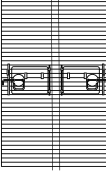
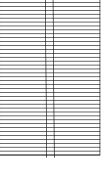
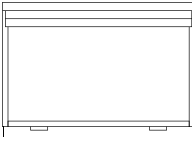
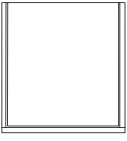
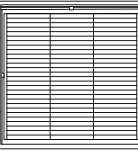

SECTION C
Parts List and Diagram

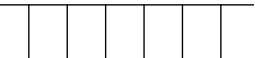

Item No.	Reference Image	Qty.	Item No.	Reference Image	Qty.
A	 44.5(L)*18.1(w) in.	x1	B	 44.5(L)*18.1(W) in.	x1
C	 29.3(L)*16.5(W) in.	x1	D	 29.3(L)*16.5(W) in.	x1
E	 12(L)*17.1(w) in.	x2	F	 17.5(L)*16.5(W) in.	x2
G	 18.1(L)*18.1(w) in.	x1	H	 25.6(L) in.	x2
I	 25.6(L) in.	x2	J	 13.0(L)*3.0(w) in.	x1

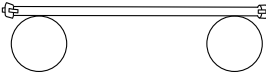

Parts List and Diagram

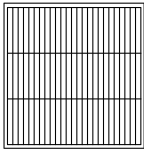
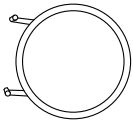
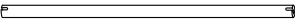
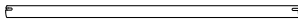
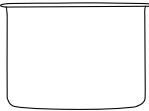
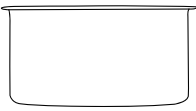
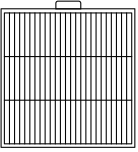

Item No.	Reference Image	Qty.	Item No.	Reference Image	Qty.
K	 18.1(D) in.	x1	L		x2
M		x1	N		x2
P	 17.7(L) in.	x1	Q	 18.1(L) in.	x1
R		x2	S		x2
T	 17.3(L)*16.5(w) in.	x1			

Parts List and Diagram

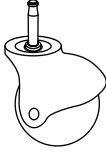
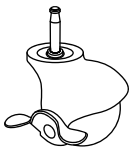
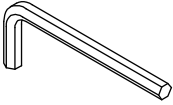

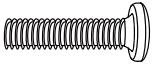
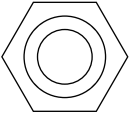
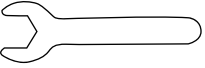
Item No.	Reference Image	Qty.	Item No.	Reference Image	Qty.
U		x2	V		x2
①		x1	②	 M6x30 mm.	x8
③	 M6x15 mm.	x8	④		x8
⑤		x1			



STEP 1 **A** x 1 pc. **B** x 1 pc. **U** x 2 pcs. **V** x 2 pcs.

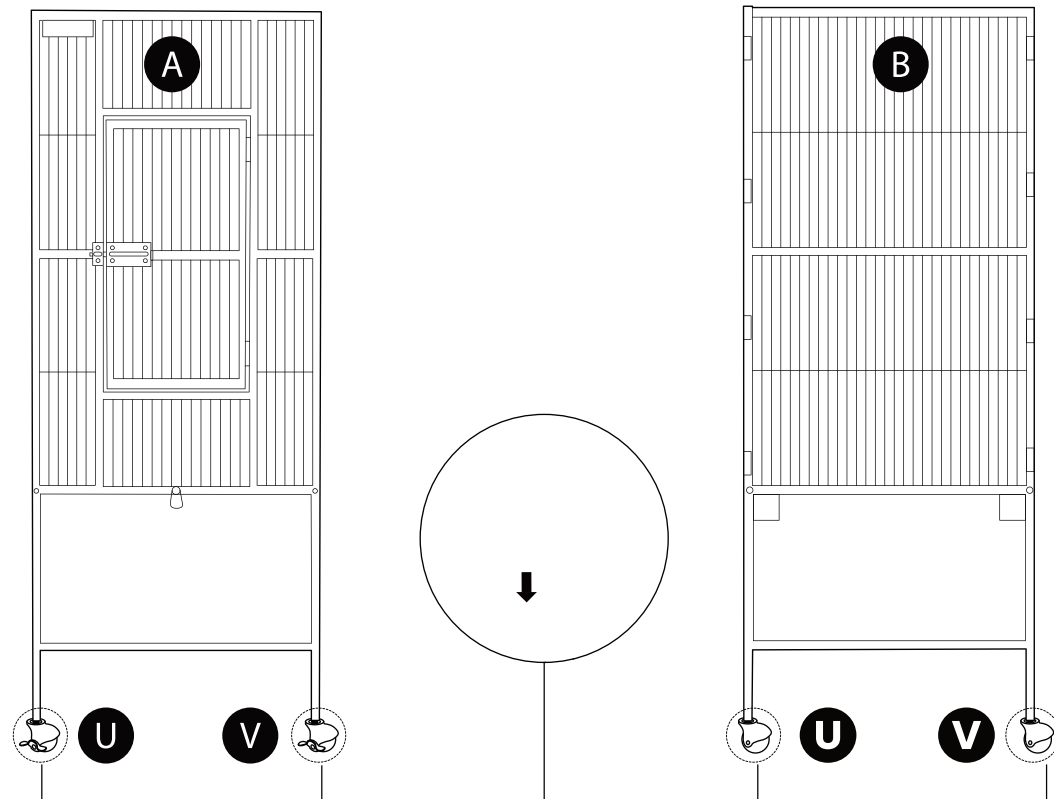

STEP 2 **E** x 2 pcs. **1** x 1 pc. **2** x 4 pcs.

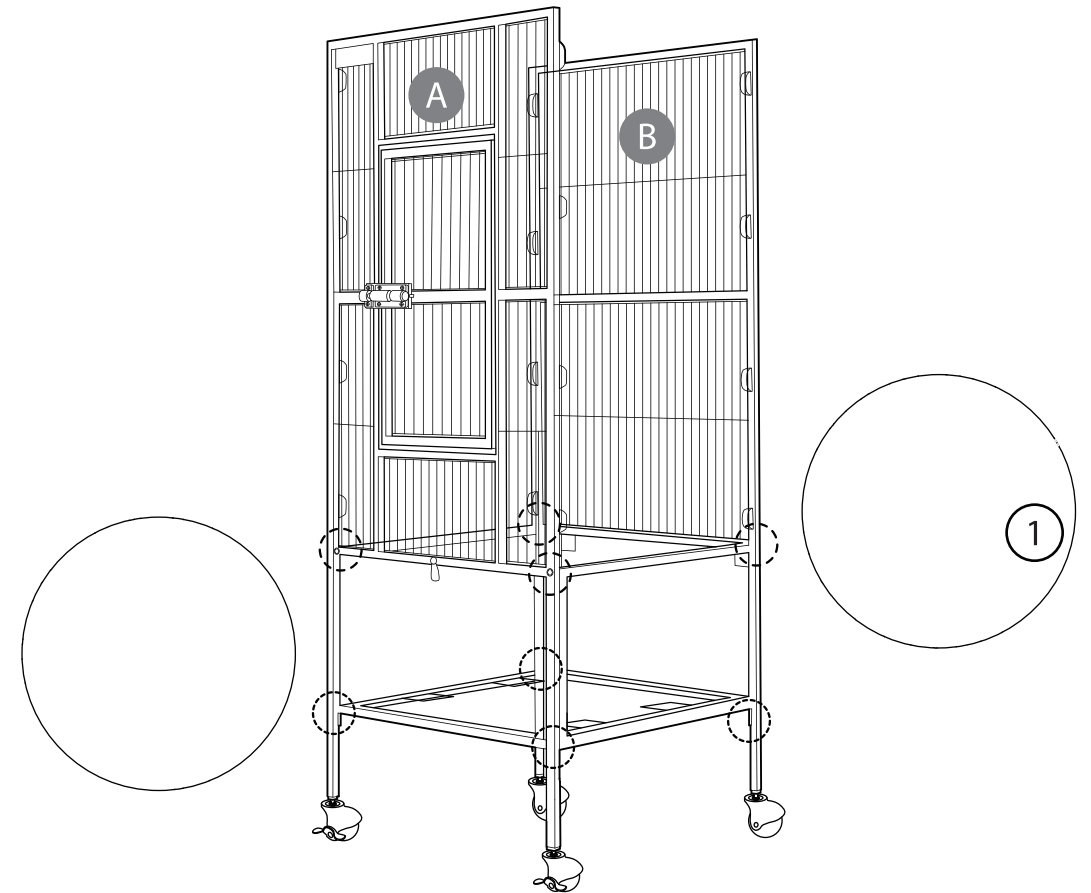



STEP 3

C x 1 pc.

D x 1 pc.

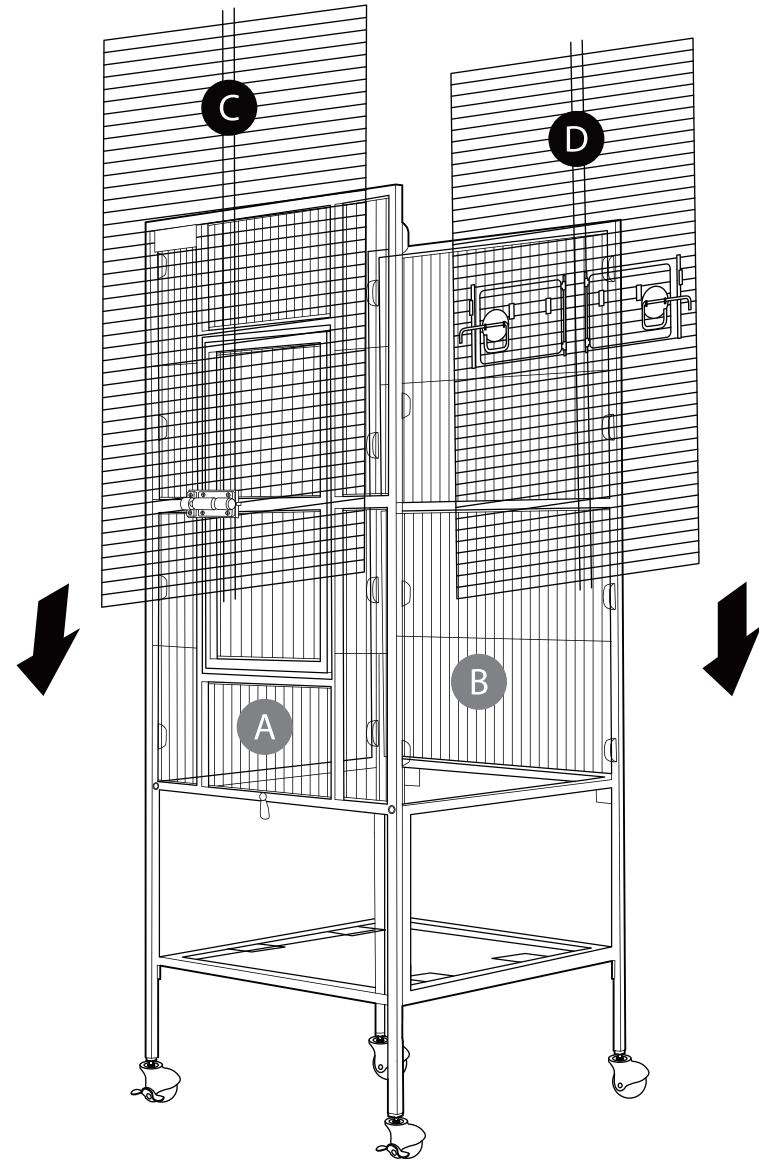

STEP 4

G x 1 pc.

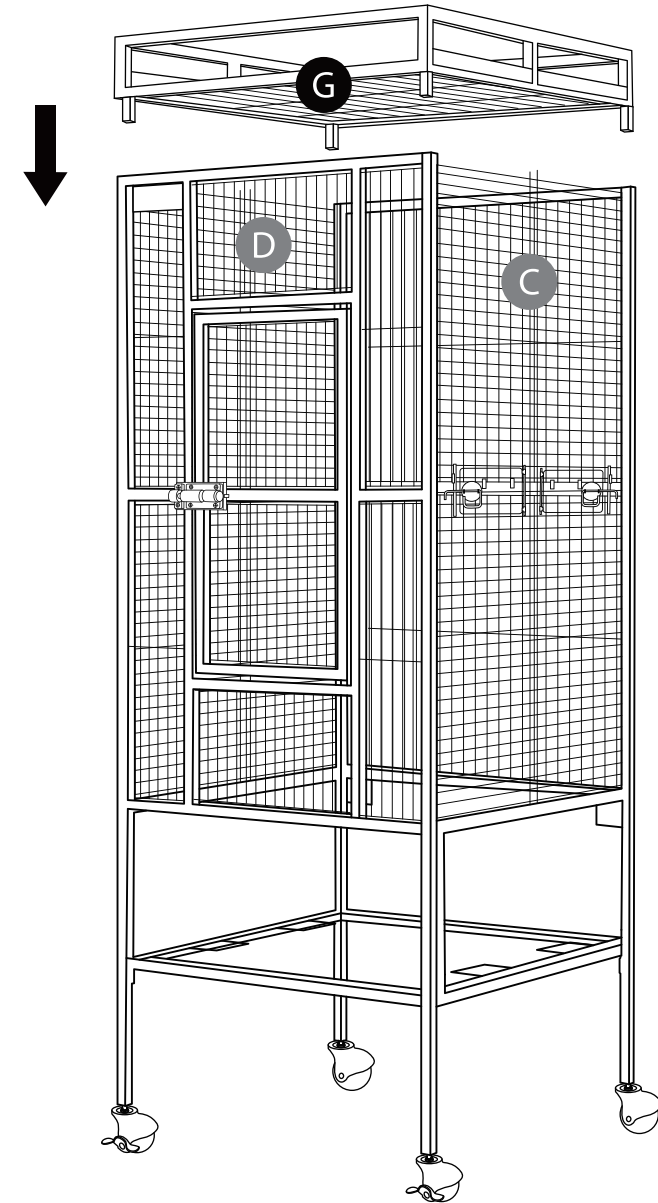



STEP 5

F x 1 pc.

M x 1 pc.

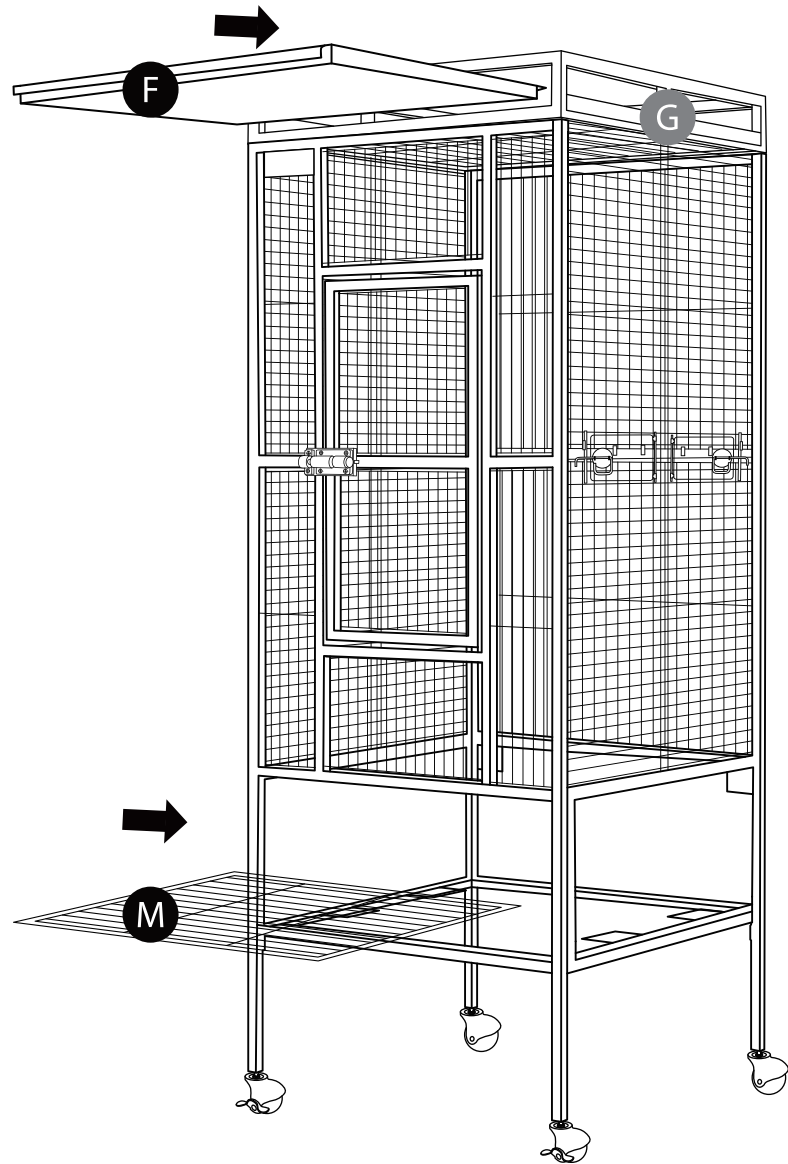

STEP 6

H x 2 pcs.

I x 2 pcs.

1 x 1 pc.

3 x 8 pcs.

4 x 8 pcs.

5 x 1 pc.

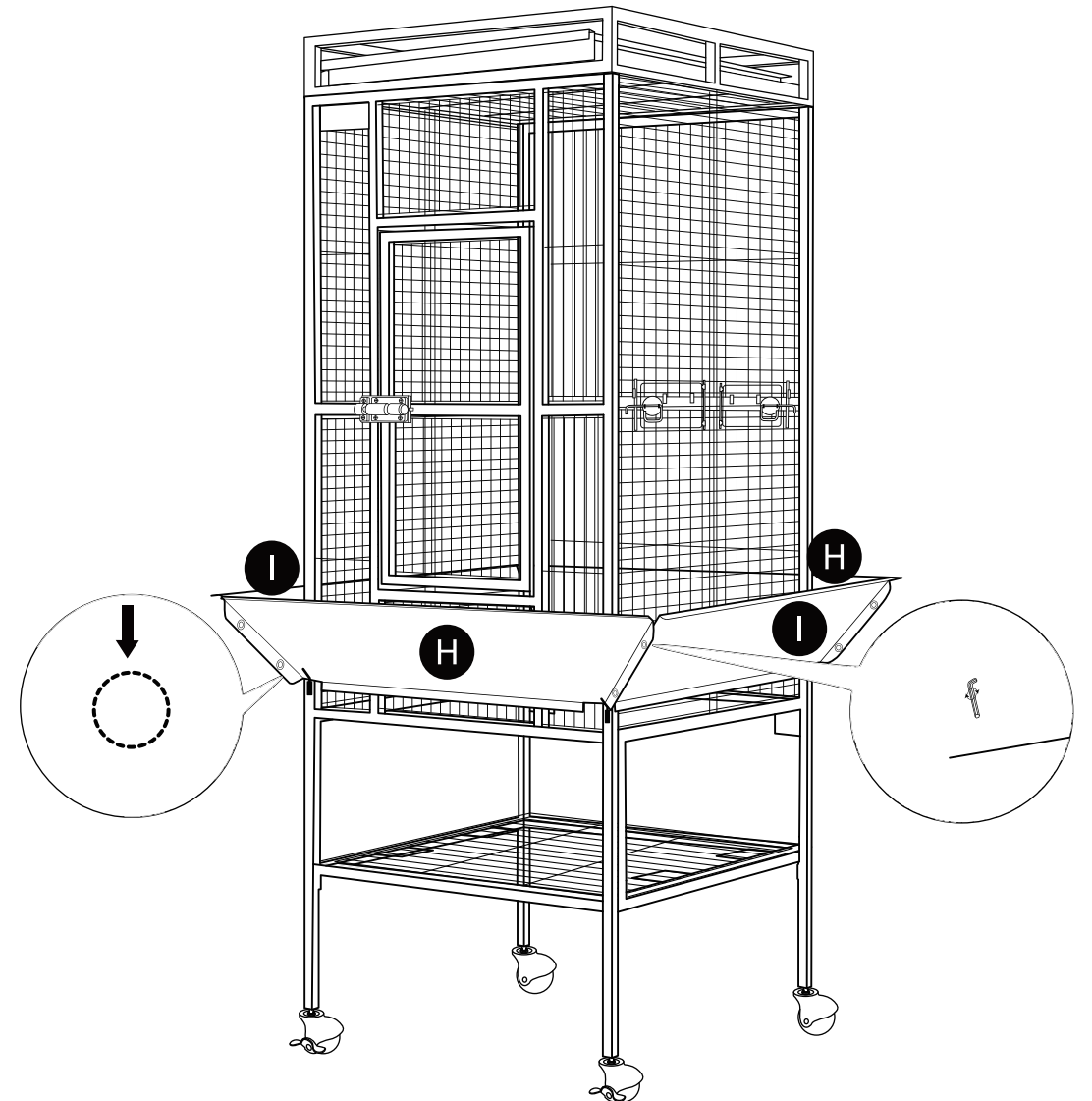



STEP 7

J x 1 pc. **K** x 1 pc. **L** x 2 pcs. **N** x 2 pcs.
1 x 1 pc. **2** x 4 pcs.

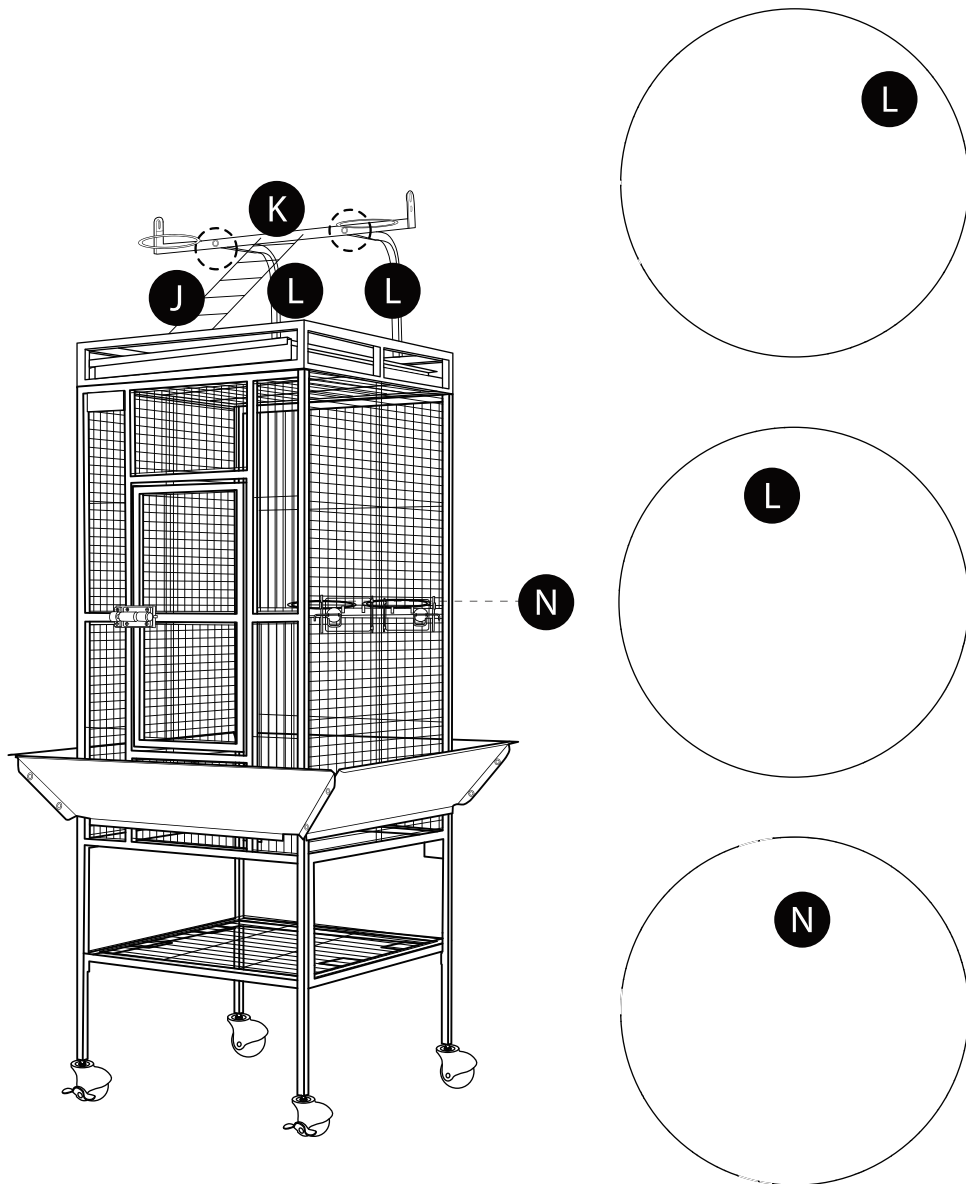

STEP 8

F x 1 pc. **P** x 1 pc. **Q** x 1 pc. **R** x 2 pcs.
S x 2 pcs. **T** x 1 pc.

