

Keeper Coat stand

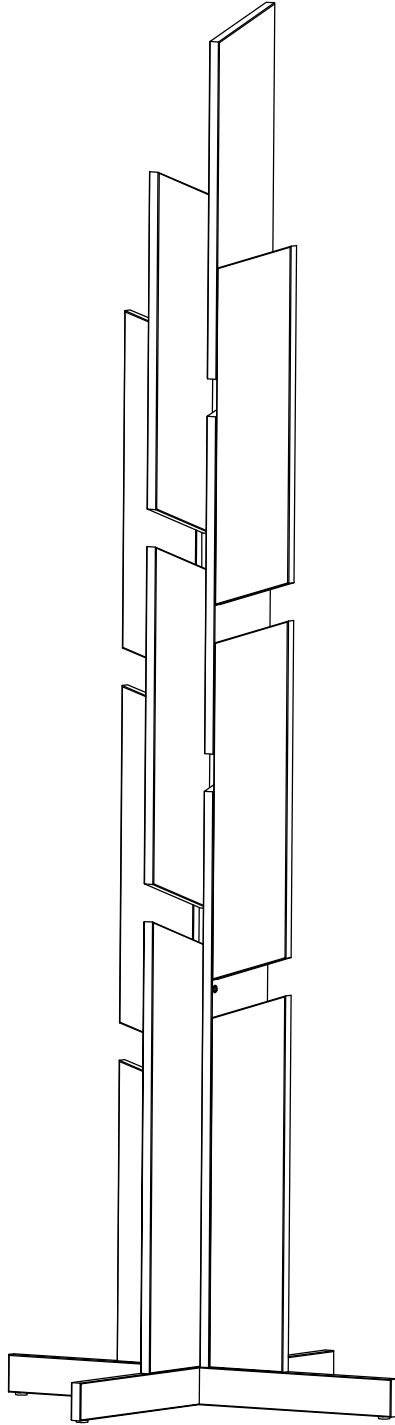

A x 20

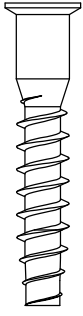

Ø7 x
40mm

B x 3

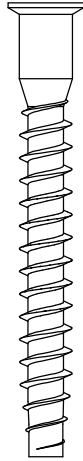

Ø7 x
60mm

C x 6

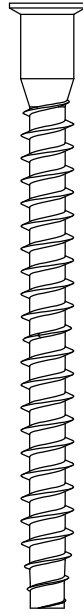

Ø7 x
80mm

D x 1

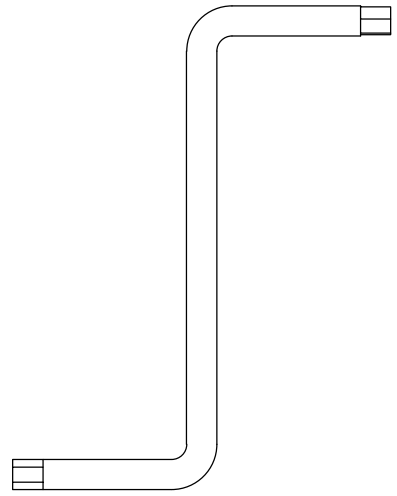

4mm

E x 4

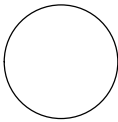

Ø15 x
3mm

F x 3

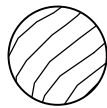

Ø13

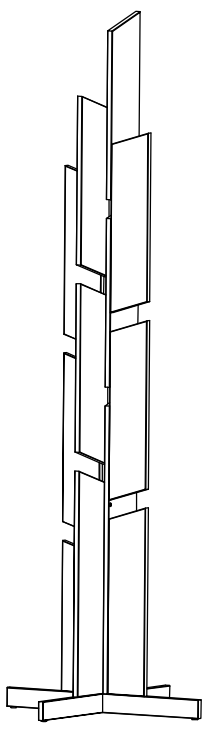

1 x ①

1 x ②

1 x ③

1 x ④

1 x ⑤

1 x ⑥

1 x ⑦

1 x ⑧

1 x ⑨

1 x ⑩

1 x ⑪

1 x ⑫

1 x ⑬

2 x ⑭

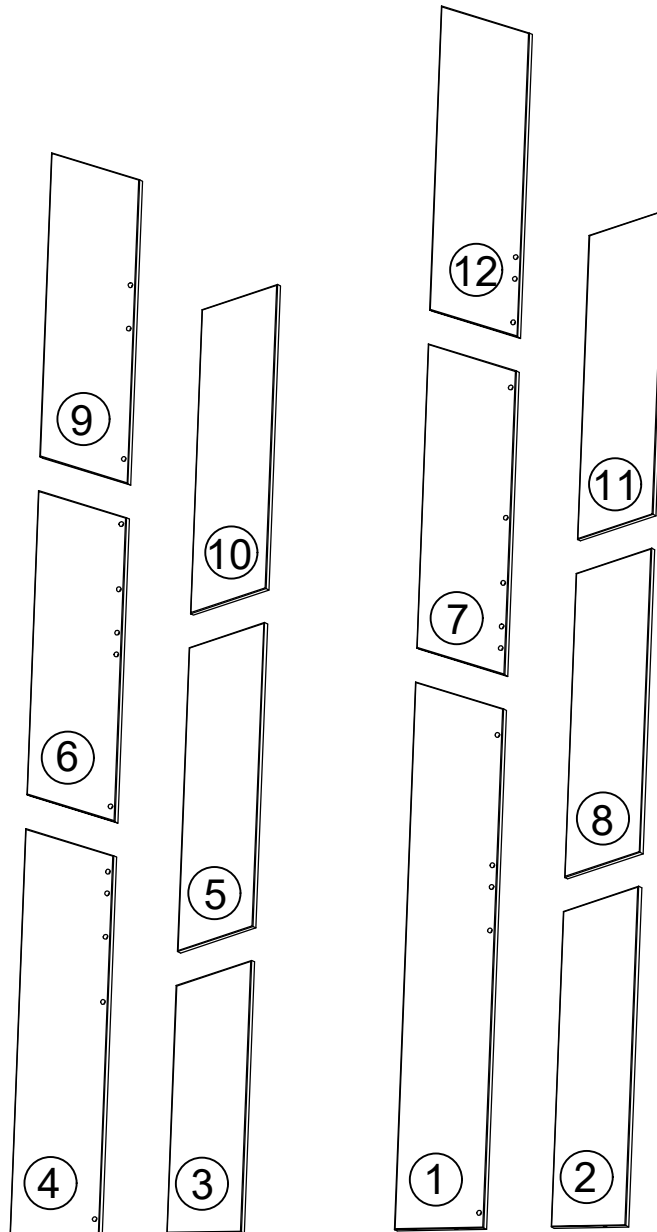

⑭

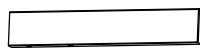
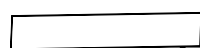

⑭

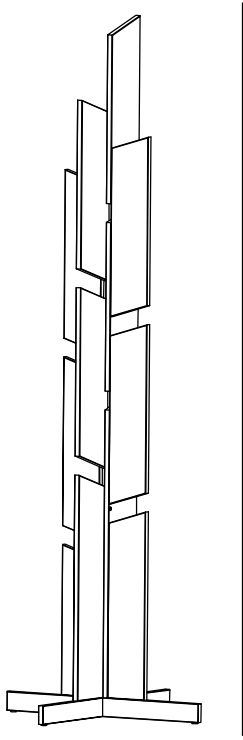

A x 10

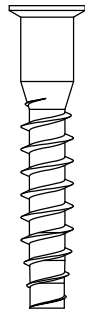

Ø7 x
40mm

D x 1

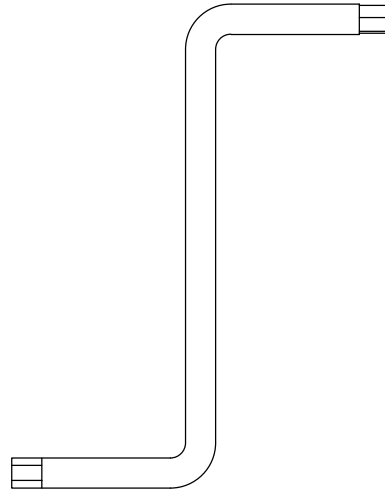

4mm

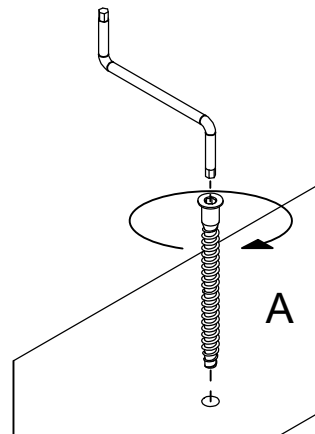
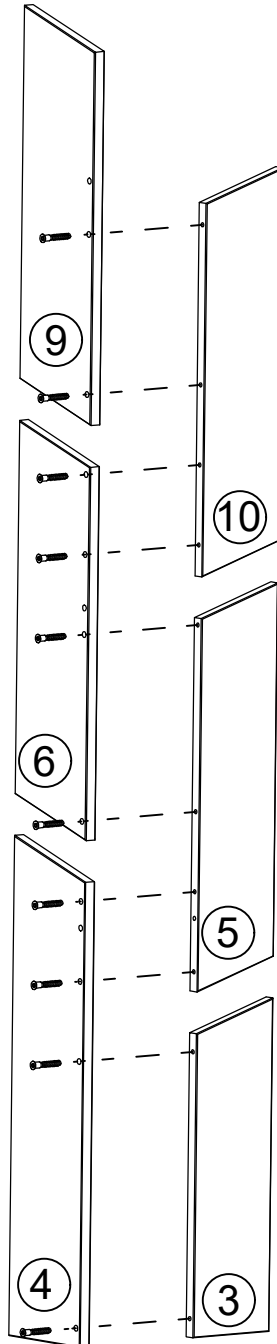

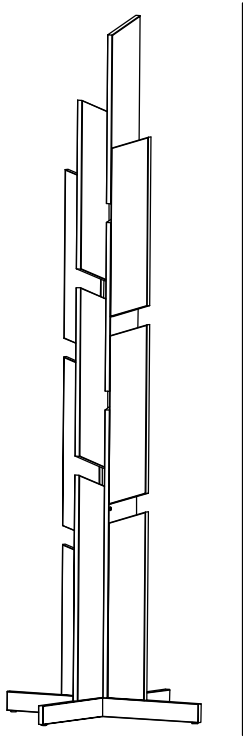

A x 10

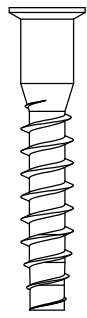

Ø7 x
40mm

D x 1

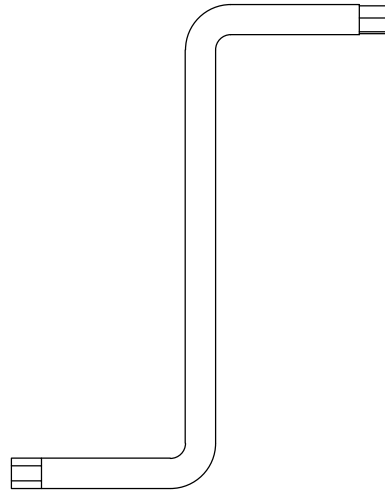

4mm

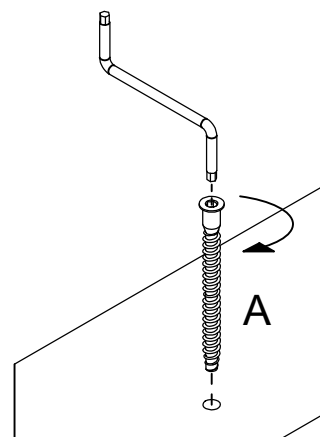
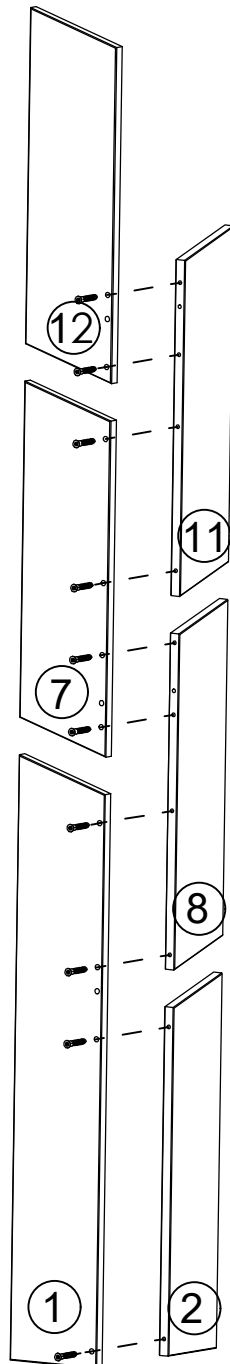

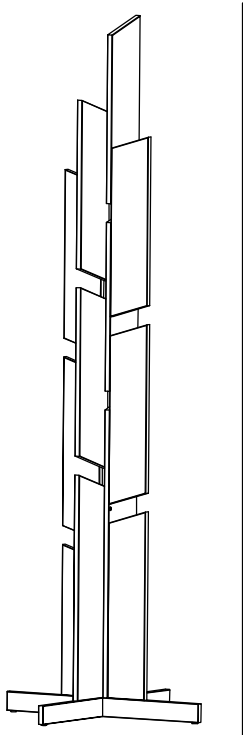

B x 3

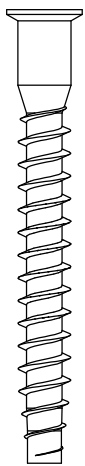

Ø7 x
60mm

D x 1

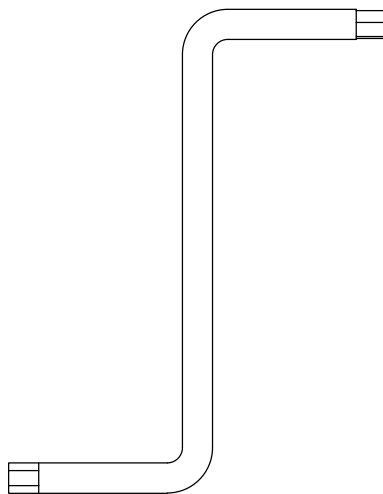

4mm

F x 3

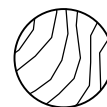

Ø13

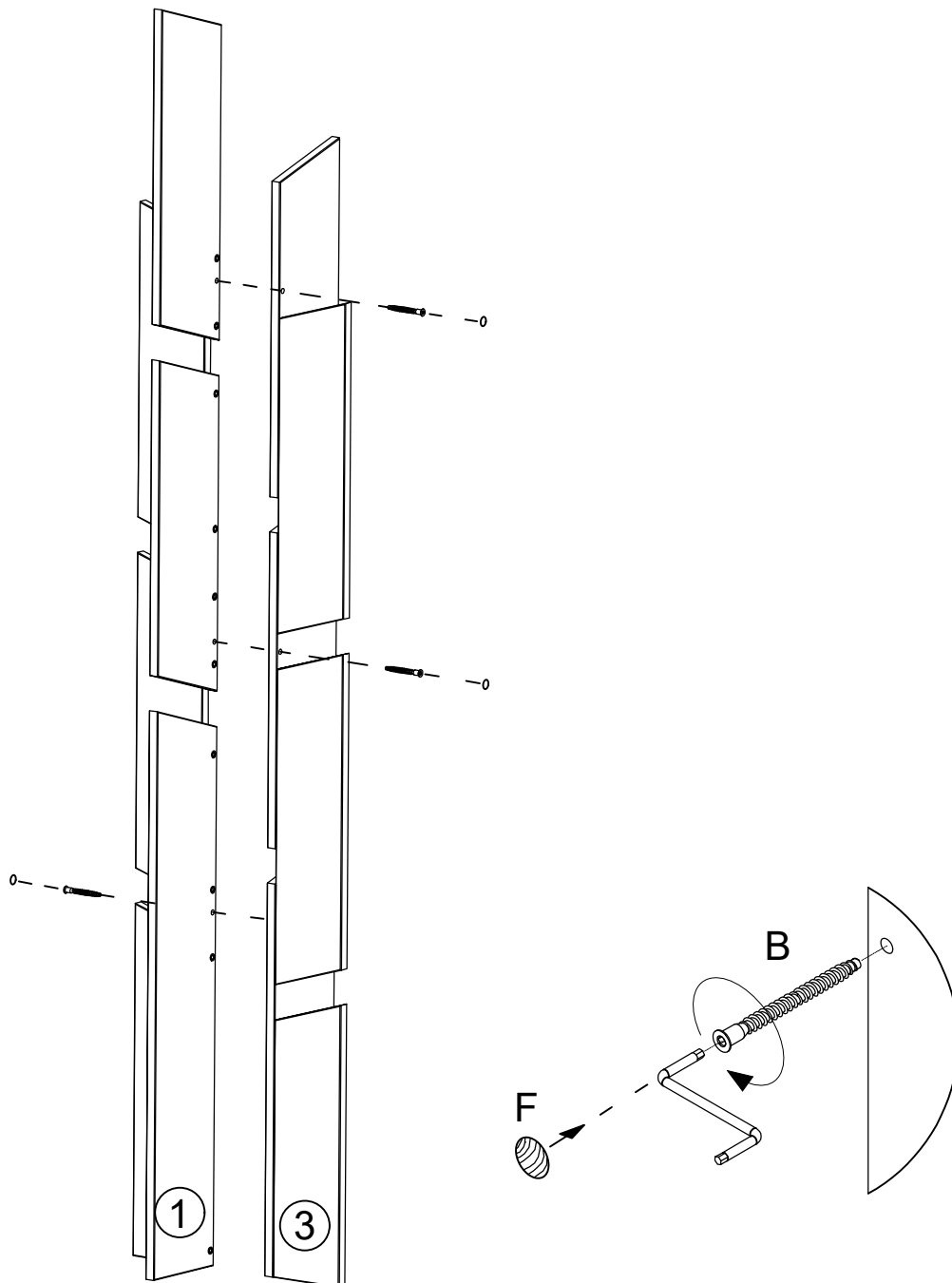

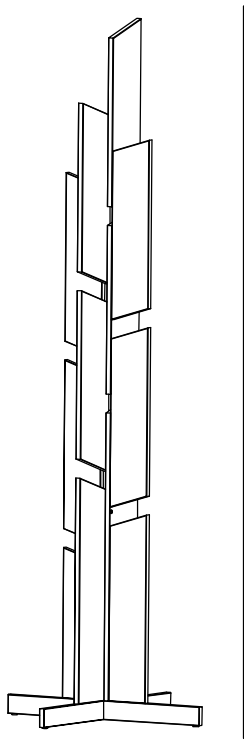

C x 6

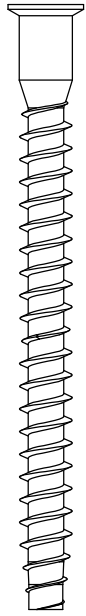

Ø7 x 80mm

D x 1

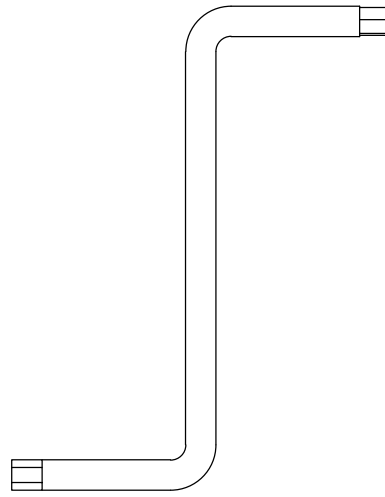

4mm

E x 4

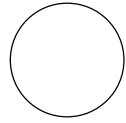

Ø15 x 3mm

