

Installation instruction







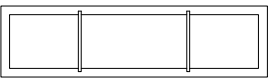

Contents

Before getting started, ensure the package contains the following components:

Antes de comenzar, asegurese de que el paquete contenga los siguientes componentes:

Avant de commencer, assurez-vous qu le paquet contient les composants suivants:

						
A	B	C	D	E	F	G
Fitter x1	Backplate x1	Mounting Screw x4	Anchor x4	Tapping Screw x4	Junction Box Screw x2	Wire Connector x3

ASSEMBLY INSTRUCTIONS:

IMPORTANT: Turn off the power at the main fuse or circuit breaker box before starting installation.

Notes: This fixtures can hang up and down to the wall.

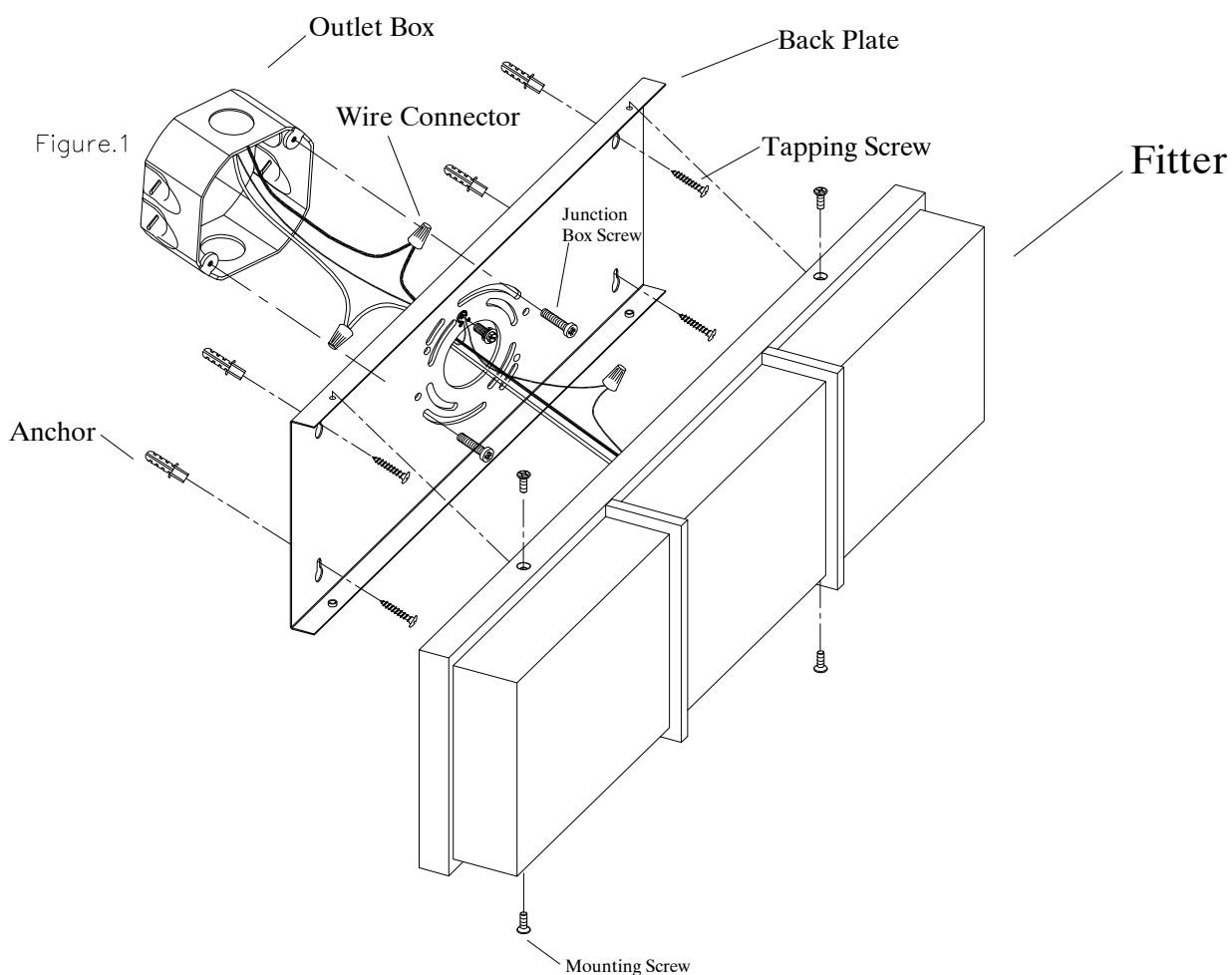

Installation instruction continued on next page

Installation instruction continued

STEP 1: Pull the power supply wires from the Outlet Box ,and strip 3/4in. of insulation from wire ends for each wire. Twist stripped ends of supply wires and fitter together with pliers, black to black(Live) and white to white(neutral). Attach copper wire of fitter to the ground wire of supply.

Notes:if installation is without Outlet Box,first put the Backplate onto the Conduit and fix it prior to wiring.

Helpful hint: if necessary,attach copper ground wire to grounded junction box.

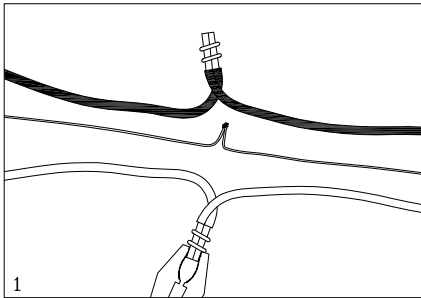

STEP 2: Attach wire connectors(G) to the wires. Tape wire connectors and wires together.

STEP 3: Push connections and splices into Outlet box .

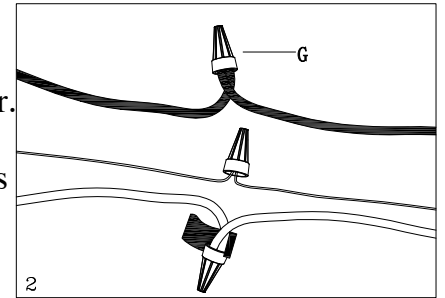

STEP 4: Mount the Backplate (B) to the Outlet Box and the wall by Junction Box Screws(F) and Tapping Screws(E) with Anchors(D)(Refer to previous page Figure.1)

STEP 5: Place the Fitter(A) over the Backplate(B) by 4pcs Mountion Screws(C) (Refer to previous page Figure.1).

