

Coffee Store Playset

(WG388)



98.1WG388.150

Assembly Instruction

Please follow this instruction to avoid assembly errors.







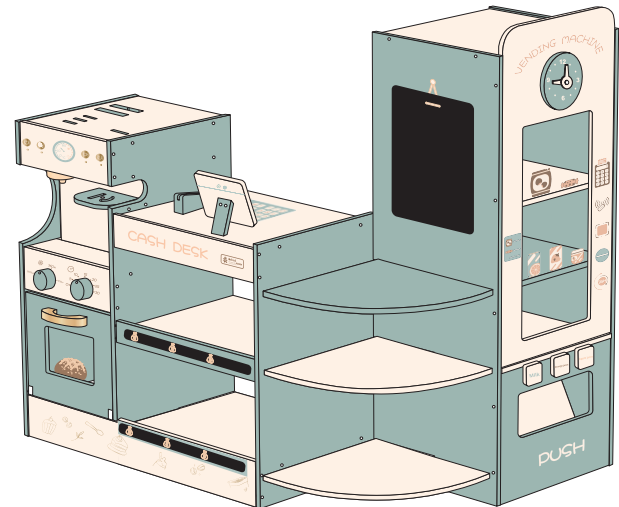



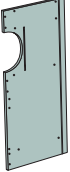
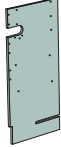

For customer service, please contact *E-mail:shop@robud.com*

WARNING:

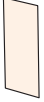
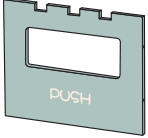

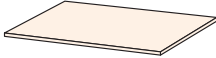

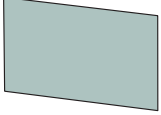

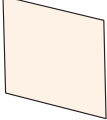
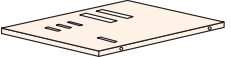

- CHOKING HAZARD-Small parts.Not suitable for children under 3 years.
- Toys intended to be assembled by an adult. Children should use the product under adult's guidance.
- After opening the package,please keep the packaging items such as plastic film or bags away from babies and children to avoid danger of suffocation.
- Please keep the product away from fire, substances flammable and humid environments to prevent damage.
- Please keep the product away from water, and don't put liquid in the toy sets.
- Please clean the product with dry soft cloth, don't clean this product with chemical cleaners: alcohol, ammonia water, glass cleaner, etc.
- The instruction must be retained since it contains important information.

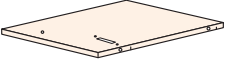
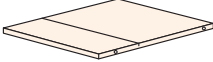
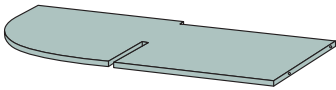
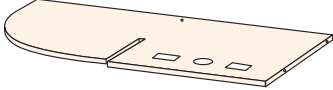
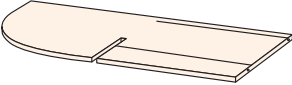
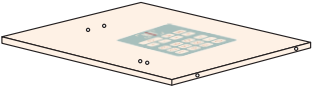
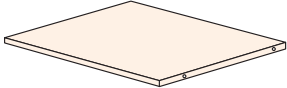
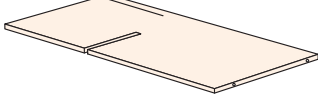

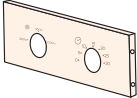

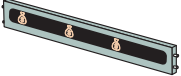
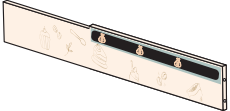





Product Parts

1 	2 	3 	4 
x1	x1	x1	x1
5 	6 	7 	8 
x1	x1	x1	x1
9 	10 	11 	12 
x1	x1	x1	x1
13 	14 	15 	16 
x1	x1	x1	x1







Product Parts

 <p>17</p>	 <p>18</p>	 <p>19</p>	 <p>20</p>
x1	x1	x1	x1
 <p>21</p>	 <p>22</p>	 <p>23</p>	 <p>24</p>
x1	x1	x1	x1
 <p>25</p>	 <p>26</p>	 <p>27</p>	 <p>28</p>
x1	x1	x1	x1
 <p>29</p>	 <p>30</p>	 <p>31</p>	 <p>32</p>
x1	x1	x1	x1







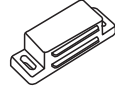







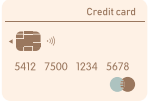

Product Parts

<p>33</p> 	<p>34</p> 	<p>35</p> 	<p>36</p> 
<p>x1</p>	<p>x1</p>	<p>x1</p>	<p>x1</p>
<p>37</p> 	<p>38</p> 	<p>39</p> 	<p>40</p> 
<p>x2</p>	<p>x2</p>	<p>x1</p>	<p>x1</p>







Hardware

<p>41</p>  <p>4x25</p>	<p>42</p>  <p>4x14</p>	<p>43</p>  <p>4x10</p>   <p>a b</p>	<p>44</p>  <p>3x10</p> 
<p>x73</p>	<p>x4</p>	<p>x4</p> <p>x2</p>	<p>x6</p> <p>x3</p>

Accessories

<p>45</p>  <p>3x8</p>	<p>46</p>  <p>4x20</p>		
<p>x6</p>	<p>x3</p>	<p>x4</p>	<p>x2</p>
			
<p>x2</p>	<p>x1</p>	<p>x1</p>	<p>x1</p>
			
<p>x1</p>	<p>x6</p>	<p>x1</p>	<p>x1</p>
			
<p>x1</p>	<p>x1</p>	<p>x1</p>	<p>x1</p>

Accessories

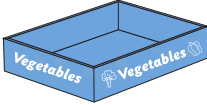
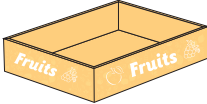
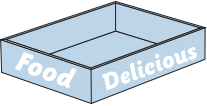
			
x1	x1	x1	x1
			
x1	x1	x1	x1
			
x1			

Assembly Instruction

1

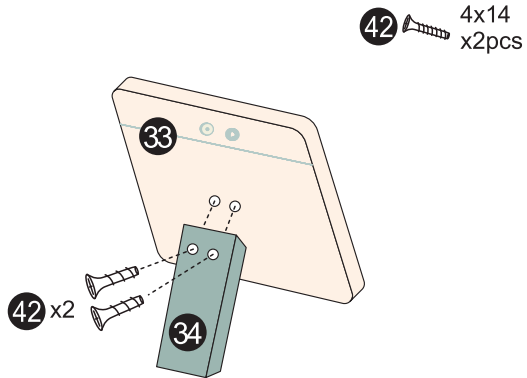

2

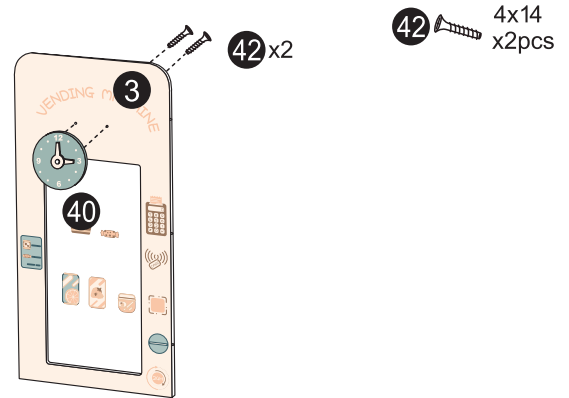

3

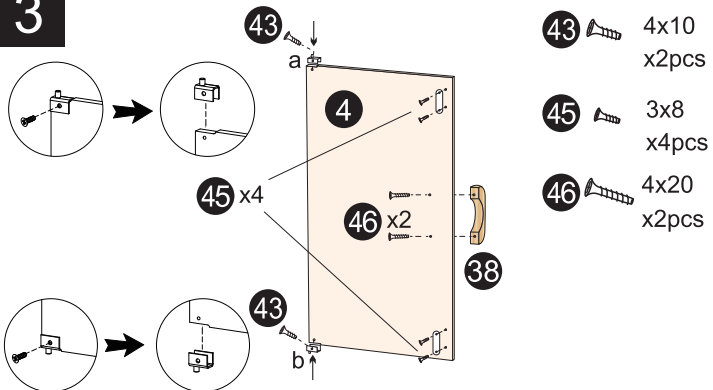

4

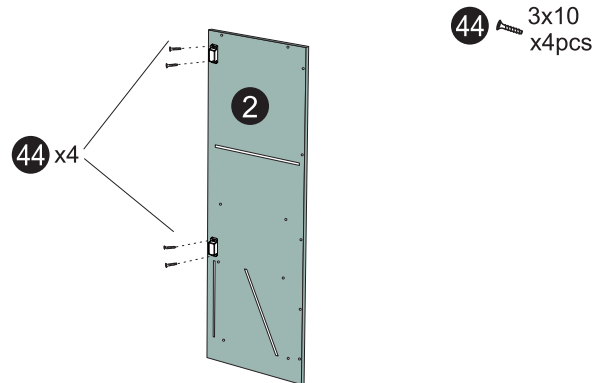

Assembly Instruction

5

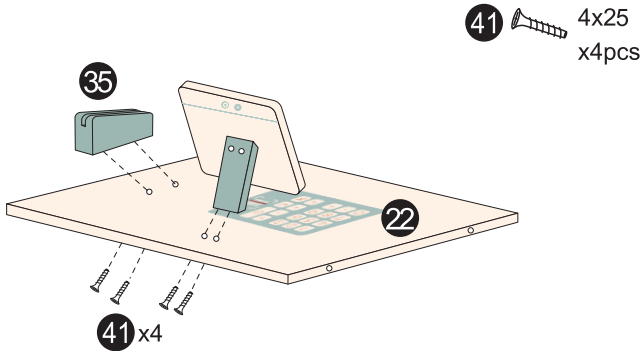

6

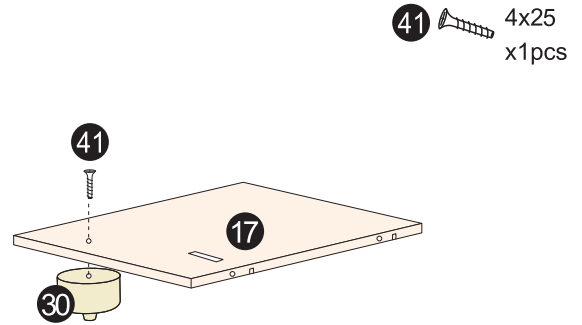

7

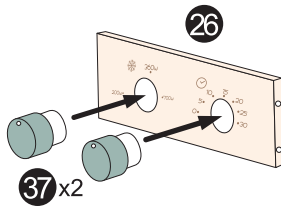

8

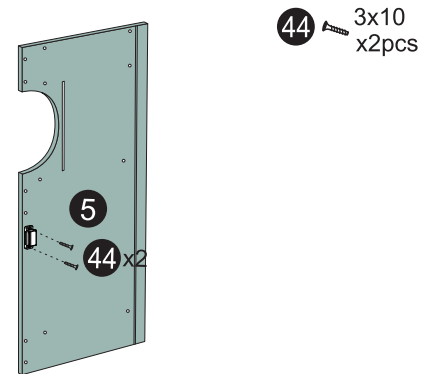

Assembly Instruction

9

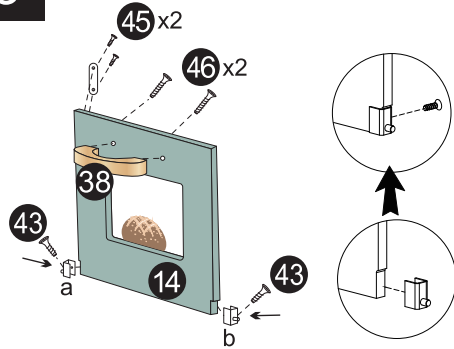

- 43 4x10 x2pcs
- 45 3x8 x2pcs
- 46 4x20 x2pcs

10

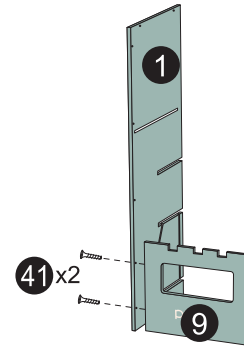

- 41 4x25 x2pcs

11

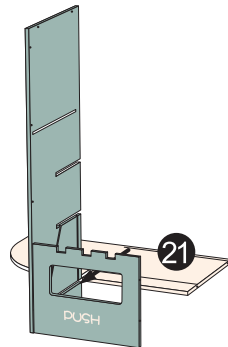

12

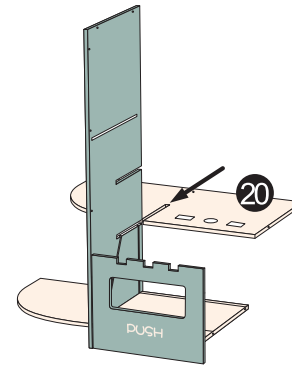

Assembly Instruction

13

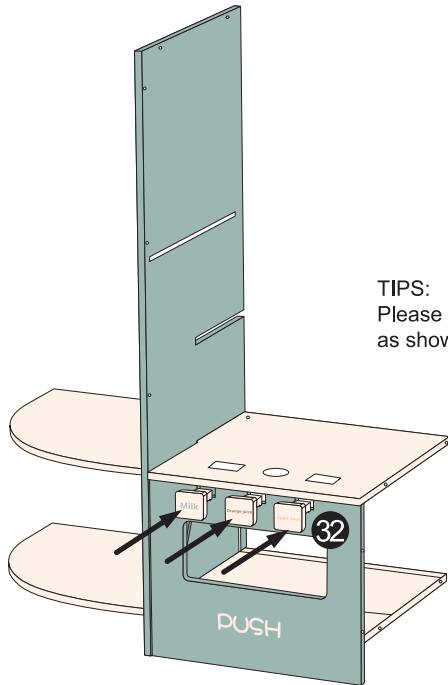

TIPS:
Please assemble the buttons
as shown sequence.

14

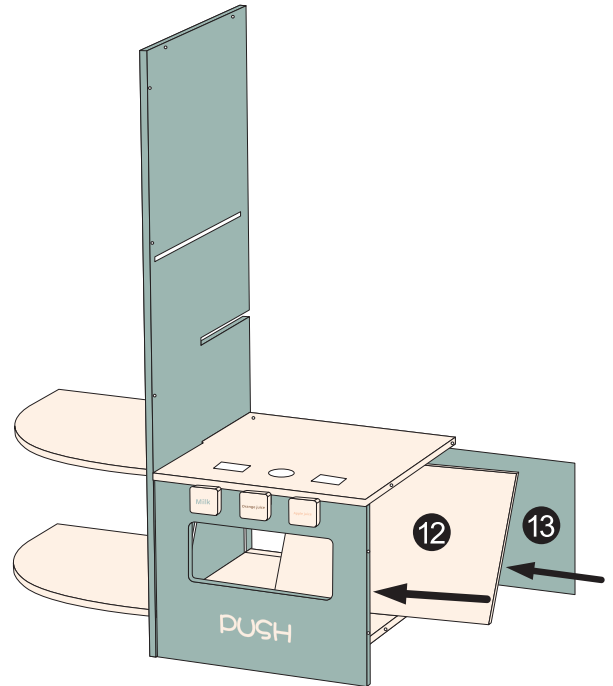

Assembly Instruction

15

41 4x25
x6pcs

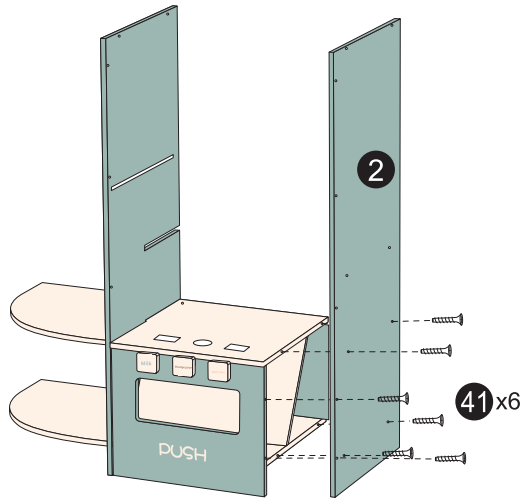

16

41 4x25
x2pcs

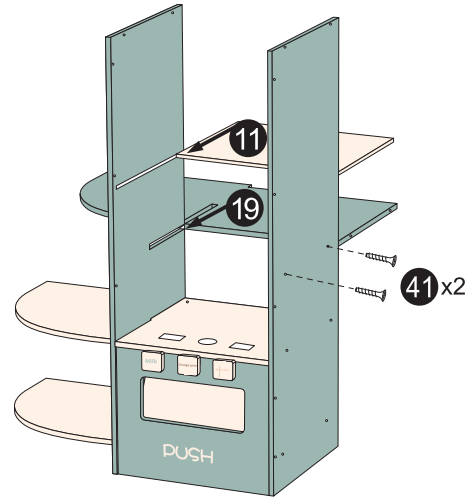

Assembly Instruction

17

41  4x25
x6pcs

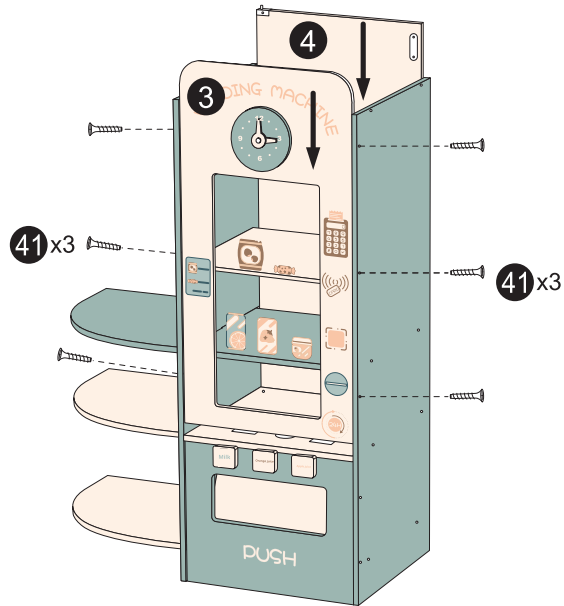

18

41  4x25
x4pcs

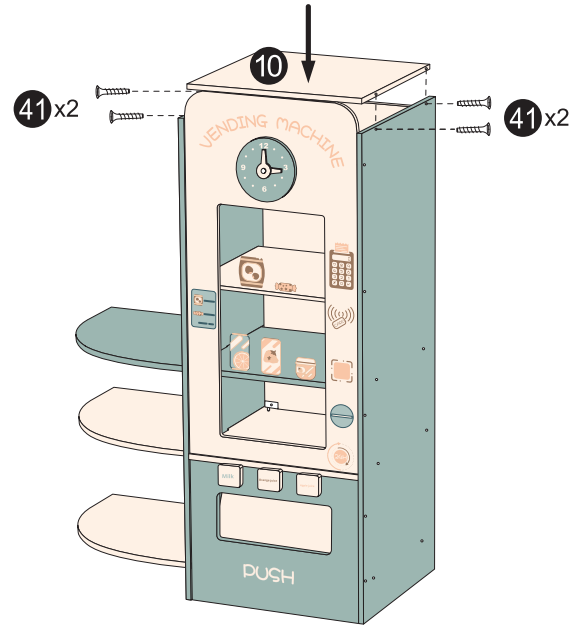

Assembly Instruction

19

41  4x25
x6pcs

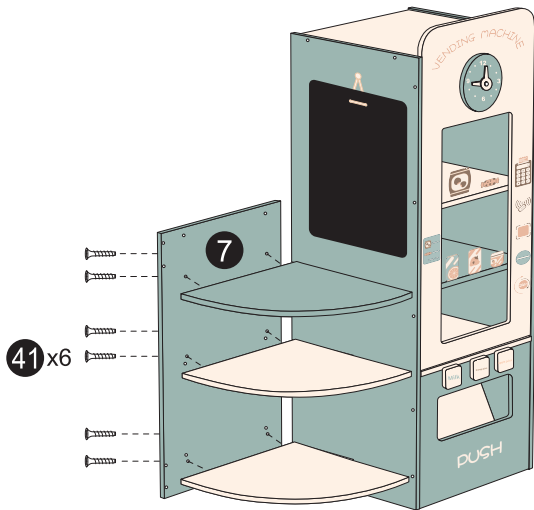

20

41  4x25
x2pcs

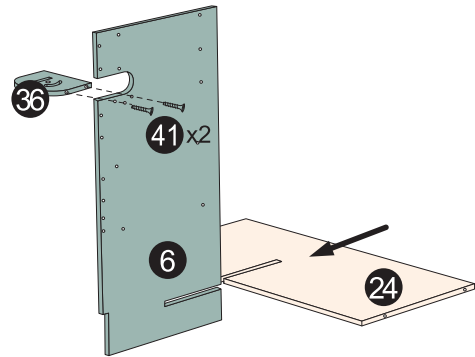

Assembly Instruction

21

41  4x25
x6pcs

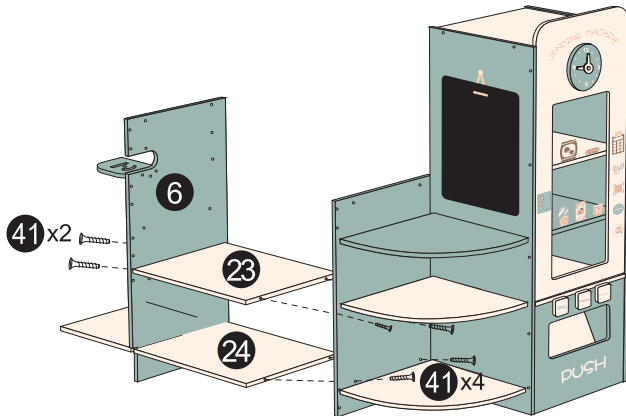

22

41  4x25
x4pcs

TIPS:
Please assemble Board 28 firstly,
then proceed to other steps.

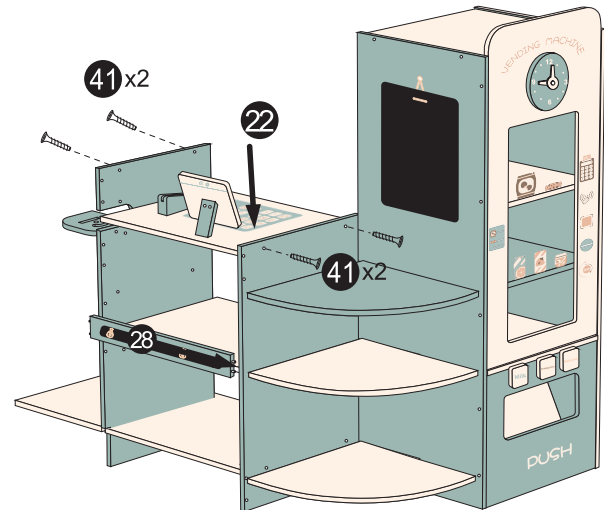

Assembly Instruction

23

41  4x25
x6pcs

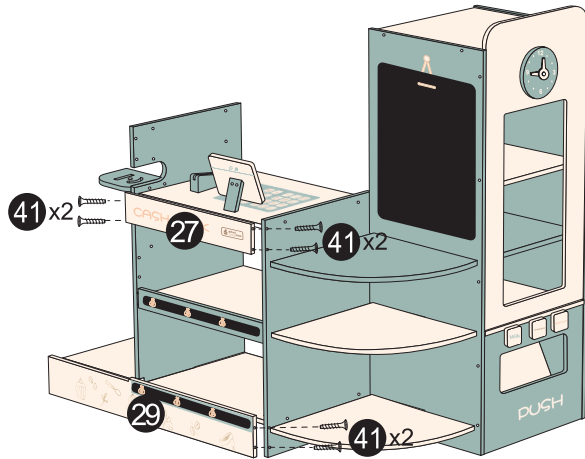

24

41  4x25
x4pcs

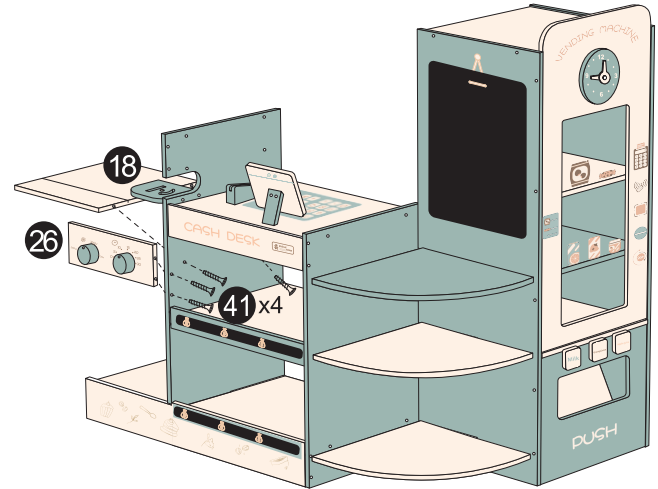

Assembly Instruction

25

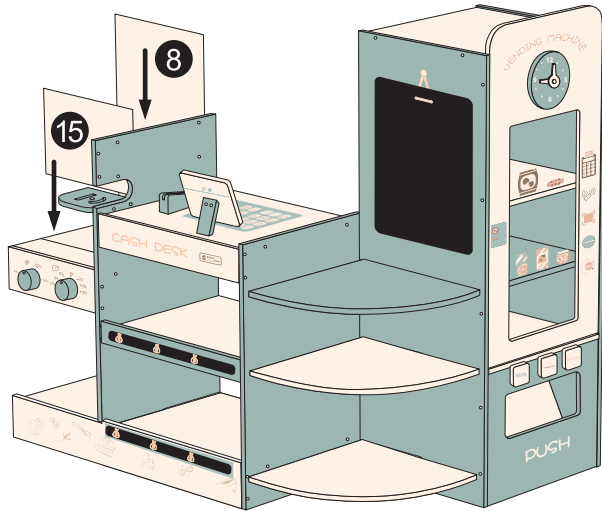

26

41  4x25
x2pcs

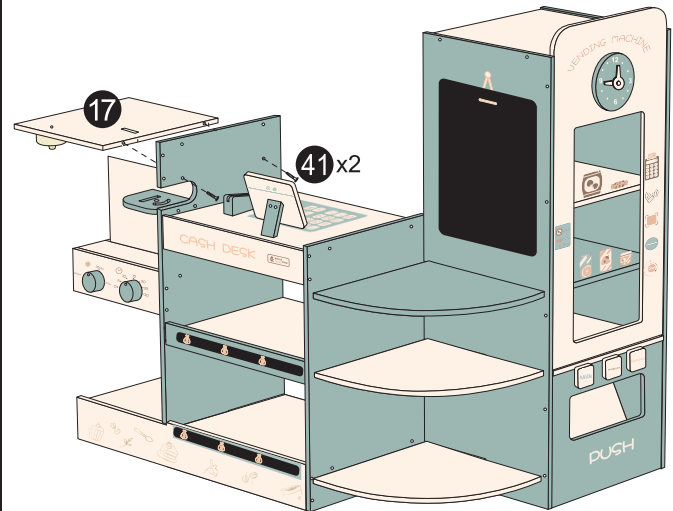

Assembly Instruction

27

41  4x25
x2pcs

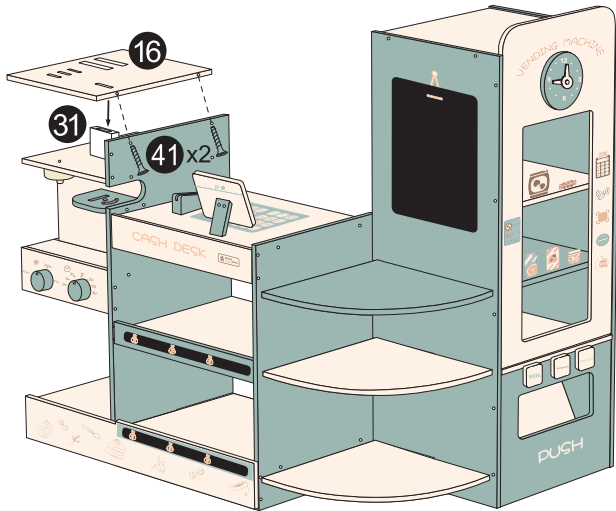

28

41  4x25
x2pcs

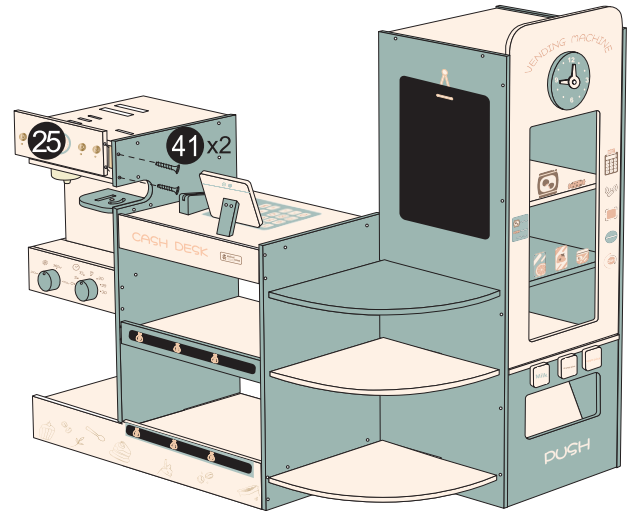

Assembly Instruction

29

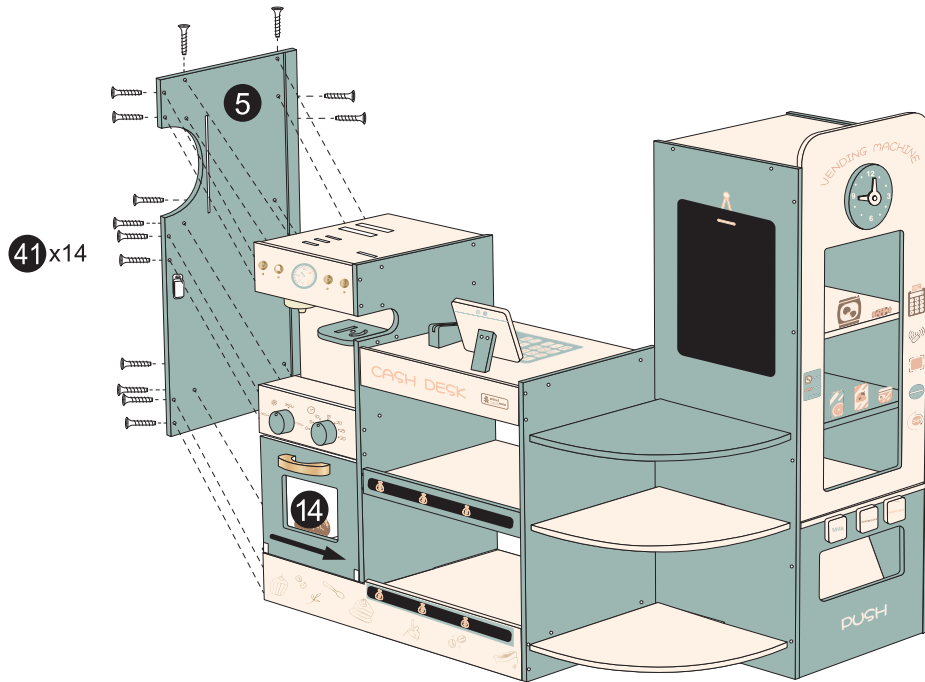

41 4x25
x14pcs

Assembly Instruction

30

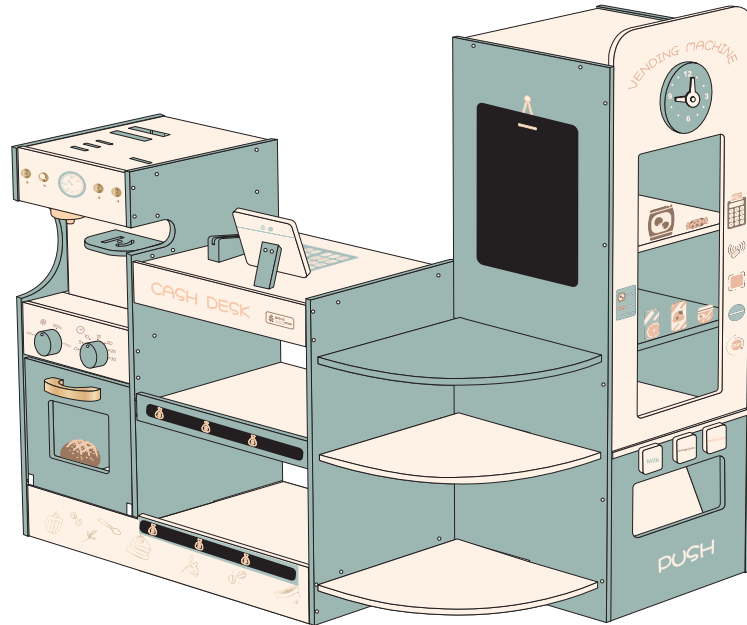

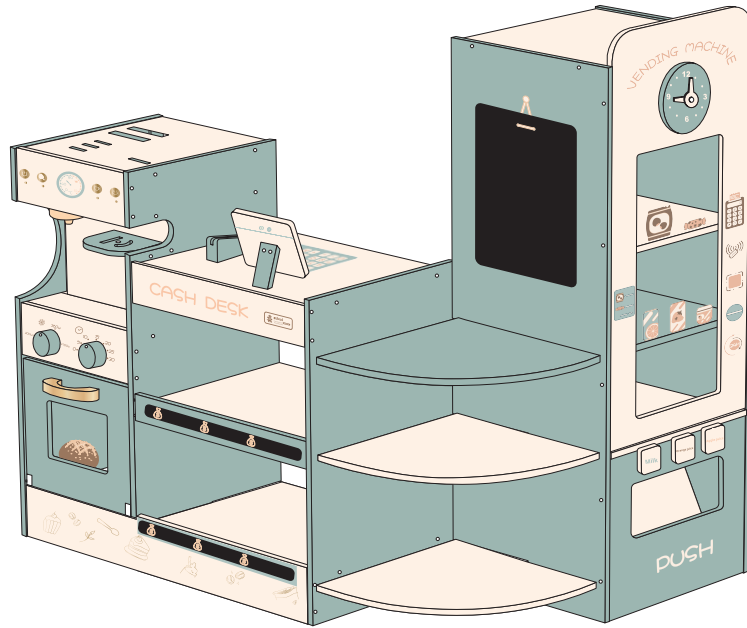

robud

www.robud.com