

CARE AND MAINTENANCE

Always use felt pads under all articles to prevent discoloration or softening of the lacquer. Plastic and rubber bases on items can discolor wood. Wipe up spills immediately and avoid common hazards such as hot dishes, harsh solvents and abrasives. Cleaning should be done with a soft lint free cotton cloth dampened with water or furniture polish. On highly used surfaces we recommend applying a quality paste wax which should be used on a regular basis to provide additional protection from scratches and spills. How often you apply the wax depends on how much wear the furniture receives.



NOTICE

* Please make sure that you have all parts indicated before you begin assembly of this item

* This item should be assembled on a soft surface to prevent scratching the finish during assembly

* This item may require periodic tightening

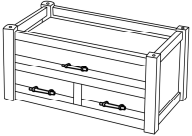
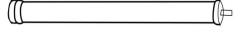
Part List

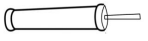
PIECE	DESCRIPTION	PICTURE	QUANTITY
A	Table Top		1X
B	Leg		4X
C	Bottom Board		1X
D	Foot		4X

Product Dimensions: 23.5"W x 13"D x 29.5"H

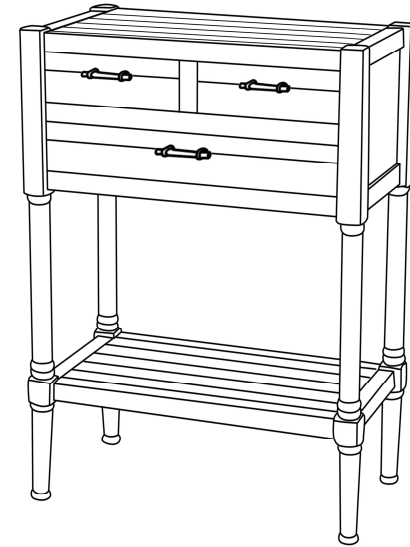

PREPARATION

Before beginning assembly of product, make sure all parts are present. Compare parts with package contents list
If any part is missing or damaged, do not attempt to assemble the product.
Estimated Assembly Time: 5 minutes.

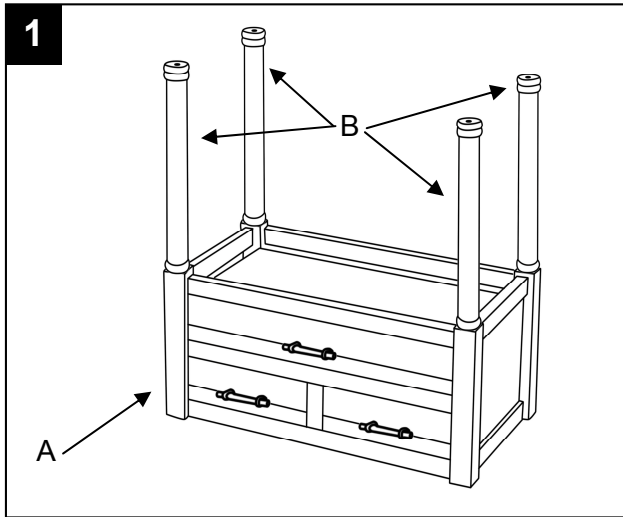

Step 1

Take all packaging off the table. Screw four legs to the table top and gently tighten the legs.

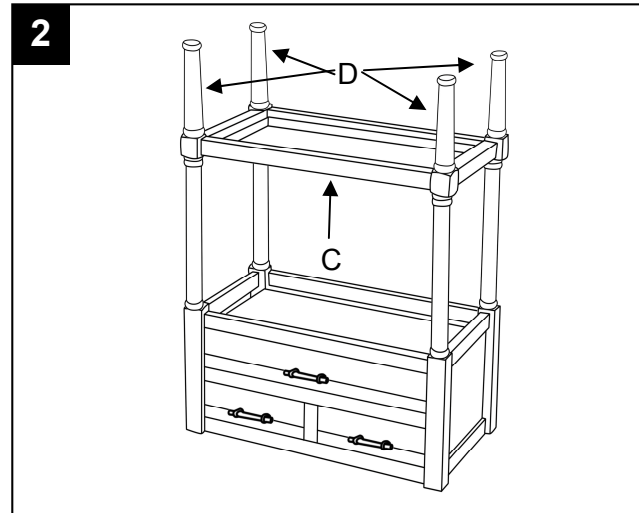

Step 2

Put the bottom board over the end of four legs, Screw four feet through bottom board to connect with legs.



Step 3

Turn the table up to right side, assembling process done.