

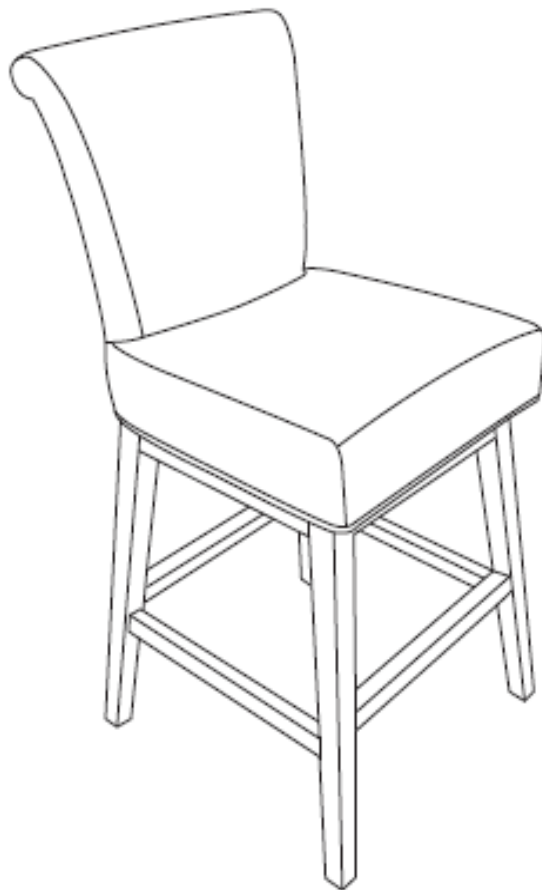

Assembly Instructions

CAUTION : You must read this before you proceed



BARSTOOL

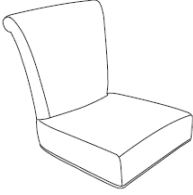

Parts List

Label	Picture	Description	QTY
A		SEAT	1
B		FRAME	1

Hardware

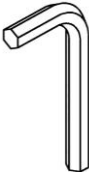
Label	Picture	Description	QTY
1		Dia. M6 Bolt: 40 mm(L)	5
2		Flat Washer Ring	5
3		Spring Washer Ring	5
4		Allen Key	1

Assembly Preparation

Before Beginning Assembly:

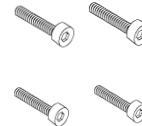
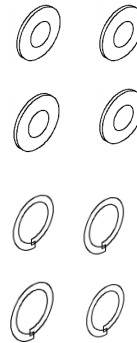
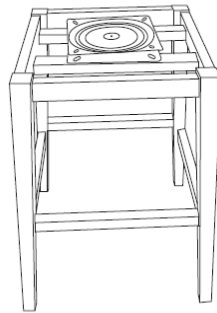
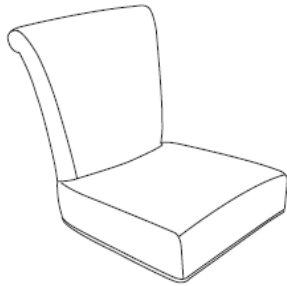

- Read instructions, cover to cover-



- Have 2 adults on hand for assembly-



- Do not assemble on flooring or carpet-



- Assemble on a clean non-marring surface (packing foam)-



- Save all packaging until finished-

Assembly Steps

Parts Introduction

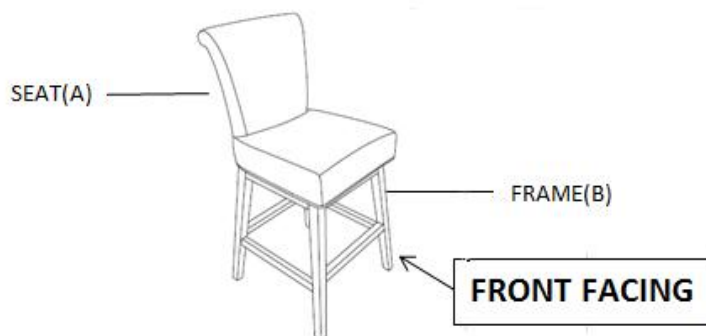

This barstool has multiple parts and may require up to some 6 minutes to assemble. To give you an overview of the barstool parts, the above picture is to help you put the various parts into perspective. Please read through the instructions herebelow to familiarise the parts and steps before assembly.

Step 1



Caution: During the assembly process, DO NOT place finger into gap of the Chair Seat and the Chair Leg Frame.

Step 2

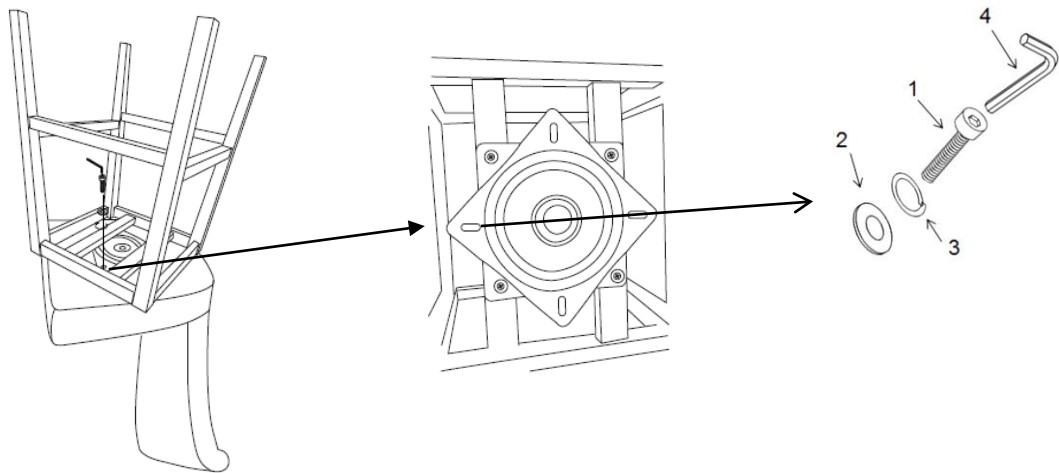

Put the seat upside down and lay on a protective carpet.
Then turn the Swivel Plate some 45° degrees to the position as above show.
Align the bolt holes on the Swivel Plate to the holes on the Chair Seat.
Then take the frame onto the seat swivel, and lock the four Bolts into the Swivel holes, and tighten the four bolts to connect seat and frame.

Step 3

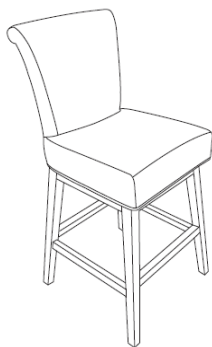

Make sure all parts are connected and securely locked into position.
Turn and stand up the barstool.
Your Barstool is ready for use.

Care & Maintenance



- Do not put hot items directly on furniture surface



- Do not clean furniture with harsh cleansers or polish.



- Do not place furniture under direct sunlight.



- Do not place furniture near heating or cooling vents.



- Do not write on furniture without a padded barrier to protect the surface.



- Do not place furniture outside . For indoor use only .



- Not for commercial use. For residential use only .



- Stains may be removed with mild soap solution and damp cloth.



- Children should not climb or jump on the furniture.



- Dust and pick-up spills using a clean, non-colored, lint-free cloth .