

Top View

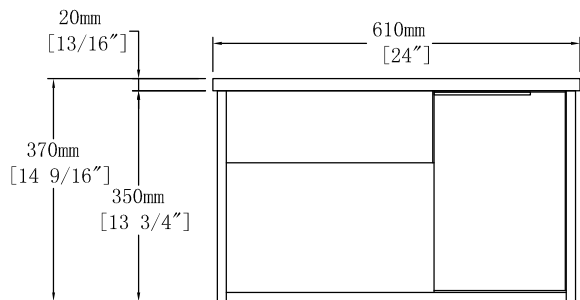

Front View

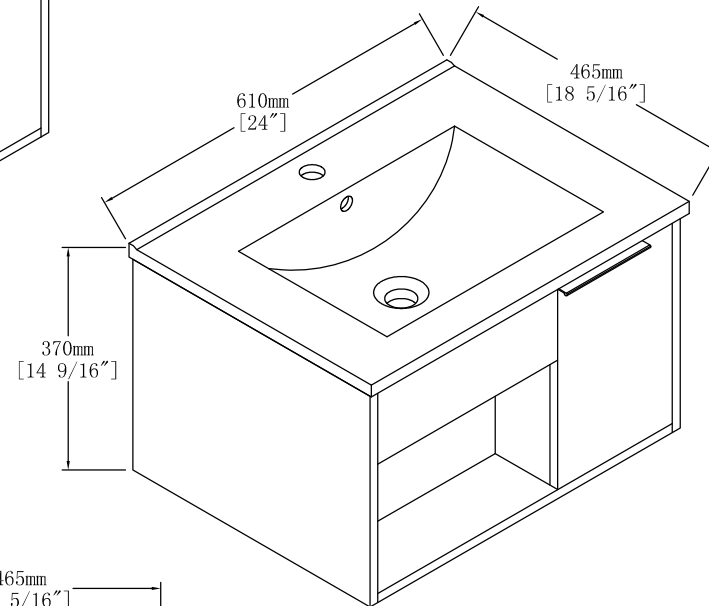
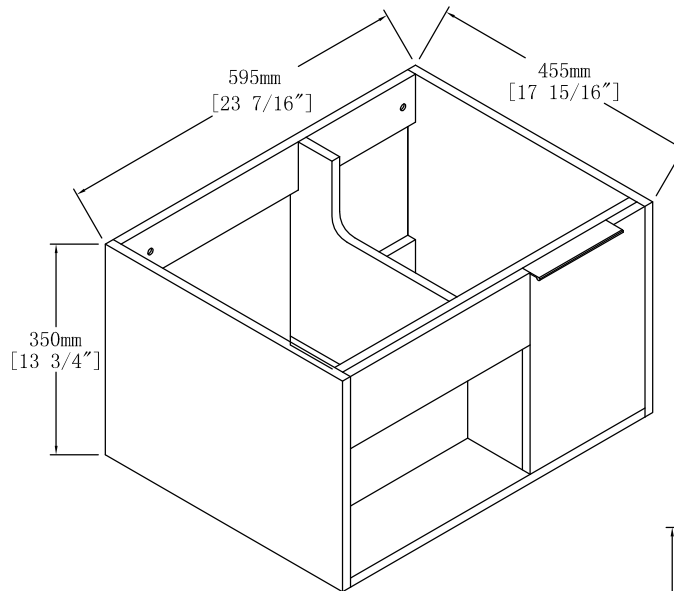
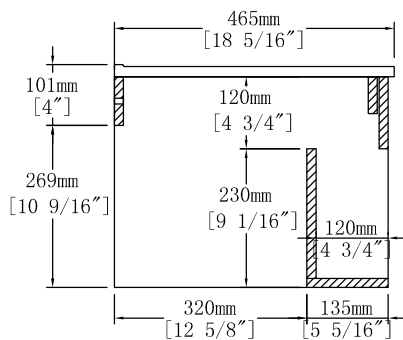

Side View

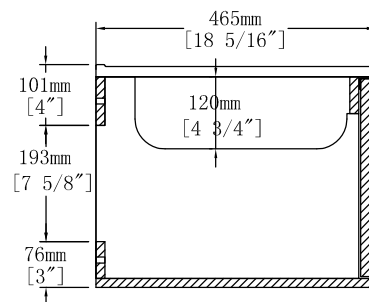

Item NO.	UNOR VB 003 24	Version	V1
Project		Date	2025-11-11