

INSTALLATION GUIDE

Before beginning to assemble and install your vanity, please check that you have received all of the parts and hardware listed in the Packing List. Please report any missing items to the store service.

To avoid scratches, scuffs, and other damages, do not of cardboard or another protective surface on the floor, and assemble your vanity on top of it. Always protect all surfaces from sharp objects, high heat sources, direct prolonged sunlight, and harsh chemicals.

Professional installation is recommended.

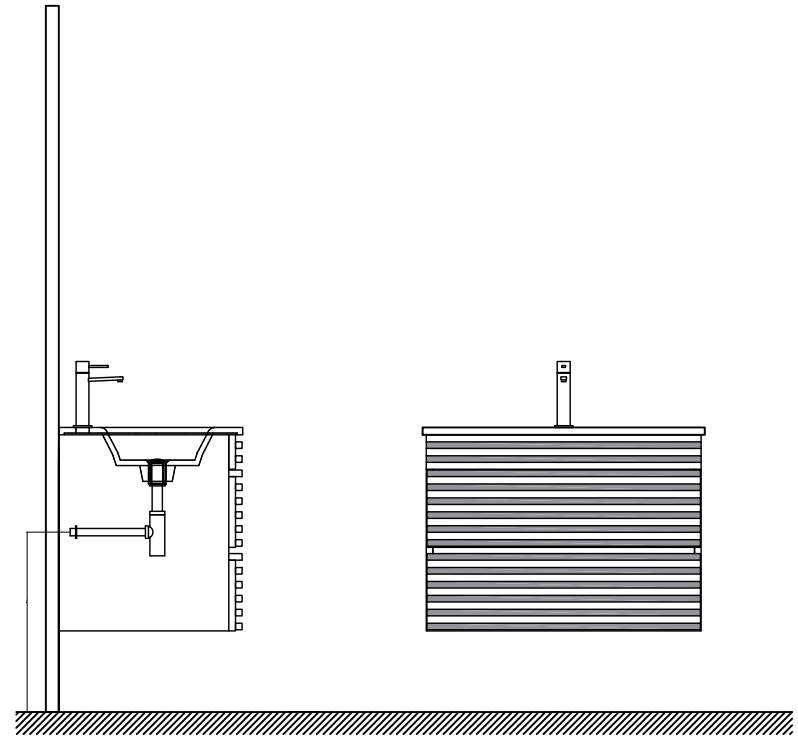

PACKING LIST (Please refer to order per retailer)

(A) Main cabinet

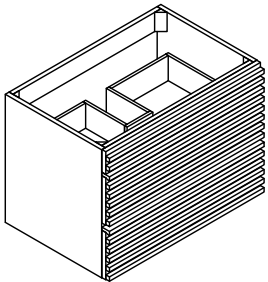

(B) Integrated Counter + Basin (1PCS)

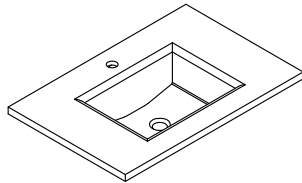

(C) Wall Anchor (3PCS)

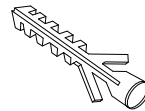

(D) Wood Screw (3PCS)

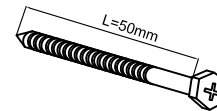

M5 x 50

INSTALLATION GUIDE

REQUIRED TOOLS

Glove



Safety Glasses



Drill Bits

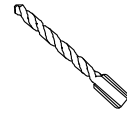

Ø3/8" (8mm)dia.

HSS

Drill

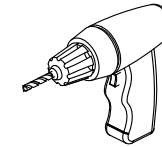

Measuring Tape

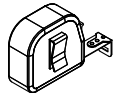

Pencil

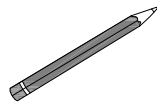

Screw Driver

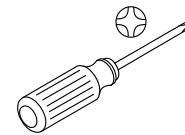

Level

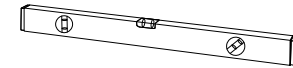

Silicone

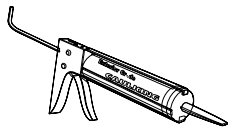

Soft Head Hammer

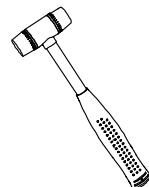

INSTALLATION GUIDE

STEP 1

- Use a wood stud finder to locate the wood studs behind the walls.
- Use a pencil to mark the installation location for the Wall Anchor (**C**).
- Use a level to ensure the Wall Anchor (**C**) will be level before installing to the wall.

NOTE

Make sure the screw holes must be on the wood studs otherwise the vanity will fall out because the dry wall cannot hold the cabinet.

Drill the anchor holes according to the marks using a drill.

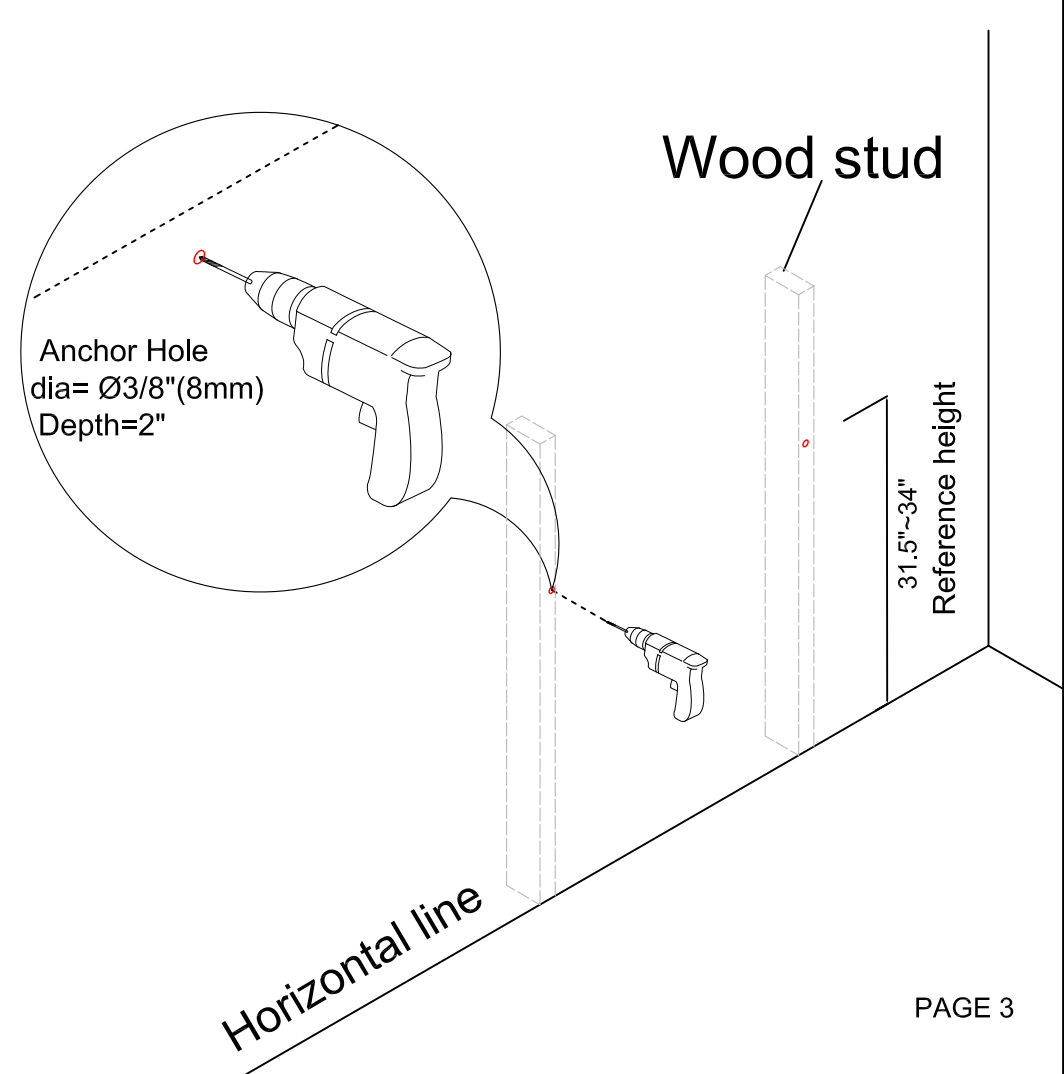
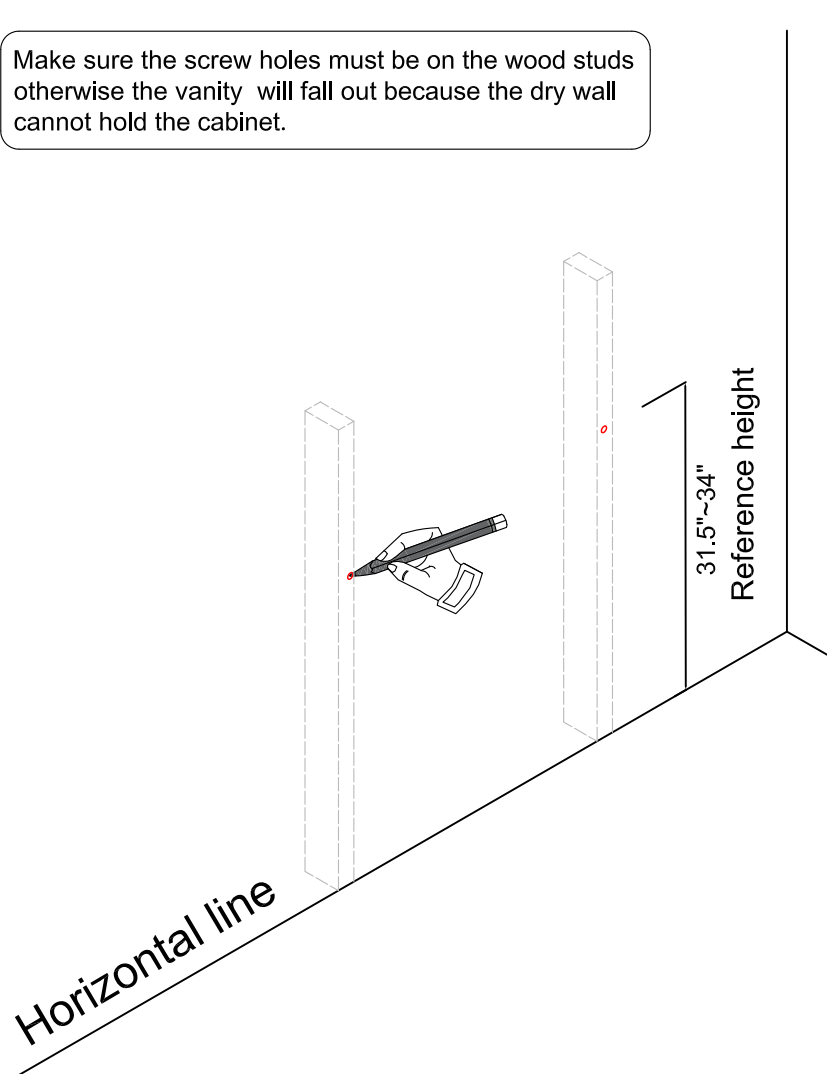

INSTALLATION GUIDE

STEP 2

Install the Wall Anchor (C) provided into the wall with hammer.

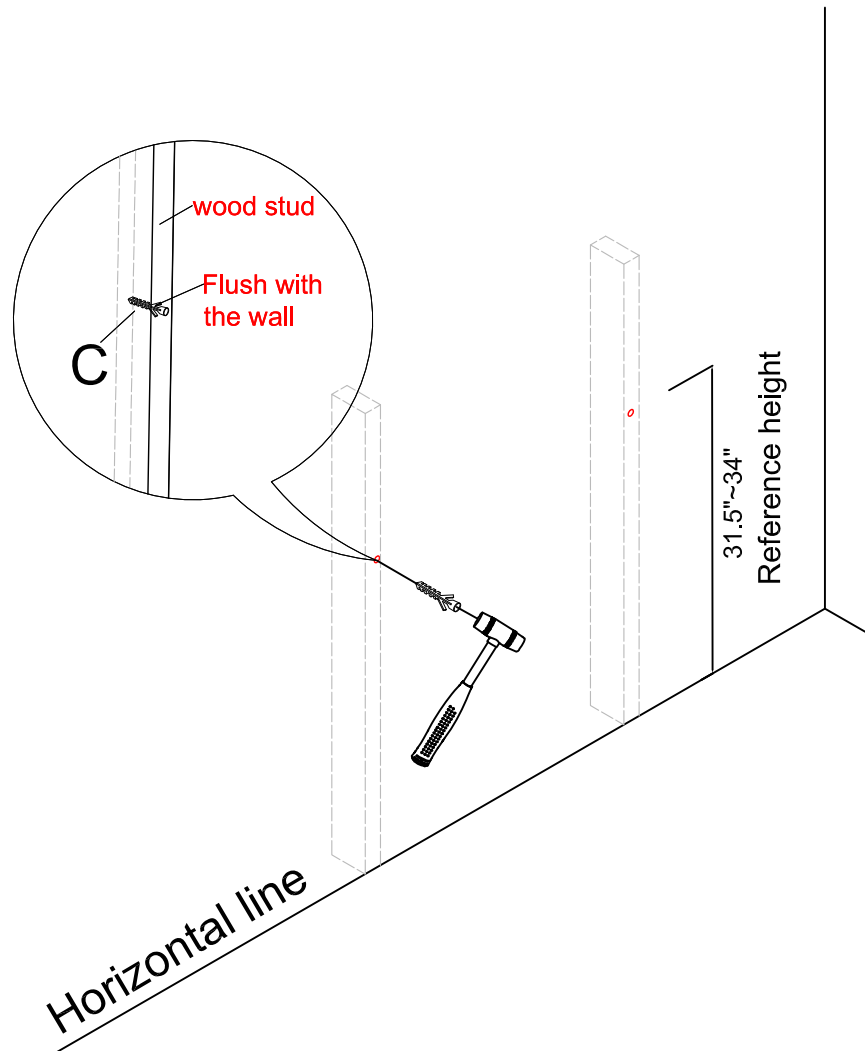

STEP 3

With help from another person, carefully hang the **Cabinet (A)** onto the **Wall** .

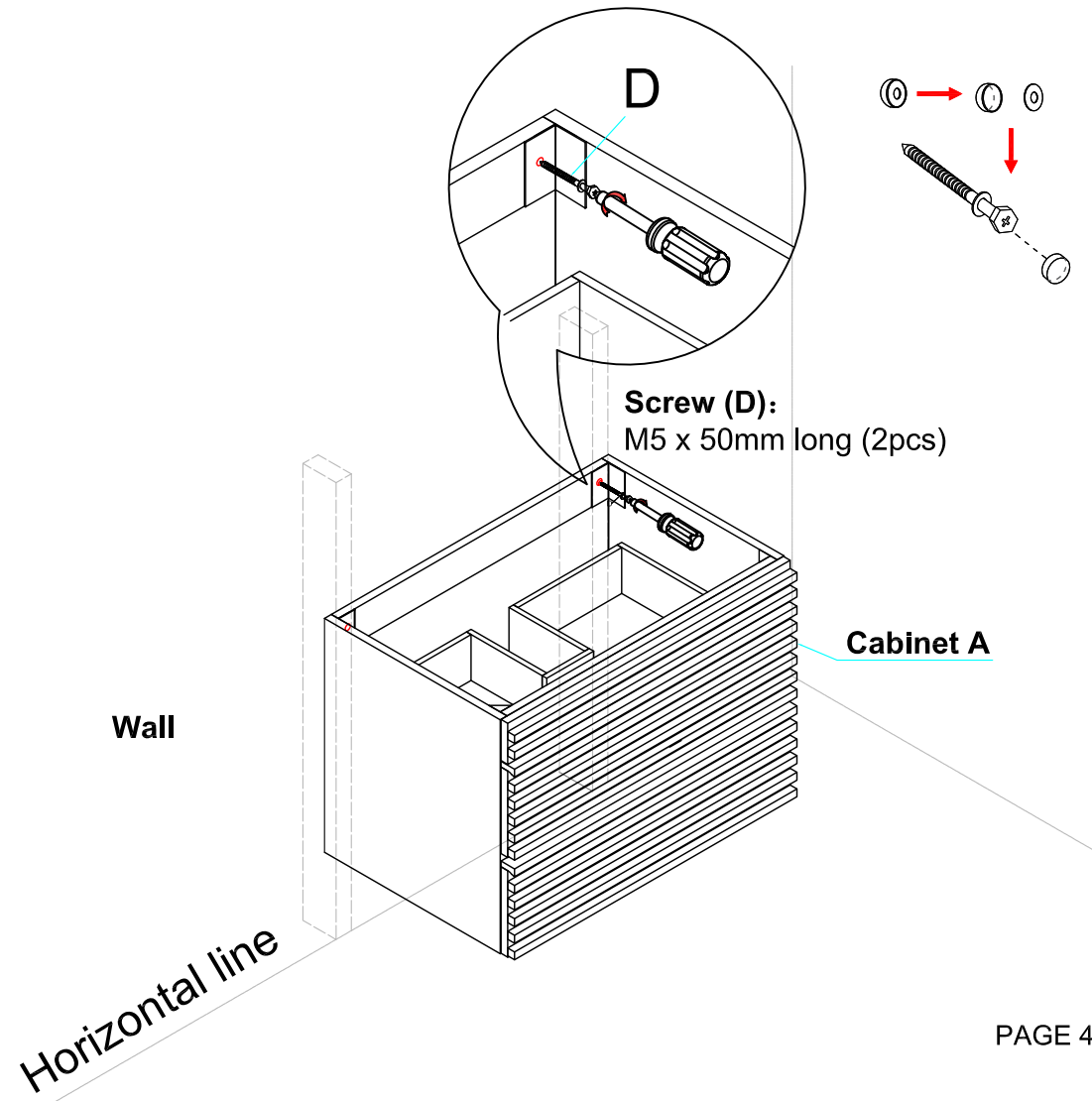

INSTALLATION GUIDE

STEP 4

Apply caulk to the perimeter of the top of the cabinet.

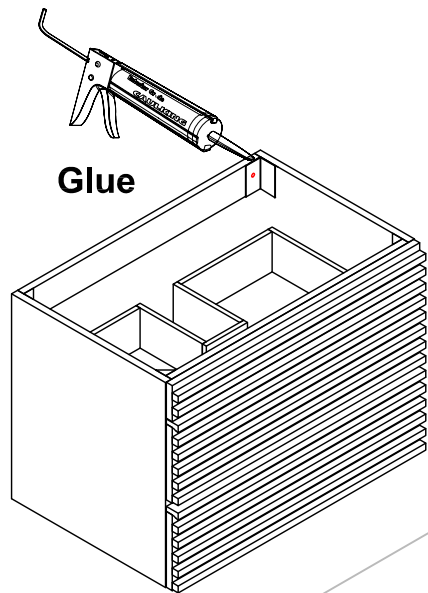

STEP 5

Install the countertop and attached basin so that the rim of the countertop rests on the caulk.

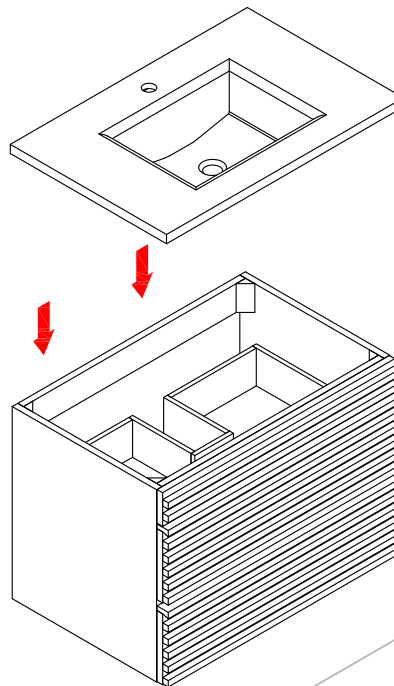

STEP 6

