

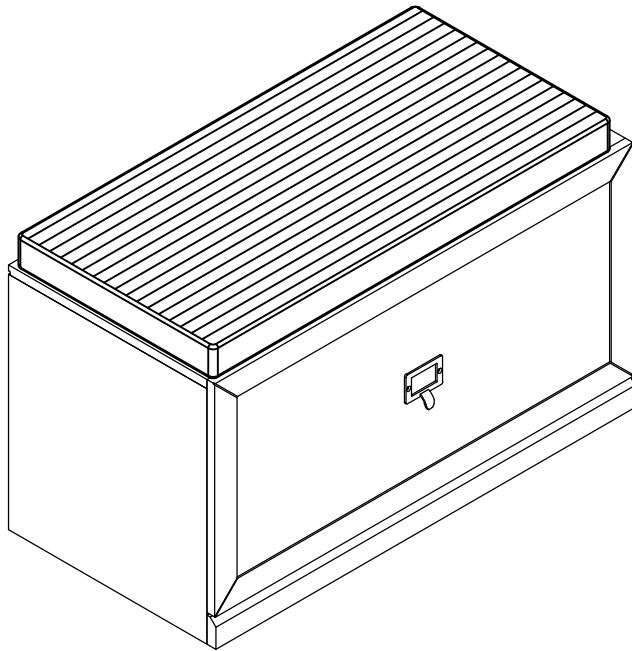

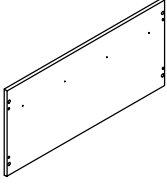

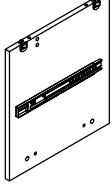

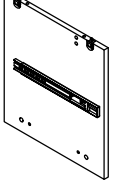
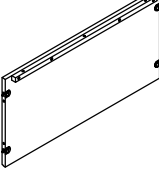
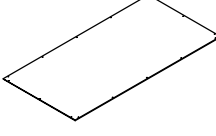
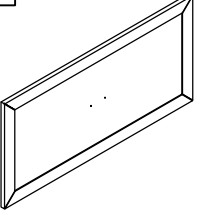
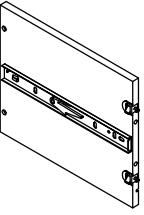
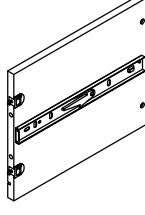
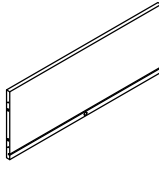
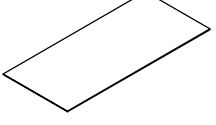
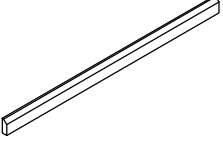
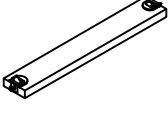
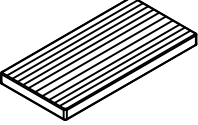
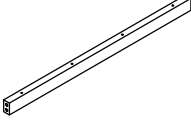

Entryway Bench

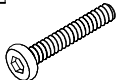

PART LIST

				
<p>Seat Panel 1 PC</p>	<p>Left Panel 1 PC</p>	<p>Right Panel 1 PC</p>	<p>Bottom Panel 1 PC</p>	<p>Back Panel 1 PC</p>
				
<p>Drawer Front Panel 1 PC</p>	<p>Drawer Left Panel 1 PC</p>	<p>Drawer Right Panel 1 PC</p>	<p>Drawer Back Panel 1 PC</p>	<p>Drawer Bottom Panel 1 PC</p>
				
<p>Bottom Rail 1 PC</p>	<p>Bottom Bar 1 PC</p>	<p>Seat Cushion 1 PC</p>	<p>Support Rail 1 PC</p>	

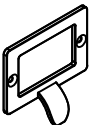
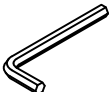
HARDWARE LIST

#1		#2		#3		#4		#5	
	Ø3*12mm		Ø3*15mm		Ø3*30mm		Ø1/4"*1-1/4"		Ø8*30mm
	Short Screw		Round Head Screw		Long Screw		Bolt		Wood Dowel
	2 PCS		16 PCS (Extra 1)		4 PCS		3 PCS		16 PCS (Extra 1)
#6		#7		#8		#9			
			4mm		Ø10*40mm		Ø4*35mm		
	Handle		Allen Wrench		Long Wood Dowel		Screw		
	1 PC		1 PC		4 PCS		4 PCS		

ADDITIONAL TOOLS (Not Provided)

Note: It is not recommended to use power tools during assembly.

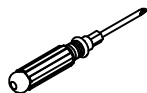

Phillips Head Screwdriver

Note: Wood dowels are intended for alignment. Additional clearance between wood dowel and pre-drilled hole is intentional for ease of assembly.

Please do not use tools to assemble this unit unless specifically indicated.

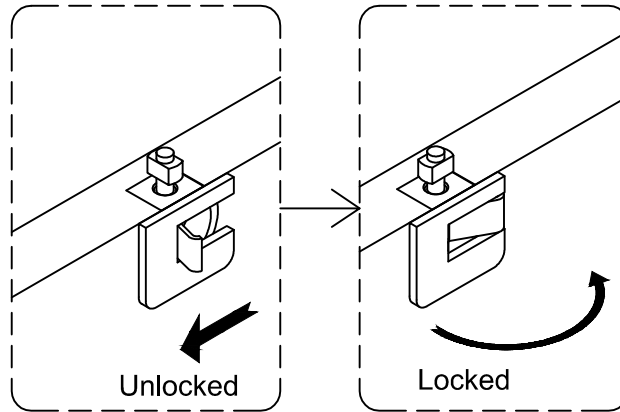

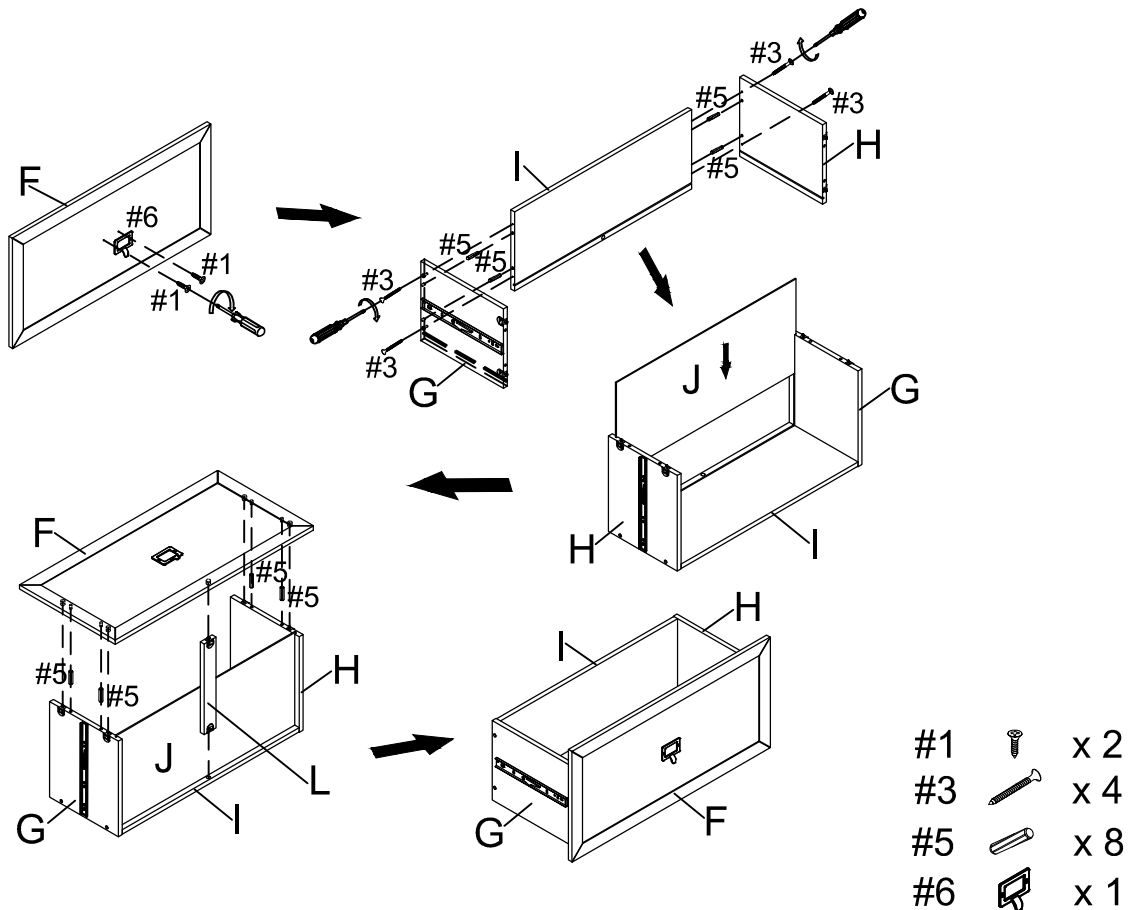

Reference the images above any time the instructions state "lock the hardware". Be sure to check all hardware is locked when complete.

Step 1. Attach handle (part #6) to drawer front panel (part F) using short screws (part #1) and phillips head screwdriver. Attach drawer left panel (part G) and drawer right panel (part H) to drawer back panel (part I) using wood dowels (part #5), long screws (part #3) and phillips head screwdriver. Slide drawer bottom panel (part J) into grooves of assembled unit (parts G, H & I). Attach drawer front panel (part F) and bottom bar (part L) to assembled unit (parts G, H & I) using wood dowels (part #5) and lock the hardware.

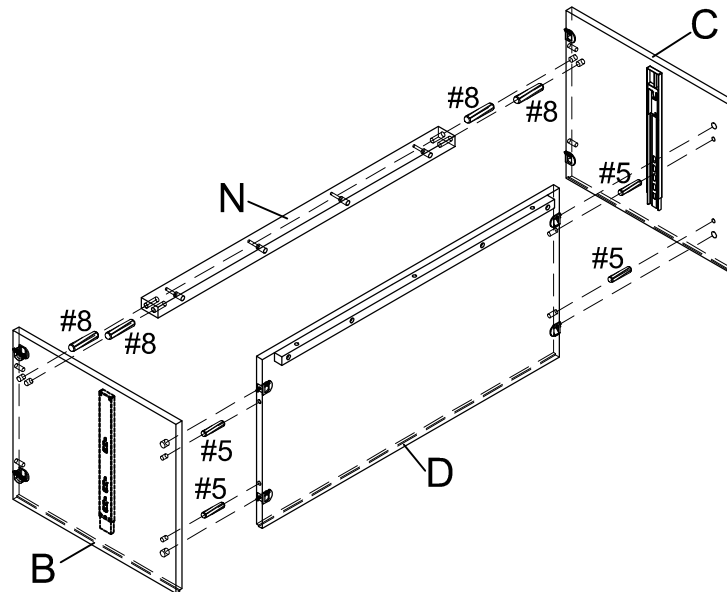

Step 2. Attach support rail (part N) and bottom panel (part D) to left panel (part B) and right panel (part C) using long wood dowels (part #8), wood dowels (part #5) and lock the hardware.



- #5  x 4
- #8  x 4

Step 3. Attach seat panel (part A) to panels (parts B & C) and support rail (part N) using wood dowels (part #5), screws (part #9), phillips head screwdriver and lock the hardware.

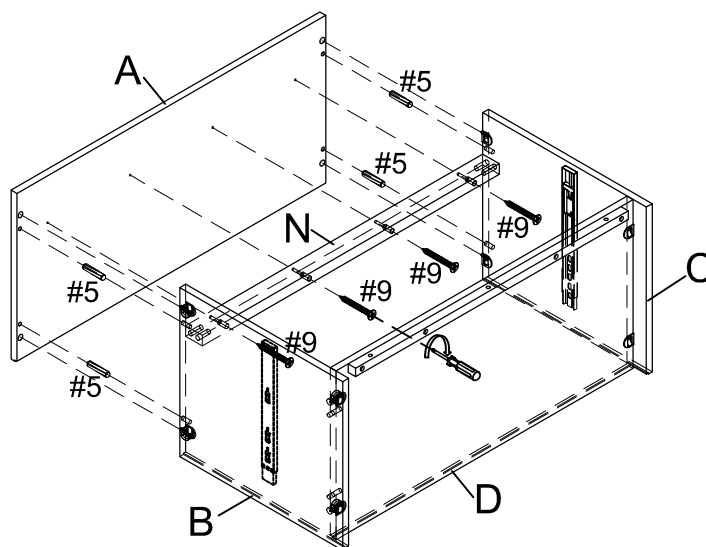

- #5  x 4
- #9  x 4

Step 4. Attach bottom rail (part K) to bottom panel (part D) using bolts (part #4) and allen wrench (part #7).

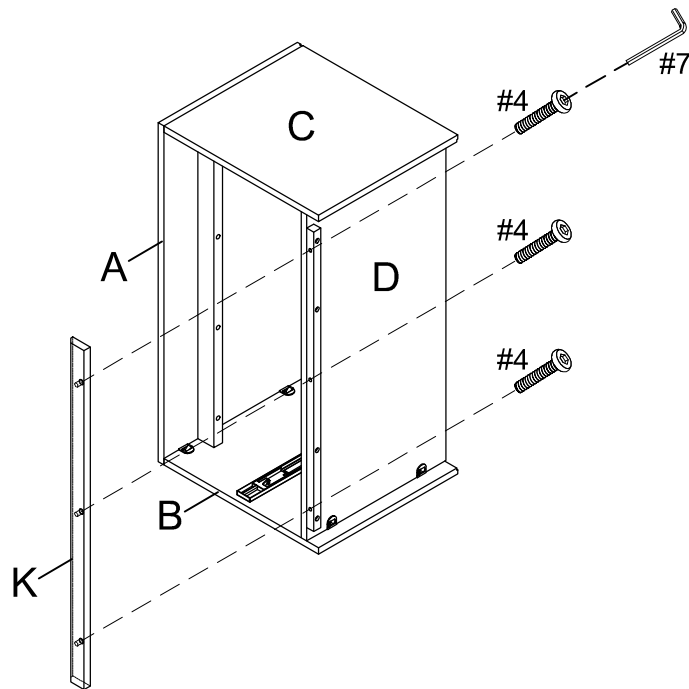

#4  x 3
 #7  x 1

Step 5. Carefully turn unit upright. Attach back panel (part E) to assembled unit (parts A, B, C & D) using round head screws (part #2) and phillips head screwdriver.

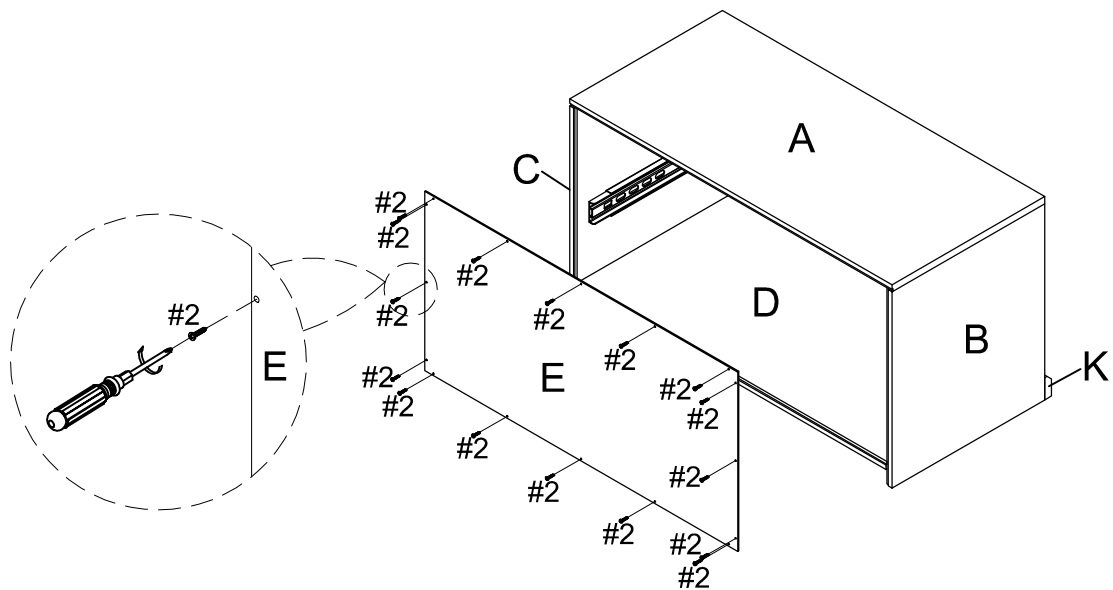

#2  x 16

Step 6. Slide assembled drawer into place.

Note: To release trigger disconnect levers push one side up and the other down.

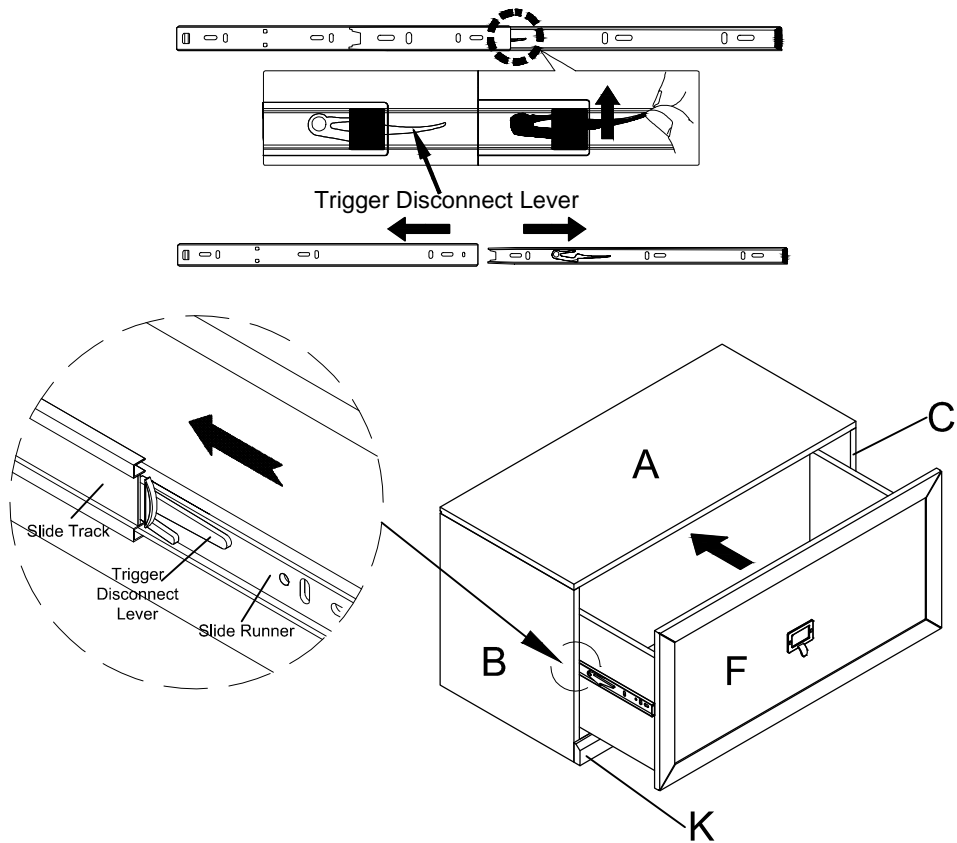

Step 7. Place seat cushion (part M) on seat panel (part A).

