

# Assembly Instruction Sheet for Model HL494421

## Package Contents



### STEP 1

1. Use the mounting screws to attach the mounting bracket onto the ceiling.

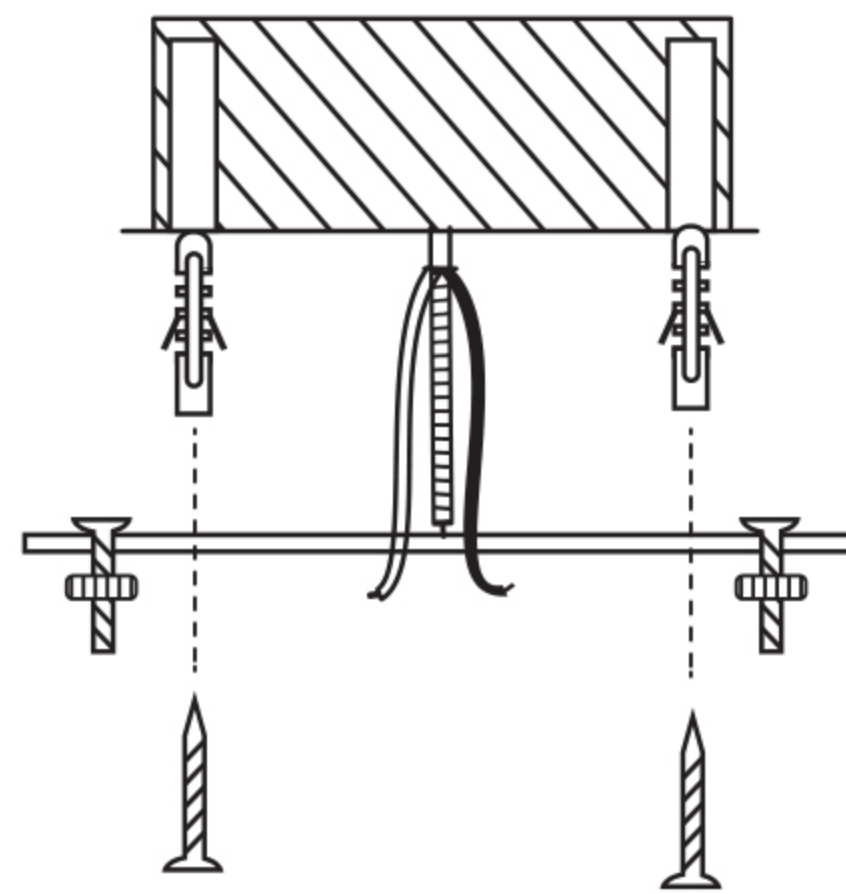

### STEP 2

2. Make the electrical connection from ceiling to the fixture. Connect the ground wire to the mounting bracket using the GREEN hex-head ground screw. Connect the ground wire with the ground wire from the ceiling. Then connect the live wire (fire wire) from the fixture with the live wire from the ceiling by wire connector. Connect the naught wire from the fixture with the naught wire from the ceiling by wire connector. As follow the picture.

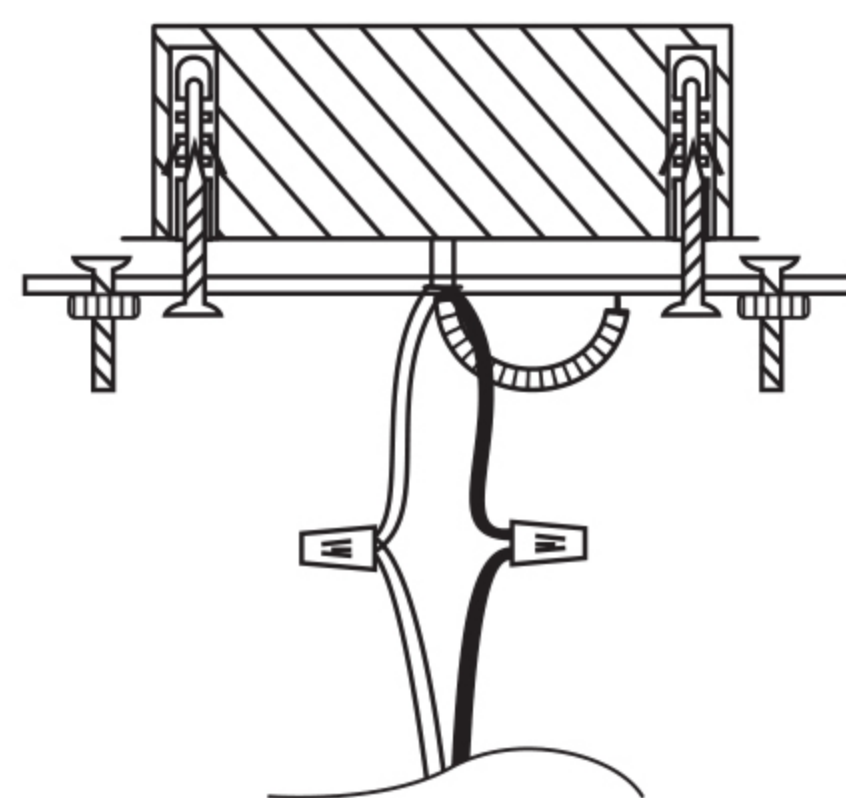

### STEP 3

3. Attach the canopy over the mounting bracket and secure with Mounting Screws . Tighten until snug with screwdrivers.

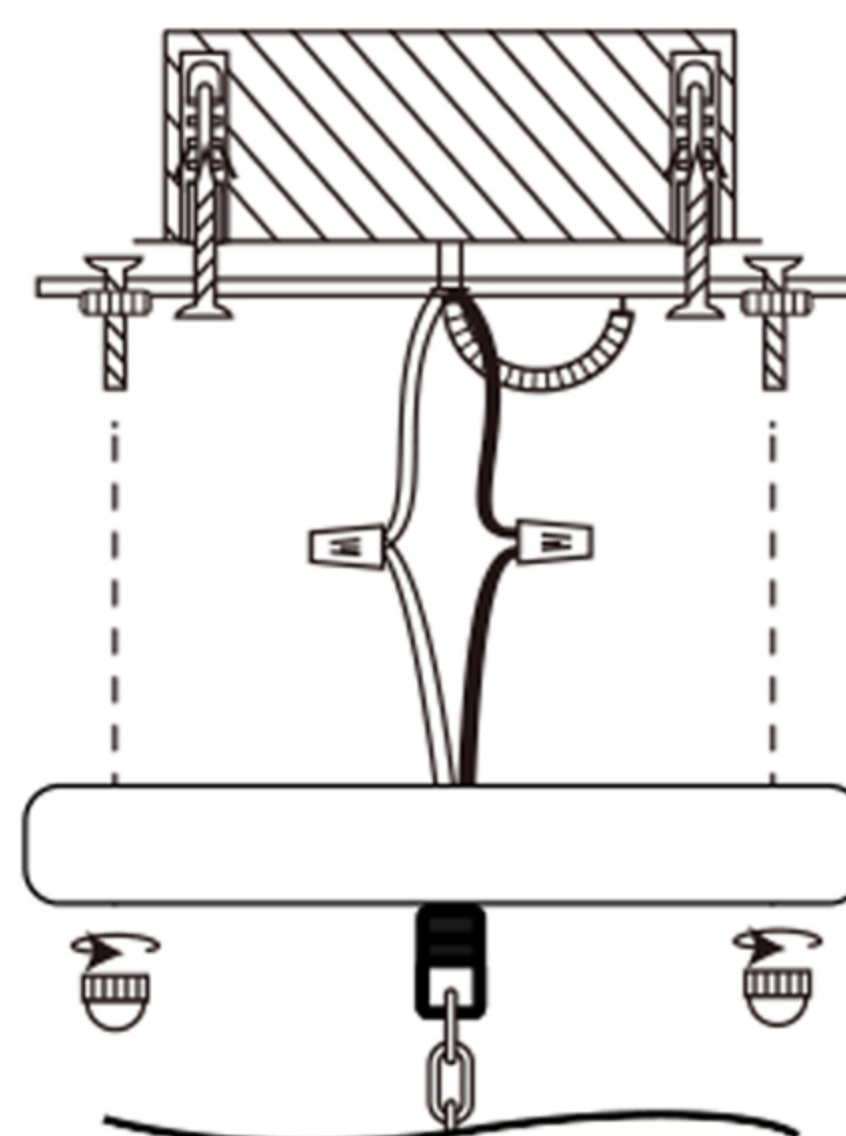

Your fixture is now assembled and ready to use.