

Assembly Instructions

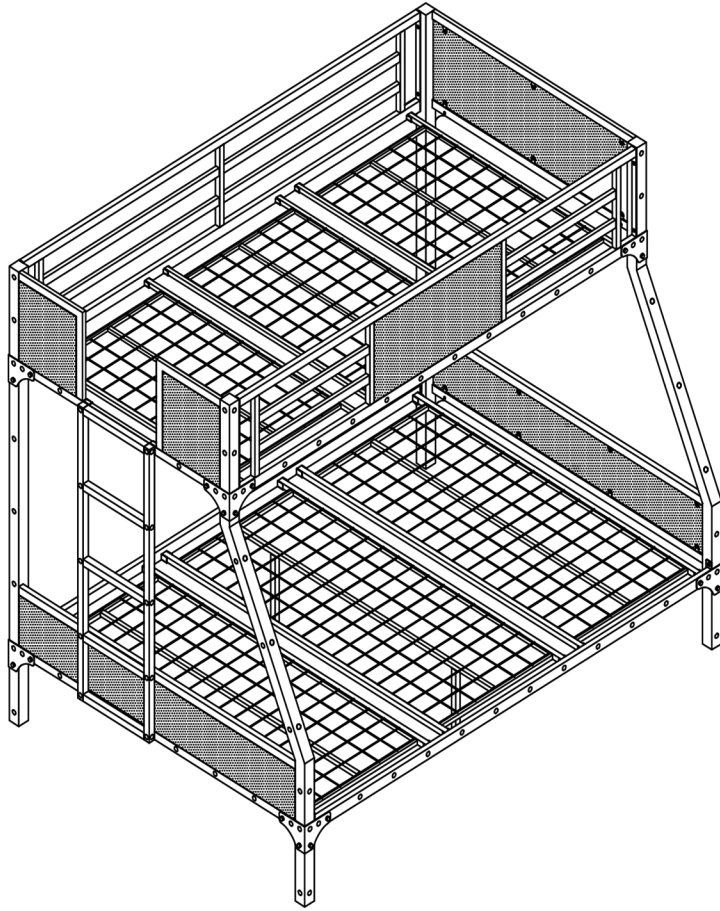

ASSEMBLY RATING

The Assembly Rating is a 5-point system that shows the degree of effort needed in assembling a specific product (with 1 being easy and 5 being difficult). For some products, two persons are recommended.

EASY



DIFFICULT

Tools Required For Assembly:

Allen Wrench

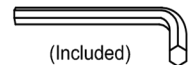

Wrench



2 PERSONS RECOMMENDED

ASSEMBLY & CARE ADVICE

FOR YOUR FURNITURE TO LAST, CORRECT ASSEMBLY AND PROPER MAINTENANCE ARE NECESSARY. PLEASE FOLLOW THE INFORMATION PROVIDED BELOW TO FULLY ENJOY YOUR FURNITURE.

BASIC ASSEMBLY TECHNIQUES

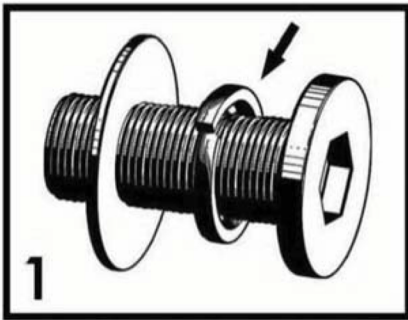

When lock or spring washer is used in an assembly, please make sure the lock or spring washer is placed between the larger flat washer and the head of the screw or bolt.

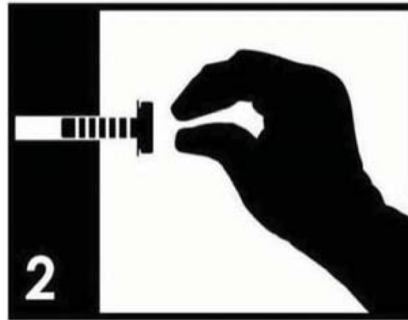

Position each part correctly and insert screws or bolts into their respective holes by hand tighten or using the proper hand tool. Only tighten when step is completed or when instructed to do so.

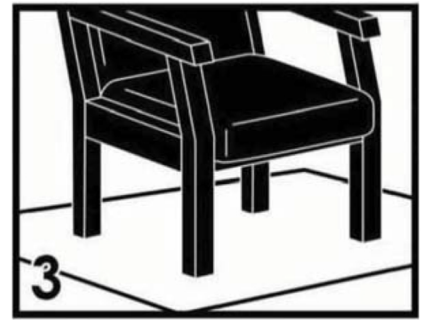

Use cardboard or carpet area when assembling furniture to prevent scratches. Make sure the furniture rests on a flat and level surface with each leg evenly touching the floor.

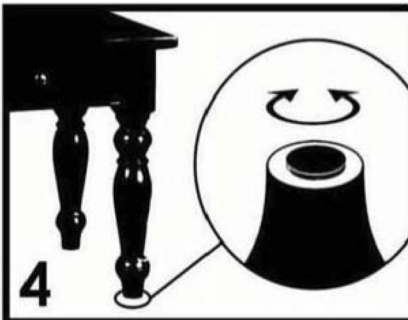

Some furniture comes with height adjustment knobs underneath each leg. To lower or to raise each leg, you need to turn clockwise or counterclockwise, respectively.

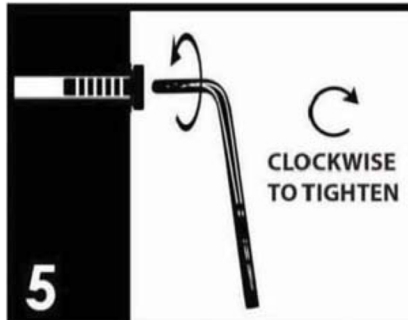

Make sure all parts are properly aligned, then use the appropriate hand tool to completely tighten the bolts or screws. Do not use power tools and do not overtighten.

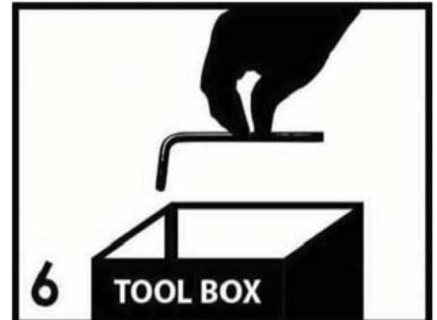

Save the instructions and store the Allen wrench or any supplied tool for later maintenance. After two weeks, check and tighten any loose hardware and repeat again every six months thereafter.

IT IS THE USER'S RESPONSIBILITY TO MAINTAIN THE FURNITURE. THE HARDWARE MAY LOOSEN OVER TIME AND MAY CAUSE THE FURNITURE TO BE WOBBLY AND UNABLE TO SUPPORT ITS INTENDED WEIGHT CAPACITY. THIS MAY LEAD TO COLLAPSE AND MAY CAUSE SERIOUS INJURY.



FAILURE TO FOLLOW THE GUIDELINES ABOVE MAY RESULT IN INJURY AND/OR PROPERTY DAMAGE.



Before you begin, please read Page 2 of "Assembly and Care Advice".

And remember, do not tighten until each step is completed or instructed.

Parts List

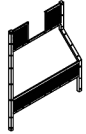

#1 x 1pc
Left Panel

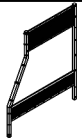

#2 x 1pc
Right Panel

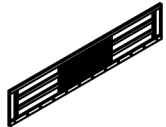

#3 x 1pc
Front Panel

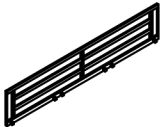

#4 x 1pc
Back Panel



#5 x 1pc
Front Side Rail

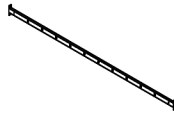

#6 x 1pc
Back Side Rail



#7 x 1pc
Ladder

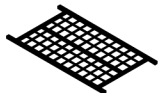

#8 x 3pcs
Base Frame 1

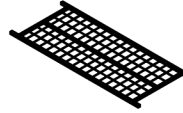

#9 x 1pc
Base Frame 2

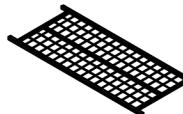

#10 x 2pc
Base Frame 3



#11 x 2pcs
Support Legs



#12 x 8pcs
Garnish

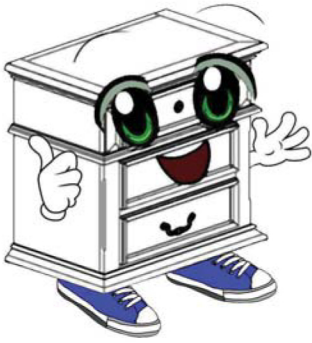

Before you begin, please read Page 2 of "Assembly and Care Advice".

And remember, do not tighten until each step is completed or instructed.

Hardware List



#A x 24pcs
Bolt $\text{\O}1/4\text{"X } 5/8\text{"}$



#B x 16pcs
Bolt $\text{\O}1/4\text{"X } 3/4\text{"}$



#C x 4pcs
Bolt $\text{\O}1/4\text{"X } 1-1/4\text{"}$



#D x 2pcs
Bolt $\text{\O}1/4\text{"X } 1-3/4\text{"}$

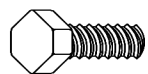

#E x 32pcs
Bolt $5/16\text{"x } 1/2\text{"}$



#F x 46pcs
Flat Washer $\text{\O}16$



#G x 1pc
Allen Wrench M4

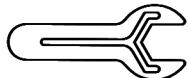



#H x 1pc
14mm Wrench



ASSEMBLY

Do not fully tighten all bolts until assembly is complete. This will help all parts to assemble properly.

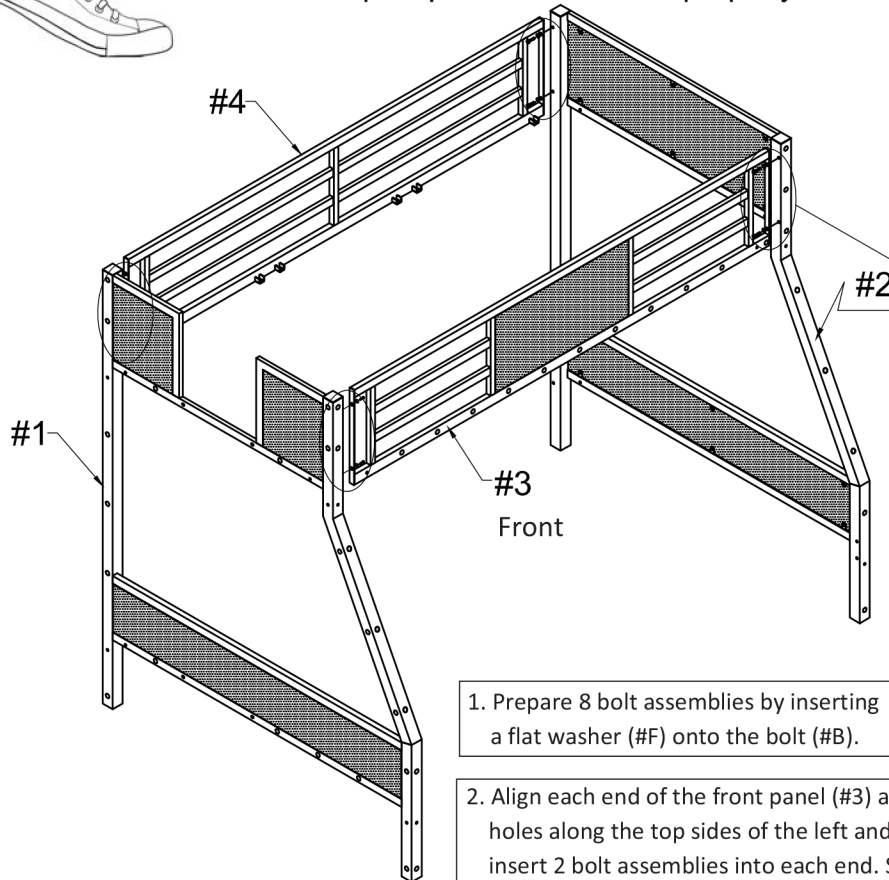

- #B  8pcs
- #F  8pcs
- #G 



1. Prepare 8 bolt assemblies by inserting a flat washer (#F) onto the bolt (#B).

2. Align each end of the front panel (#3) and back panel (#4) to the holes along the top sides of the left and right panel (#1,2). Then insert 2 bolt assemblies into each end. Secure using the Allen wrench.





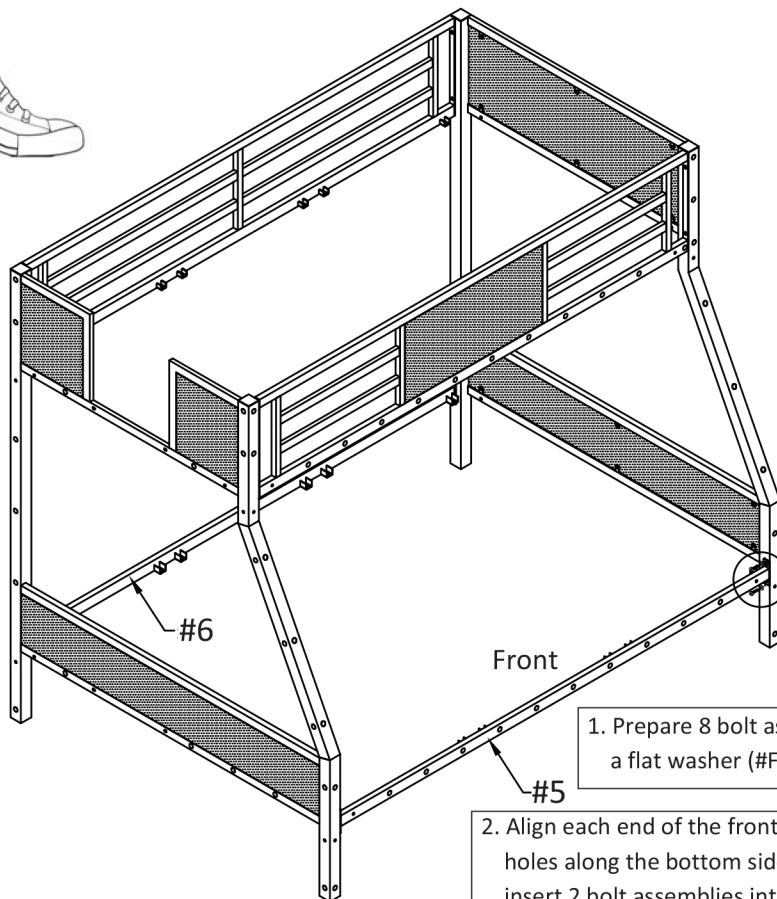

- #B  8pcs
- #F  8pcs
- #G 

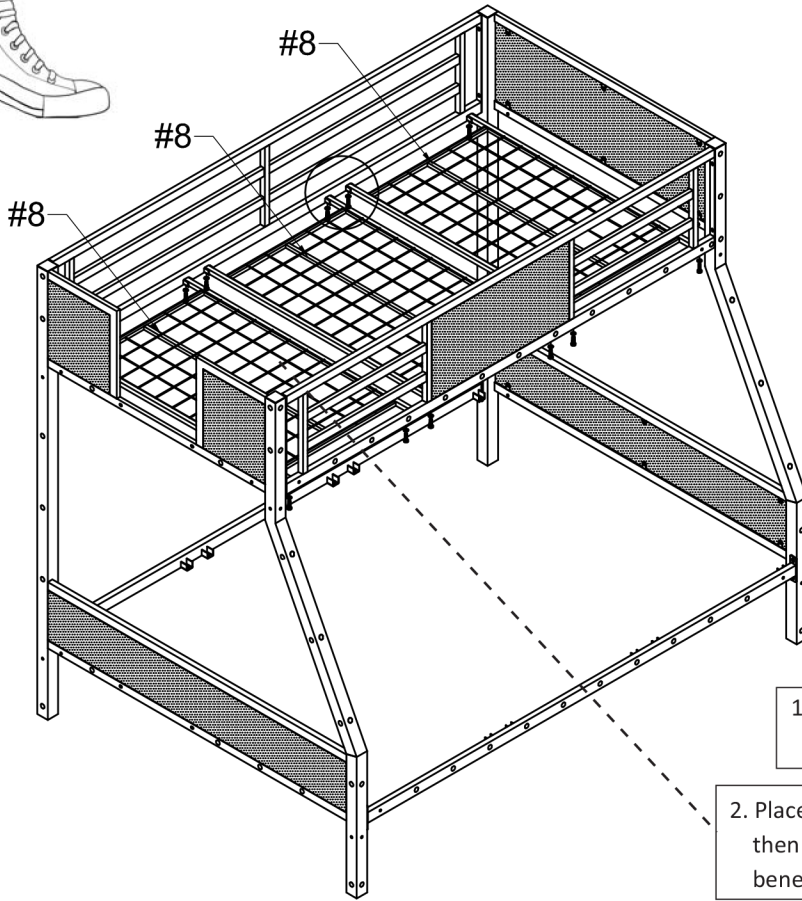

1. Prepare 8 bolt assemblies by inserting a flat washer (#F) onto the bolt (#B).

2. Align each end of the front side rail (#5) and back side rail (#6) to the holes along the bottom sides of the left and right panel (#1,2). Then insert 2 bolt assemblies into each end. Secure using the Allen wrench.





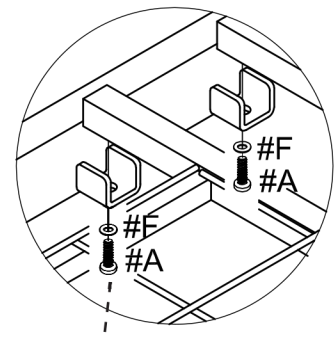

- #A  12pcs
- #F  12pcs
- #G 

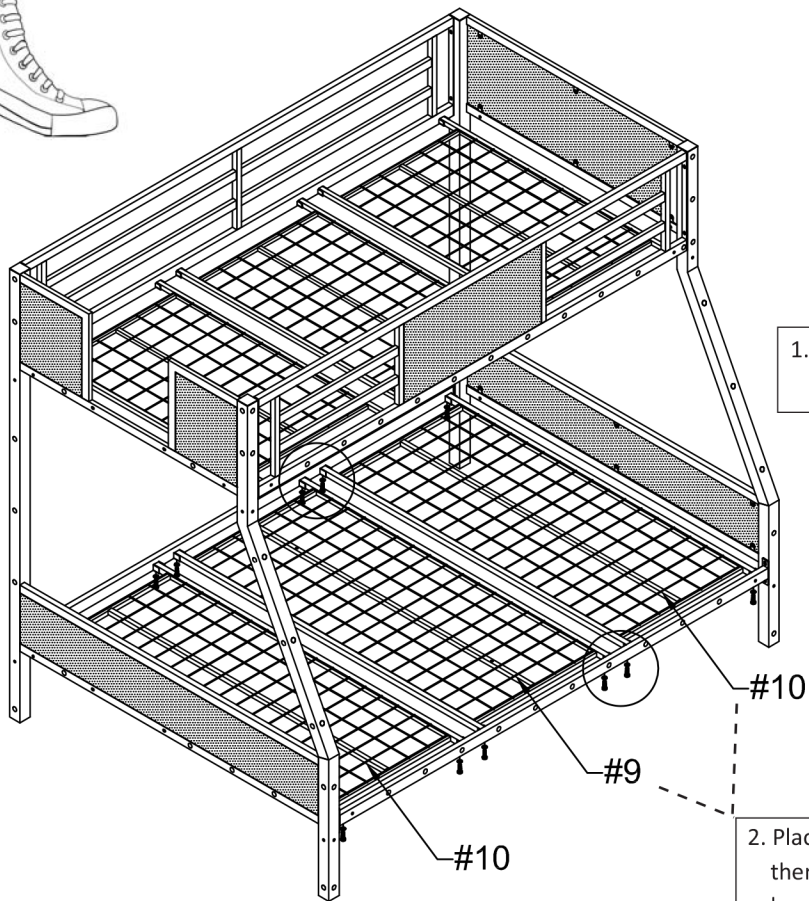

1. Prepare 12 bolt assemblies by inserting a flat washer (#F) onto the bolt (#A).

2. Place the base frames 1 (#8) onto the top bed, then insert a bolt assembly into each end from beneath. Secure using the Allen wrench (#G).





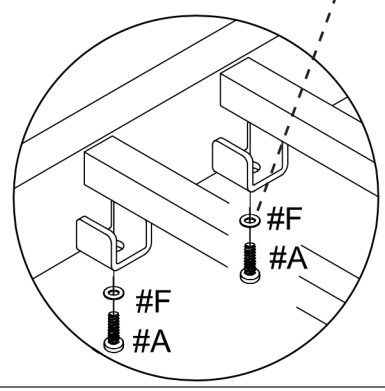

- #A  12pcs
- #F  12pcs
- #G 

1. Prepare 12 bolt assemblies by inserting a flat washer (#F) onto the bolt (#A).

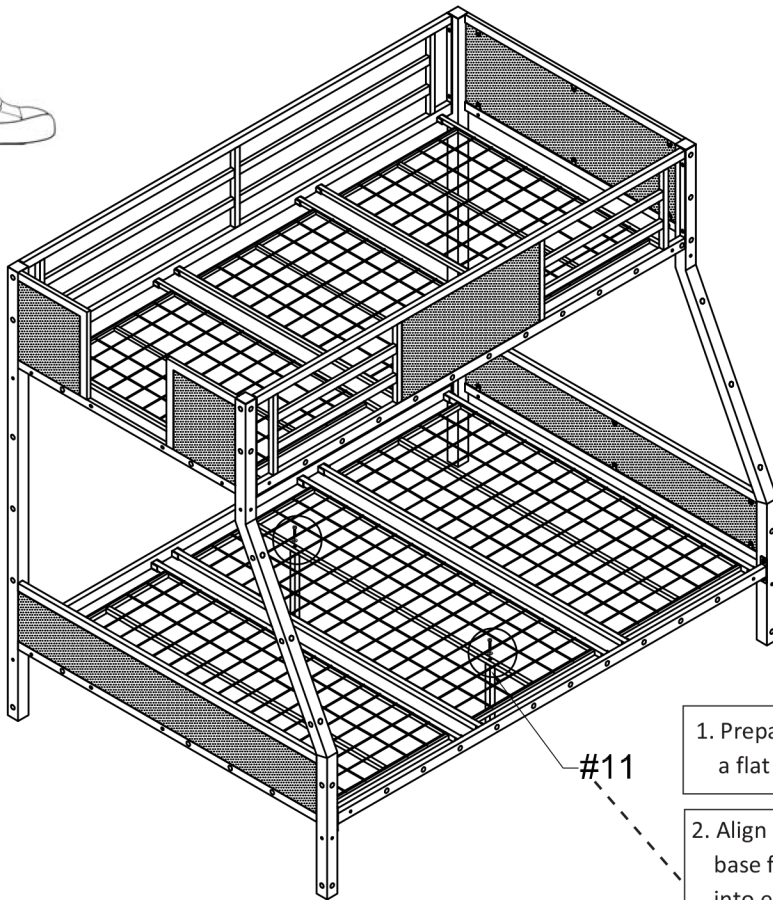

2. Place the base frames (#9,10) onto the top bed, then insert a bolt assembly into each end from beneath. Secure using the Allen wrench (#G).



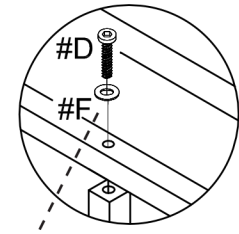

- #D  2pcs
- #F  2pcs
- #G 



1. Prepare 2 bolt assemblies by inserting a flat washer (#F) onto the bolt (#D).
2. Align 2 support legs (#11) to the bottom of the base frame (#9). Then insert a bolt assembly into each and secure using the Allen wrench.



1. Prepare 4 bolt assemblies by inserting a flat washer (#F) onto the bolt (#C).

- #C  4pcs
- #F  4pcs
- #G 

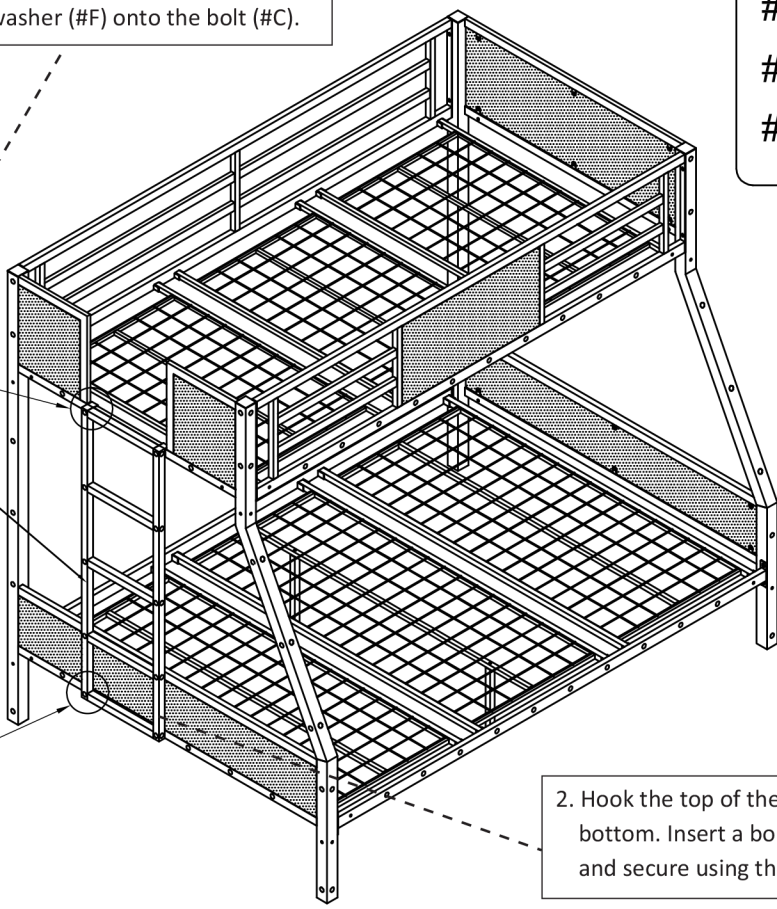
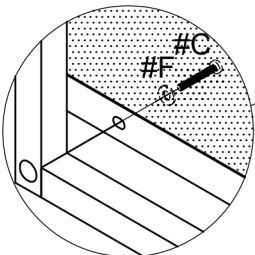
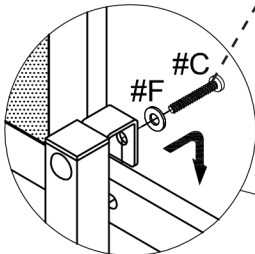

2. Hook the top of the ladder (#7) and align the bottom. Insert a bolt assembly into each end and secure using the Allen wrench (#G).



#E  32PCS

#H 

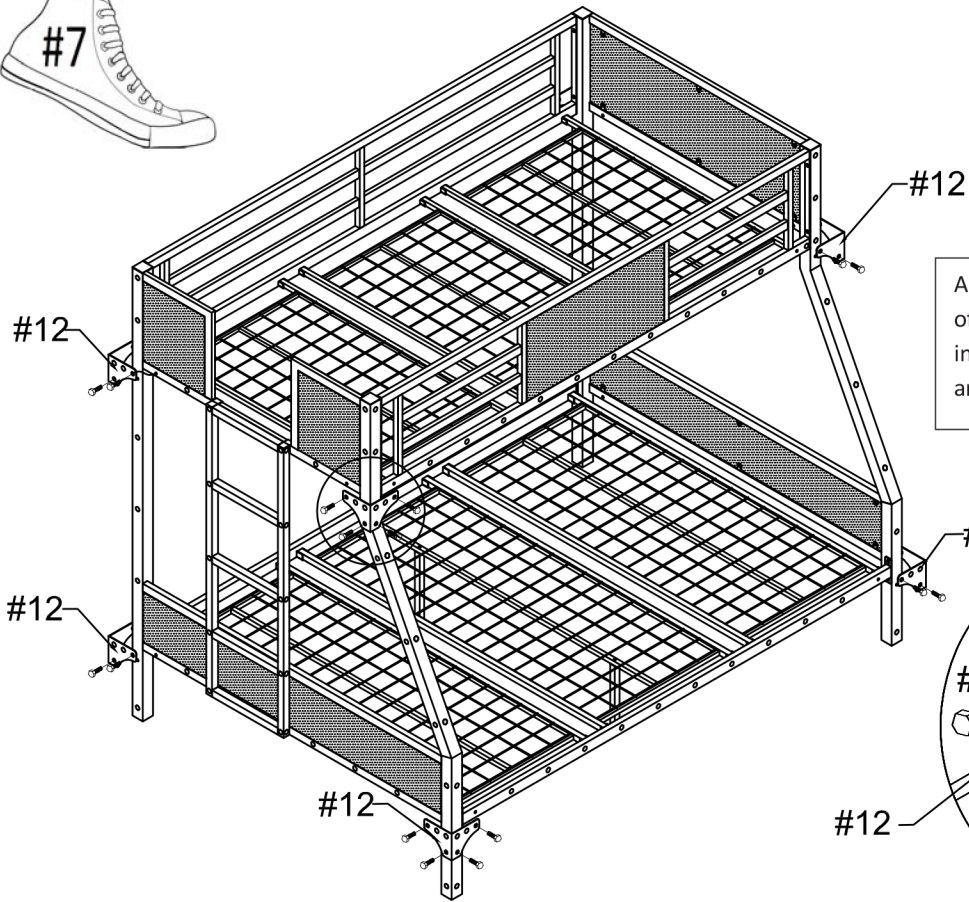

Align the garnish (#12) to each corner of the top and bottom beds, then insert 4 bolts (#E) into each garnish and secure using the wrench (#H).

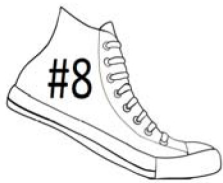
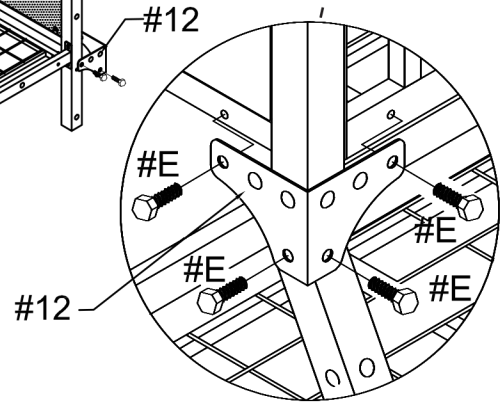

FOLLOW THE INFORMATION ON THE WARNING APPEARING ON THE UPPER BUNK END STRUCTURE AND ON THE CARTON. DO NOT REMOVE WARNING LABEL FROM BED.KEEP THESE INSTRUCTION FOR FUTURE REFERENCE.

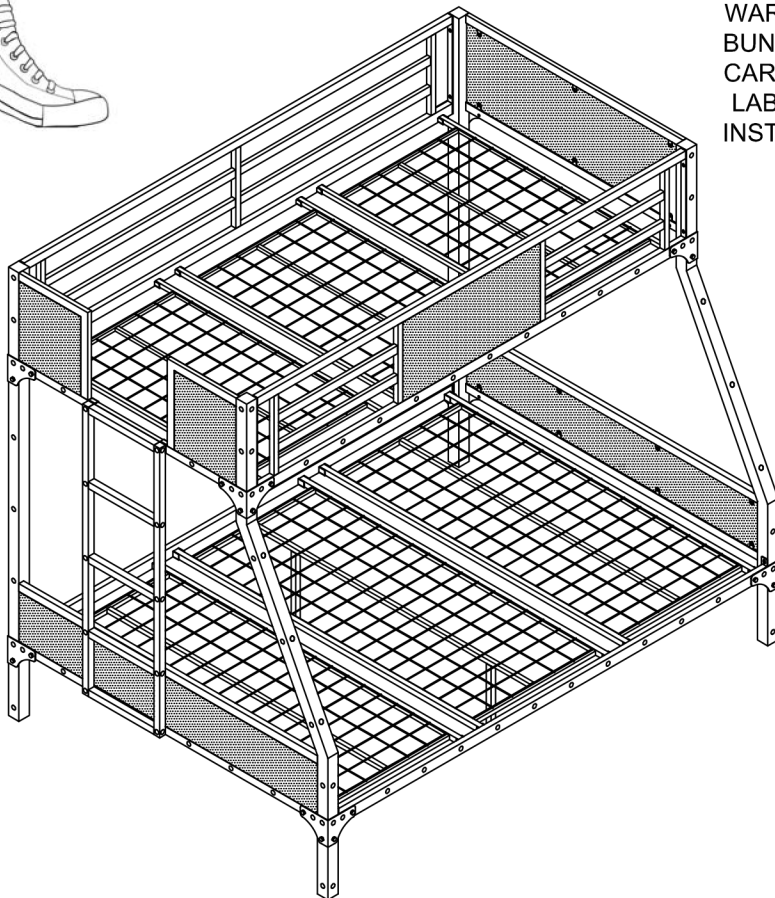

Safety Warnings

1. Follow the information on the warnings appearing on the upper bunk end structure and on the carton . Do not remove warning label from bed.
2. Always use the recommended size mattress or mattress support, or both, to help prevent the likelihood of entrapment or falls.
3. Surface of mattress must be at least 5 in(127mm). below the upper edge of guardrails .
4. Do not allow children under 6 years of age to use the upper bunk.
5. Periodically check and ensure that the guardrail, ladder ,and other components are in their proper position ,free from damage ,and that all connectors are tight .
6. Do not allow horseplay on or under the bed and prohibit jumping on the bed.
7. Always use the ladder for entering and leaving the upper bunk.
8. Do not use substitute parts ,Contact manufacturer or dealer for replacement parts.
9. Use of a night light may provide added safety precaution for a child using the upper bunk.
10. Always use guardrails on both long sides of the upper bunk.
If the bunk bed will be placed next to the wall, the guardrail that runs the full length of the bed should be placed against the wall to prevent entrapment between the bed and the wall.
11. The use of water or sleep flotation mattress is prohibited .
12. Keep these instructions for future reference.
13. Use only mattress which is (74"-75")X(37 $\frac{1}{2}$ "-38 $\frac{1}{2}$ ")X6" on upper bunk and for bottom bunk required (74"-75")X(53 $\frac{1}{2}$ "-54 $\frac{1}{2}$ ")X8" mattress.
14. Prohibit more than one person on upper bunk.
15. Maximum total weight is not to exceed 400 lbs.on the upper bunk.

STRANGULATION HAZARD:

Never attach or hang items to any part of the bunk bed that are not designed for use with the bed, for example, but not limited to, hooks, belts, and jumpropes.