







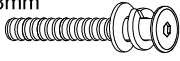

# ASSEMBLY INSTRUCTIONS

## SOFA - 1 SEATER

### IMPORTANT NOTE :

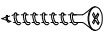
- \* PLACE ALL WOODEN PARTS ON A CLEAN AND SMOOTH SURFACE SUCH AS A RUG OR CARPET TO AVOID THE PARTS FROM BEING SCRATCHED.
- \* BEFORE YOU BEGIN, KINDLY FOLLOW THE ASSEMBLY INSTRUCTIONS STEP BY STEP.

### HARDWARE LIST

A	JCBC M6 x 50mm + S/W M6 + F/W M6 x 13mm		6PCS
B	ALLEN KEY M4		1PC
C	BARREL NUT M6 x 13mm		4PCS
D	WOOD BUTTON Ø 14.5		6PCS
E	FH SCREW #8 X 32mm		2PCS
F	WOOD DOWEL M10 x 40mm		4PCS
G	L - BRACKET		2PCS
H	CSK SCREW M3.5 x 16mm		4PCS

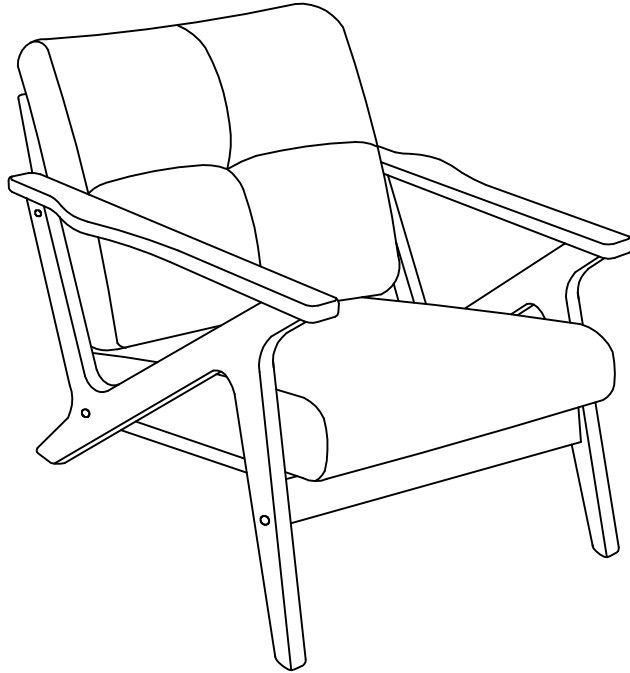

COMPLETED SOFA ASSEMBLY.

### PART LIST

1	SOFA LEG (L/R)	2PCS
2	FRONT RAIL	1PC
3	BACK FRAME	1PC
4	SEAT FRAME	1PC

### STEP 1

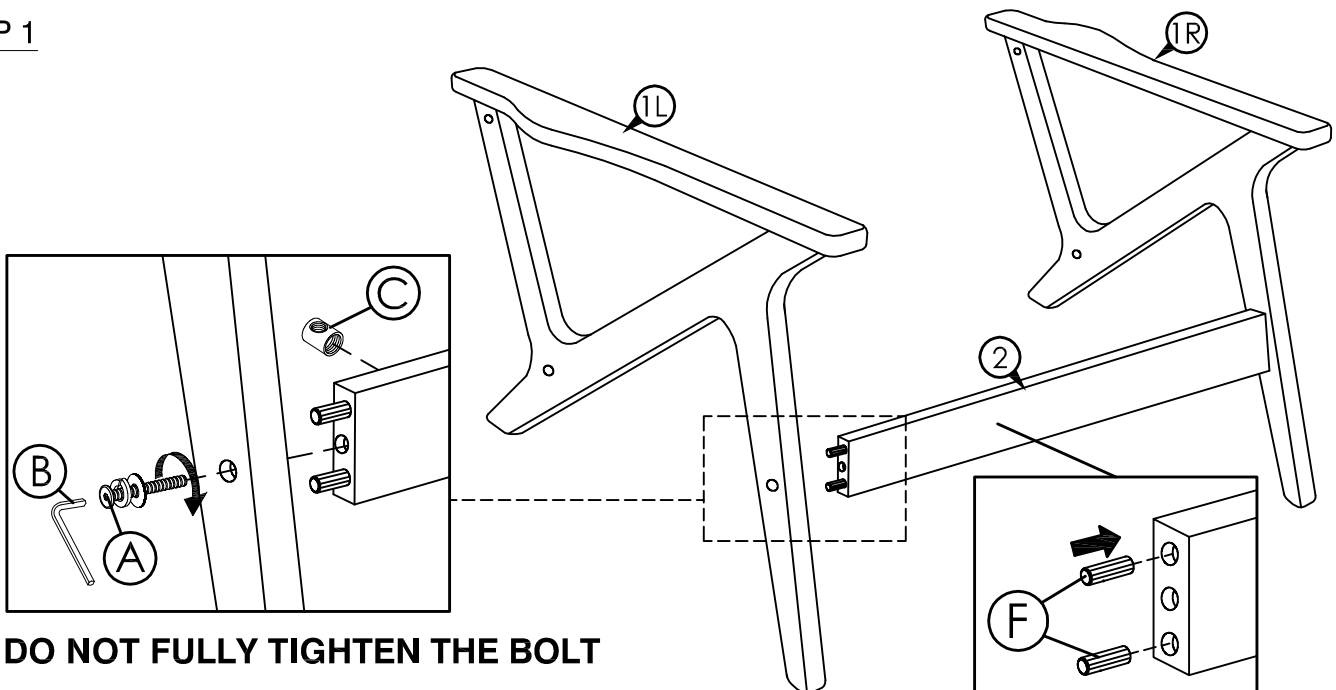

**DO NOT FULLY TIGHTEN THE BOLT**

# ASSEMBLY INSTRUCTIONS

## STEP 2

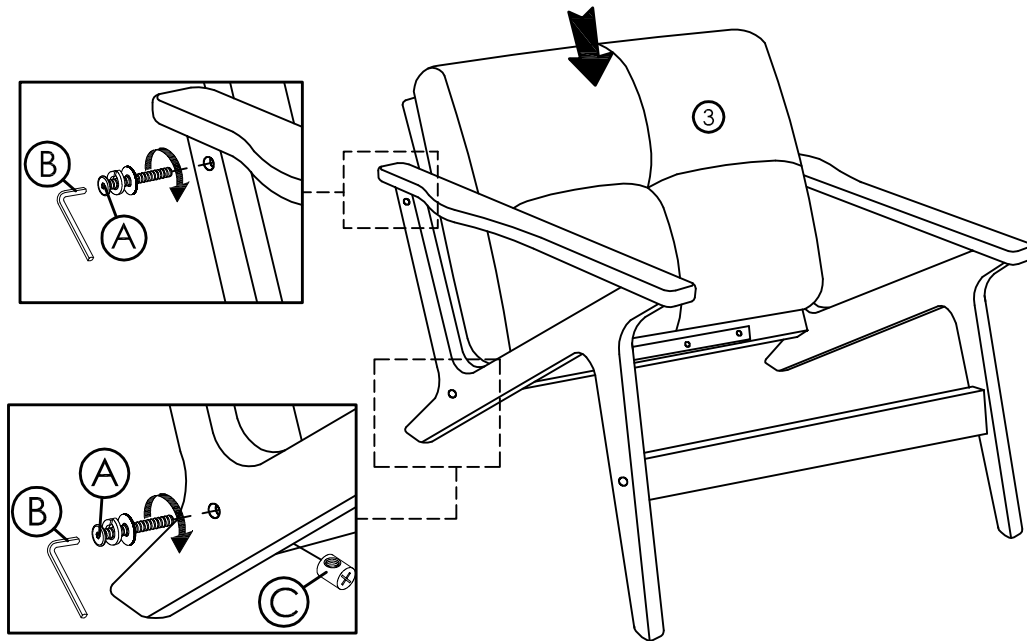

## STEP 3

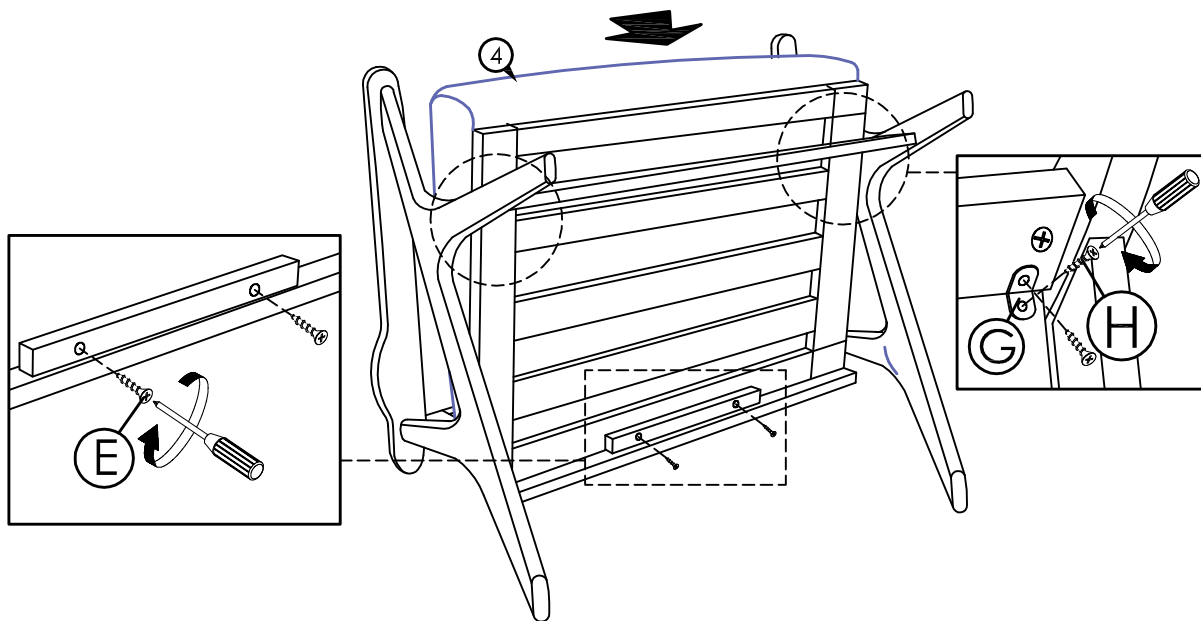

## STEP 4

