

Installation & Assembly

15 in x 43 in x 15 in

Assembly Steps:

A x 1

B x 1

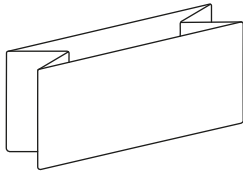
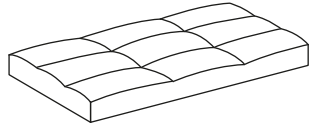

C x 1

D x 4

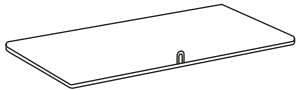

E x 4

F x 1

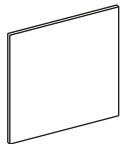

1

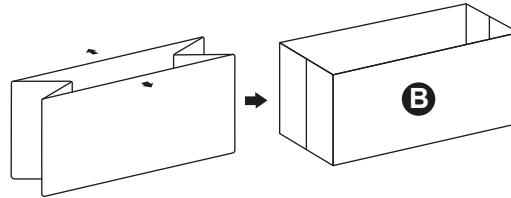

2

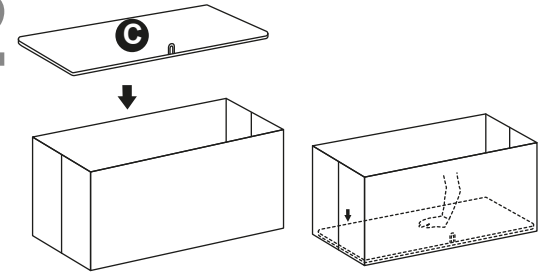

3

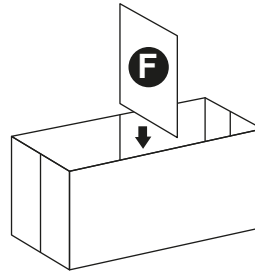

4

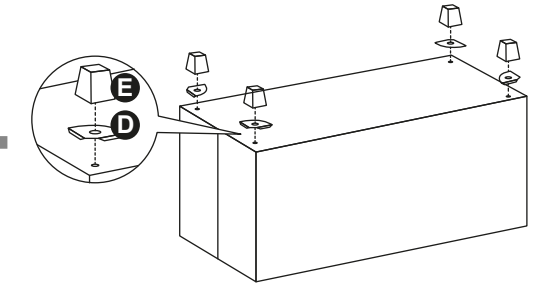

5

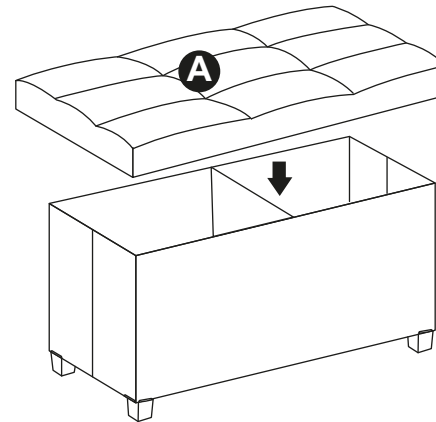

6

