

PL- Przed rozpoczęciem zapoznać się z instrukcją montażu/ DE- Vor die montage, bitte beiliegende anweisungen folgen/
EN- Before starting, refer to the assembling advice in annex/ CZ- Před zahájením naleznete v montážním návodu/ HR- Prije početka, uzmite upute za montažu u prilogu/
HU- A termék összeszerelését megelőzően kérjük olvassa el az összeszerelési útmutatóban leírtakat/ SK- Pred začiatkom si prečítajte pokyny na montáž

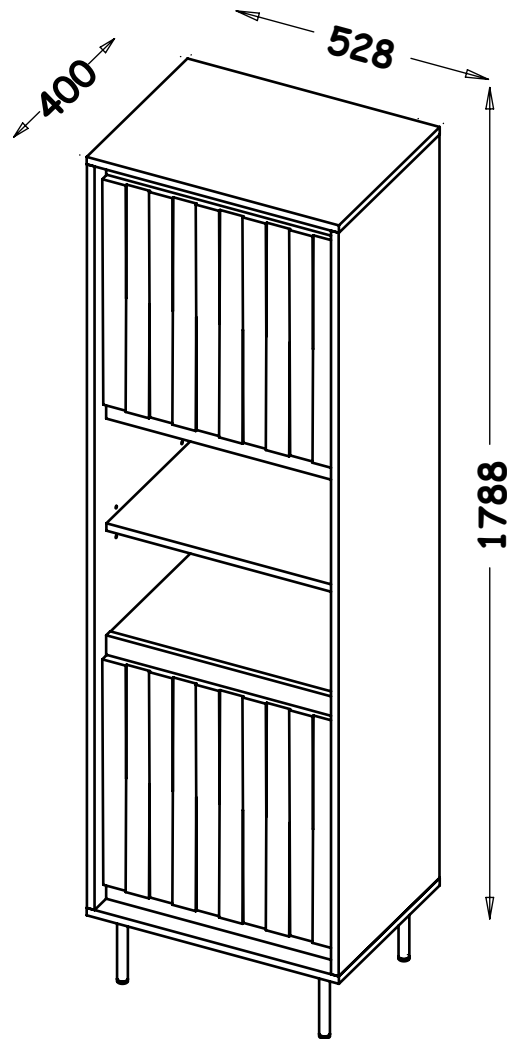

PL- Narzędzia niezbędne do montażu (nie dostarczone przez producenta)/ DE- Für die Montage notwendige Werkzeuge (nicht vom Hersteller mitgeliefert)/ EN- Tools required for assembly (not provided by the manufacturer)/ CZ- Nástroje nezbytné pro montáž (nejsou dodávány výrobcem)/ HR- Alati potreban za montažu (nije osiguran od strane proizvođača)/ HU- Az összeszereléshez szükséges (a gyártó által nem szállított) szerszámok/ SK- Nástroje potrebné na montáž (nedodávané výrobcom)

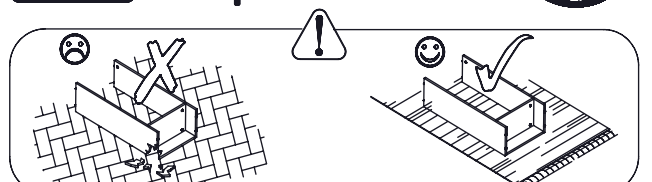

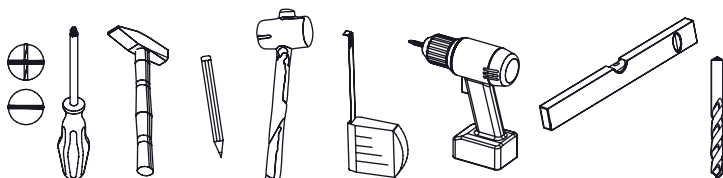

PL - UWAGA!

W przypadku reklamacji prosimy o podanie numeru serii znajdującego się na kartonie. W związku z tym prosimy o zachowanie opakowań do momentu zmontowania mebla. W przypadku stwierdzenia uszkodzenia któregoś z elementów, prosimy nie montować modułu, którego częścią jest dany element.

DE - HINWEIS!

Im Falle einer Reklamation geben Sie bitte die Seriennummer, die sich auf der Verpackung befindet. Daher bitten wir Sie immer die Verpackung solange aufzubewahren, bis die Möbelstücke vollständig montiert sind. Sollten Schäden an Einzelteilen auftreten, bitte sehen Sie von der Montage des Moduls ab.

EN - ATTENTION!

In case of claim please give us series number which you can find on the box. Thereupon please keep the package until montage of furniture is done. In case verified damage any of elements, please do not mount module, which is a parts of particular element.

CZ - POZOR!

Při reklamaci prosíme o uvedení čísla šarže, které se nachází na obale. V souvislosti s tímto prosíme o uchování obalů do okamžiku složení nábytku. V případě poškození některého z dílů, prosíme neskládat model, jehož součástí poškozený díl je.

HR - PAŽNJA!

U slučaju reklamacije, molimo Vas da nam date serijski broj koji možete pronaći na ambalaži. Molimo Vas da zadržite ambalažu sve dok nije kompletna montaža proizvoda. Ukoliko je uočeno oštećenje bilo kojeg elementa, molim Vas da ne montirate oštećeni dio.

HU - FIGYELEM!

A bútor összeszereléséig kérjük őrizze meg a csomagolást, mivel reklamáció esetén a kartonon található szériaszámot kell megadni. Amennyiben észreveszi, hogy valamelyik bútorelem sérült kérjük ne folytassa az összeszerelését a modulnak melynek része az adott elem.





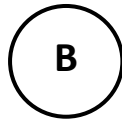
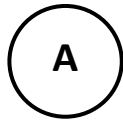
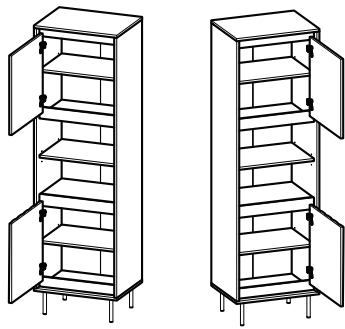



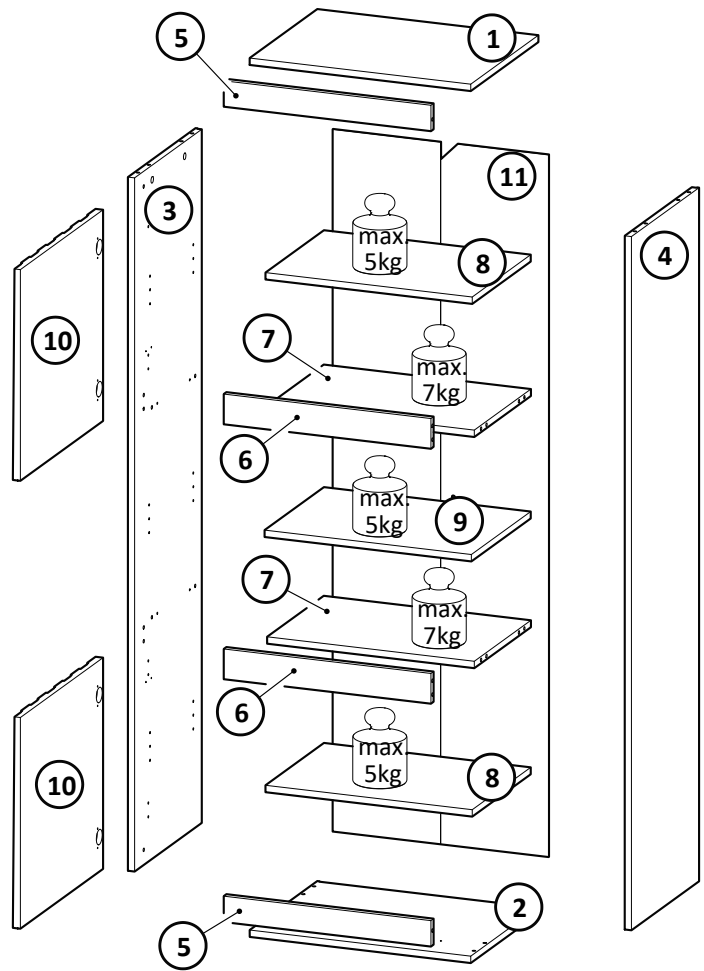





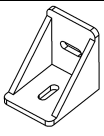



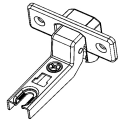

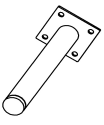
SK - POZOR!

V prípade sťažnosti uveďte číslo šarže na balení. Balenie preto uschovajte, kým nezostavíte nábytok. V prípade poškodenia niektorého z komponentov, nemontujte modul, ktorého je prvok súčasťou.

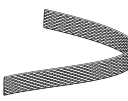

Nr	Xmm	Ymm	Zmm	x
1	528	400	16	1
2	528	400	16	1
3	1606	400	16	1
4	1606	400	16	1
5	495	60	16	2
6	495	70	16	2
7	495	335	16	2
8	494	346	16	2
9	494	351	16	1
10	489	489	18	2
11	516	1626	2,5	1

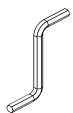
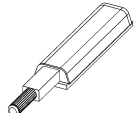

I20  12x Ø4/Ø17	K5  12x 34mm	K1  12x Ø15x12	B1  28x Ø8x35	A1  4x Ø7x50	M33  4x 37x37x3
G22  8x Ø4x16	W4  60x	D4  4x PZ350D	C4  4x Z350D	G34  4x 3,5x16	P67  4x h150
G4  16x 4x16	F2  12x Ø5	S26  2x Ø6/16	J24  1x L150	G17  1x 4x45	G37  1x Ø4x13
U6  1x Ø8x40	W2  1x 4mm	L21  2x	G5  8x 4x13		

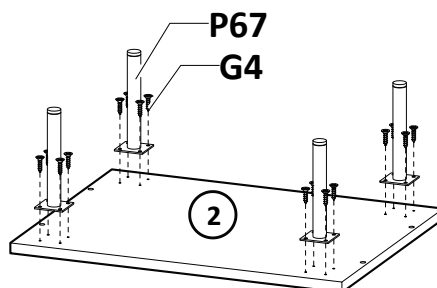
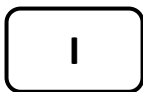

II

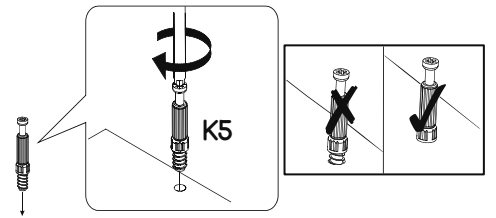
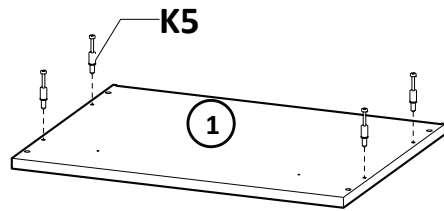

III

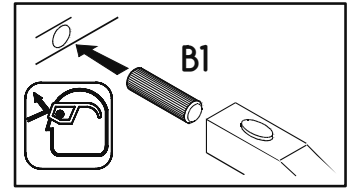
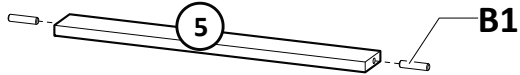

X2

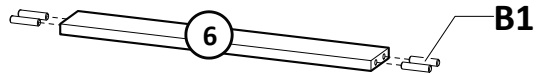

IV

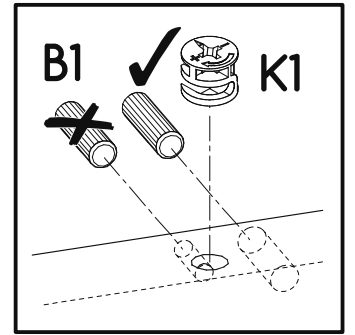
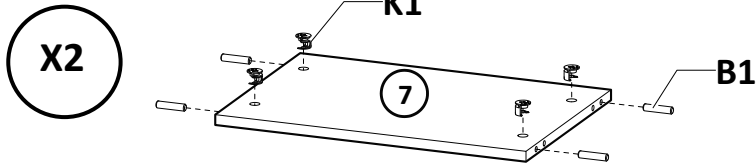

V

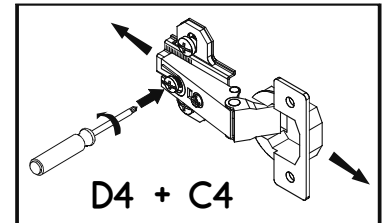
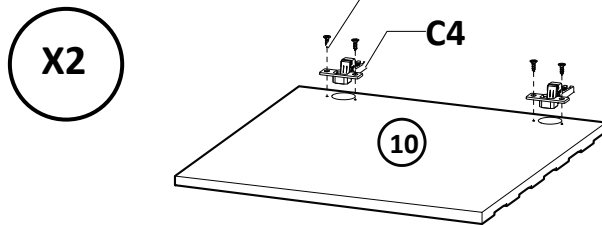

VI

A

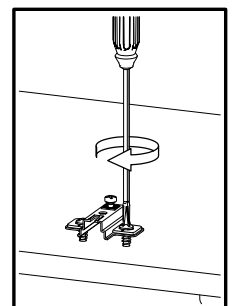
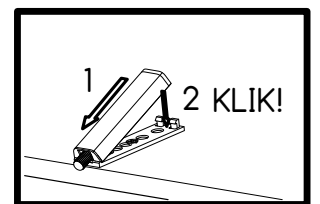
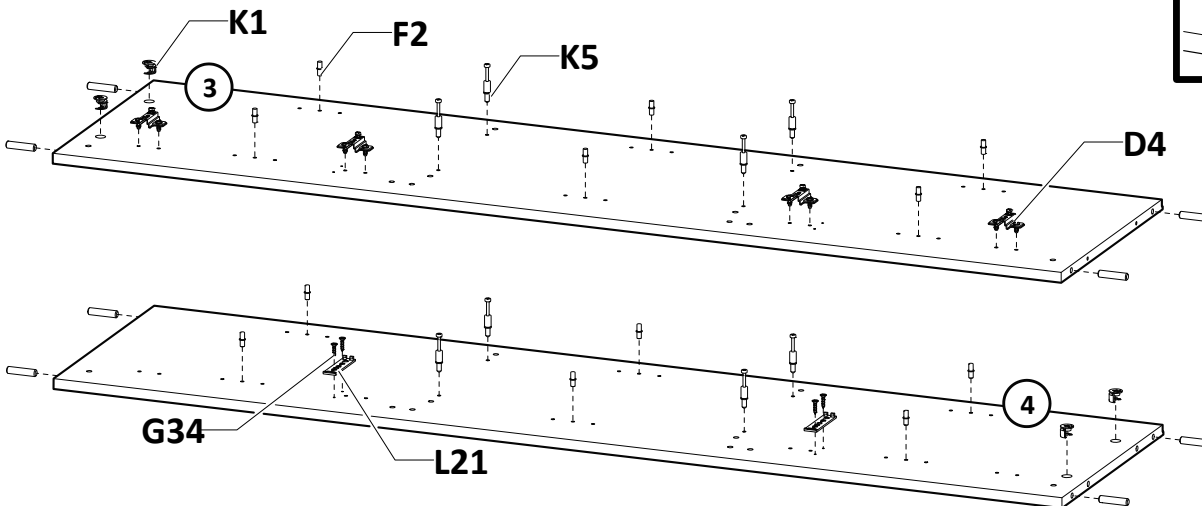

VI

B

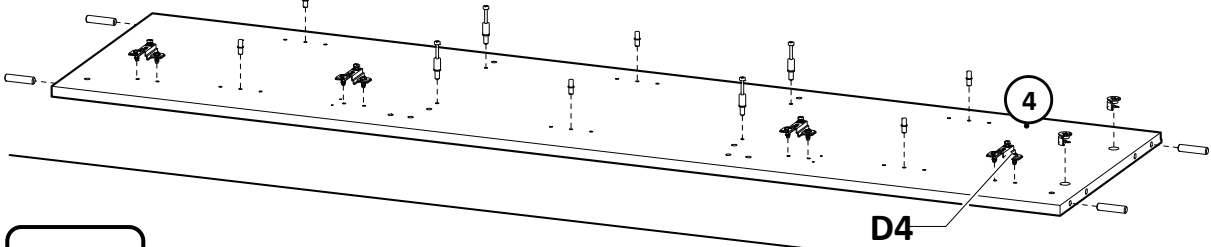
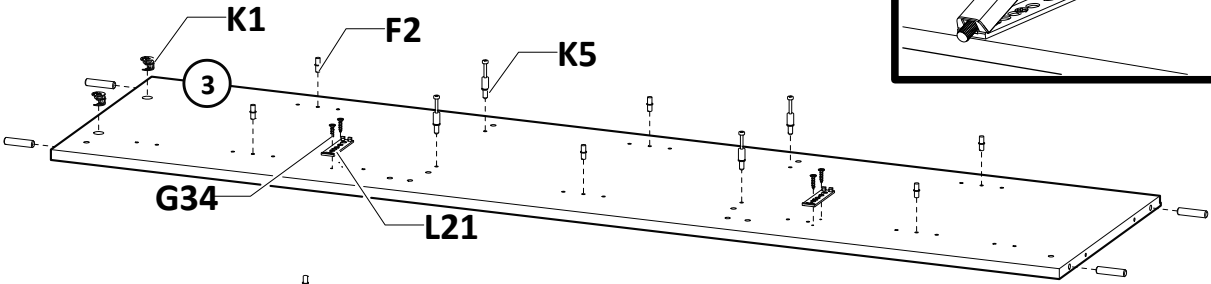
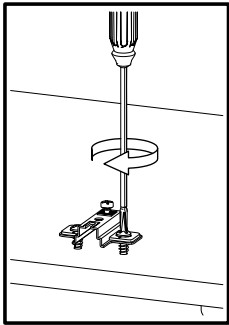
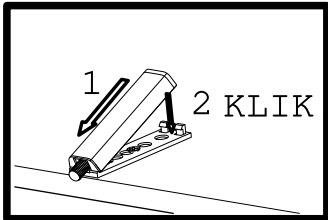

VII

i

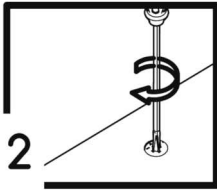
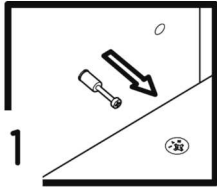
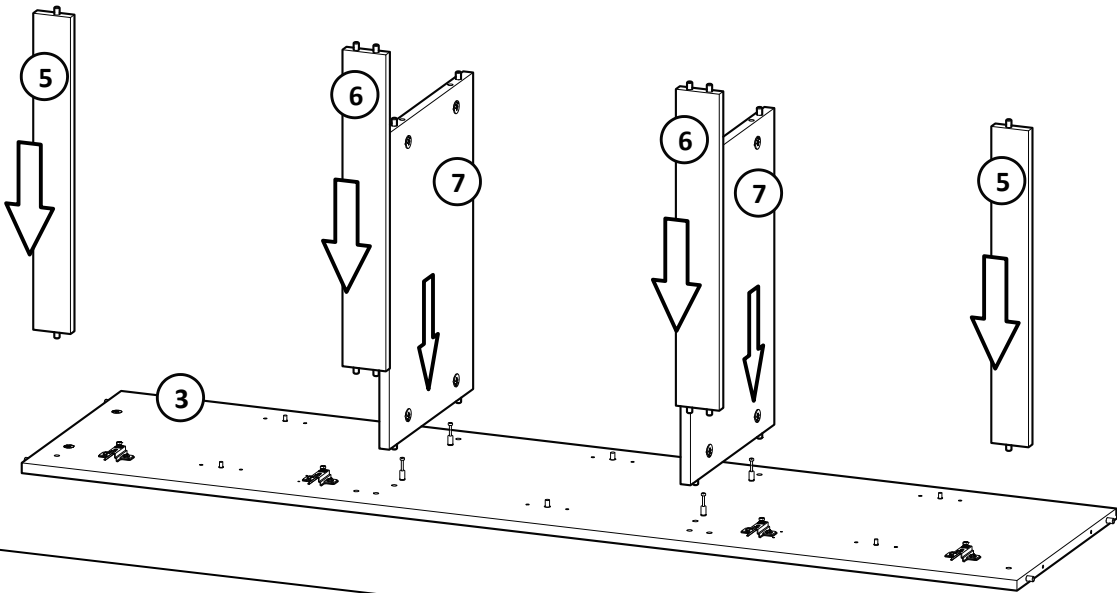

VIII

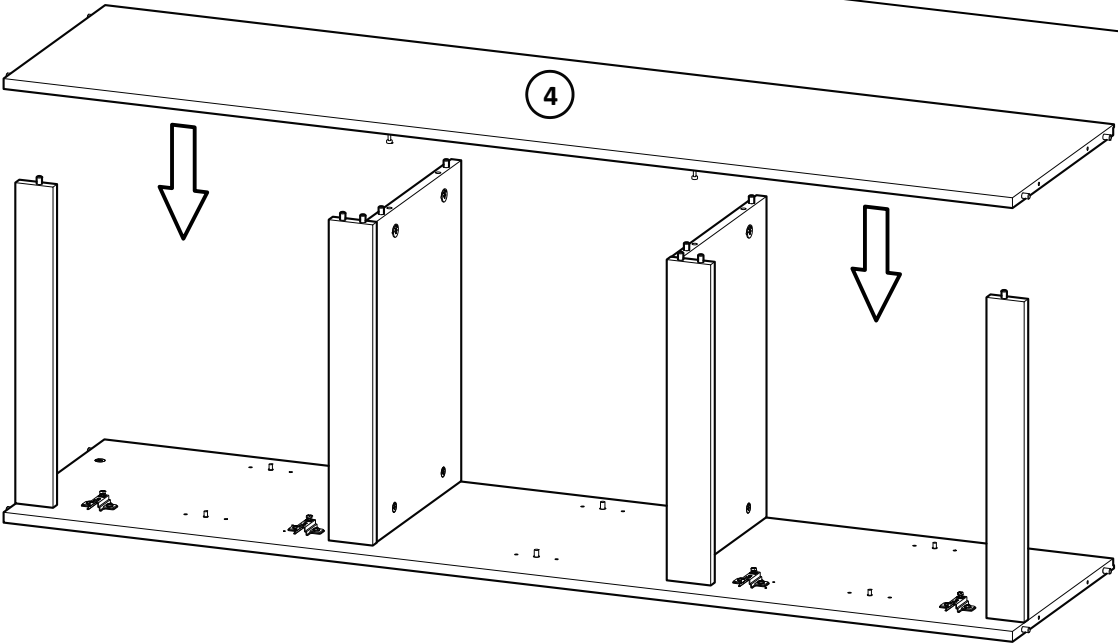

IX

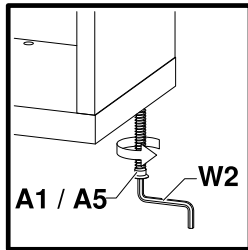
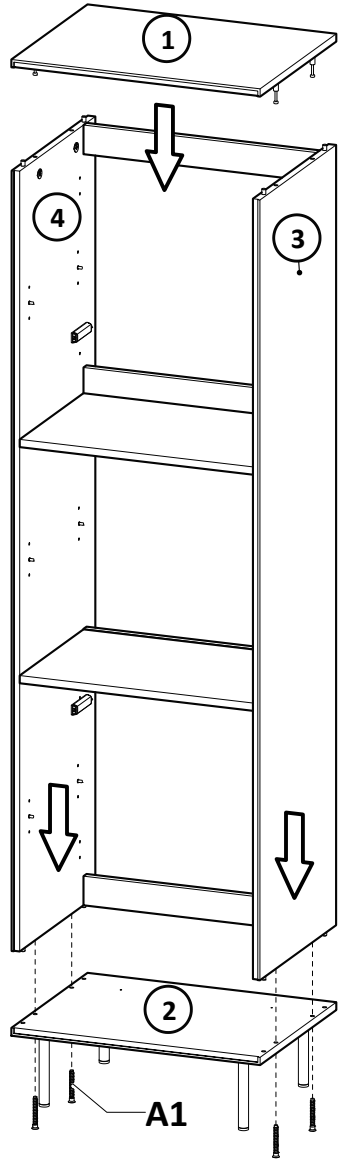

X

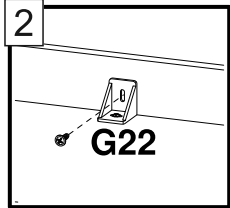
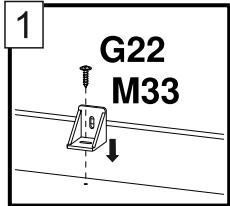
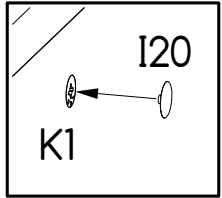
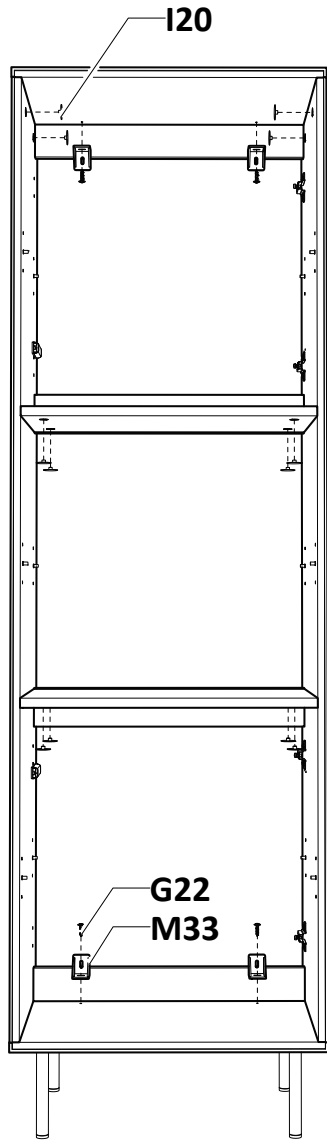

XI

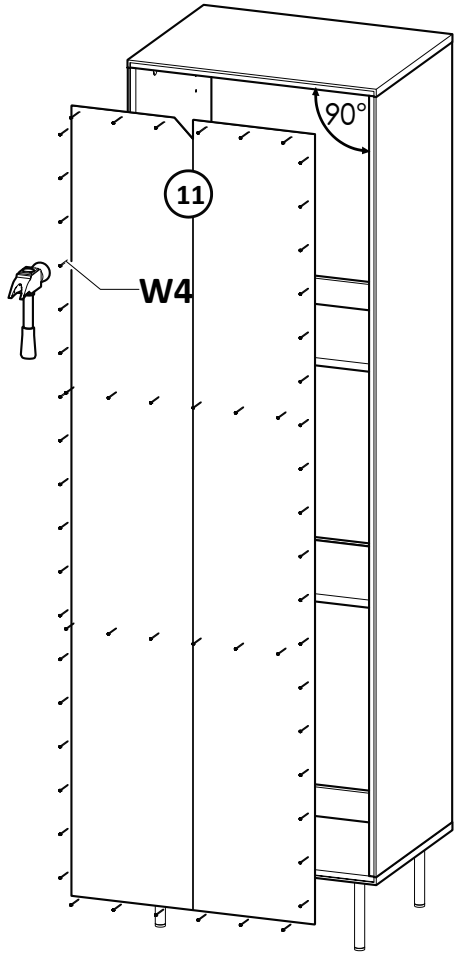

XII

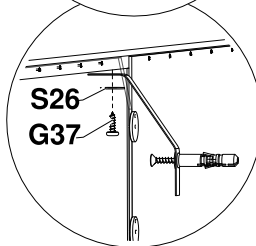
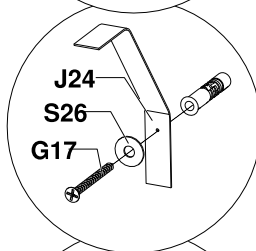
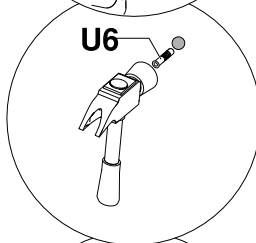
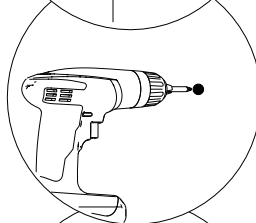
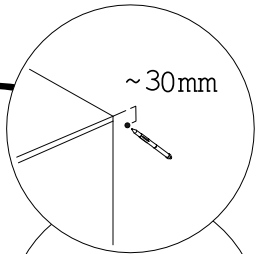
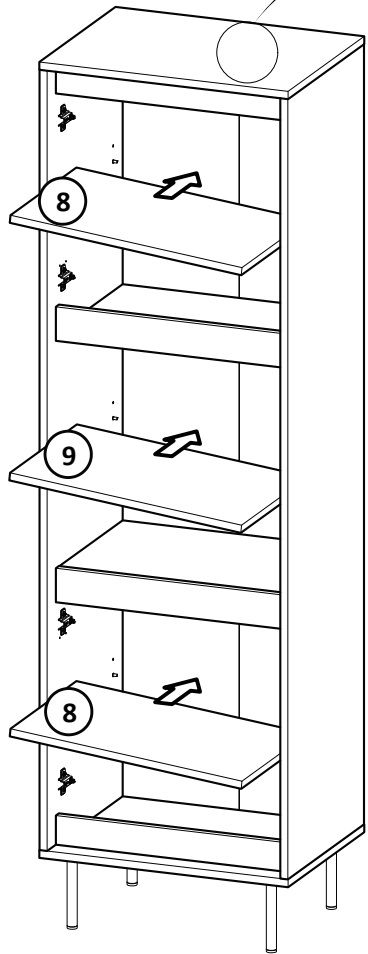

A

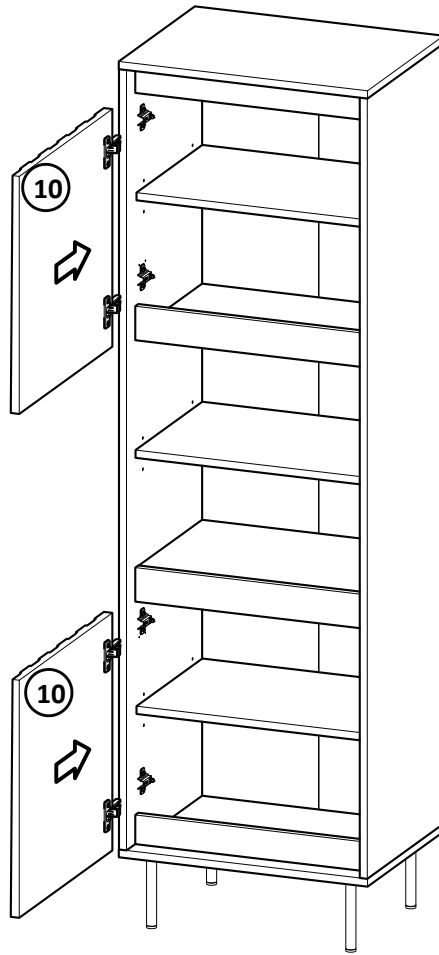

XIII

B

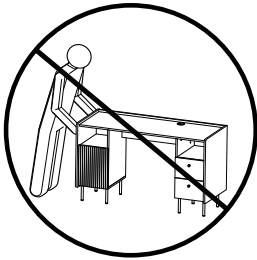
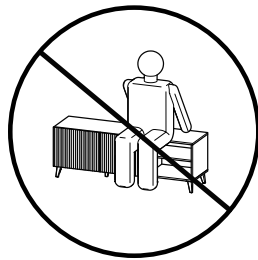
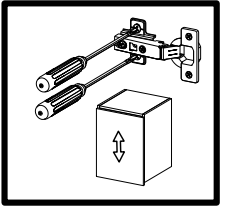
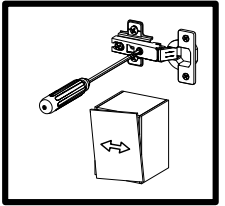
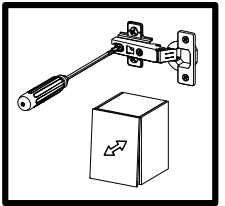
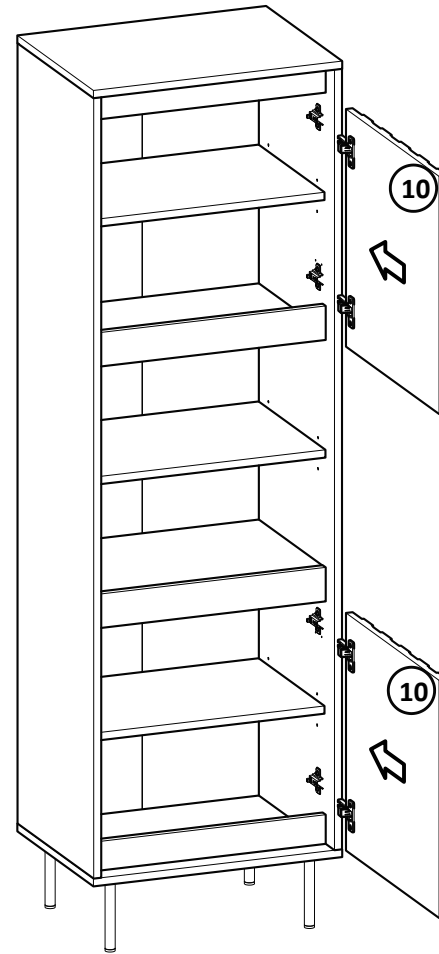

Claim your extended 90 day product warranty by registering your product at

**ATTENTION: DO NOT RETURN THIS PRODUCT!!!
PLEASE READ THE FOLLOWING!!!**

FOR REPLACEMENT/MISSING PARTS:

**FOR INSTRUCTION/ASSEMBLY MANUALS
AND VIDEOS:**

ALL OTHER INQUIRIES:

**IF YOU ARE MISSING PARTS OR YOUR
PRODUCT ARRIVED DAMAGED:**

Replacement parts are shipped out in one business day. You will receive a tracking number via email once your parts request has been processed.

**IF YOU ARE MISSING AN INSTRUCTION
MANUAL OR NEED ASSEMBLY HELP:**

**NOTICE REGARDING HIGH GLOSS
PROTECTIVE FOIL AND PRODUCT CARE:**

After removing the protective foil from the gloss fronts, the acrylic surface of the boards is still soft and easy to scratch. With air contact, the hygroscopic acrylic layer hardens, and the board becomes more resistant to scratches. It takes approximately 48 hours for the acrylic layer of the board to fully harden.

**DO NOT CLEAN, WIPE, OR POLISH THE
ACRYLIC FRONTS FOR 48 HOURS AFTER
REMOVING THE PROTECTIVE FOIL!!!**

