

INSTRUCTION MANUAL

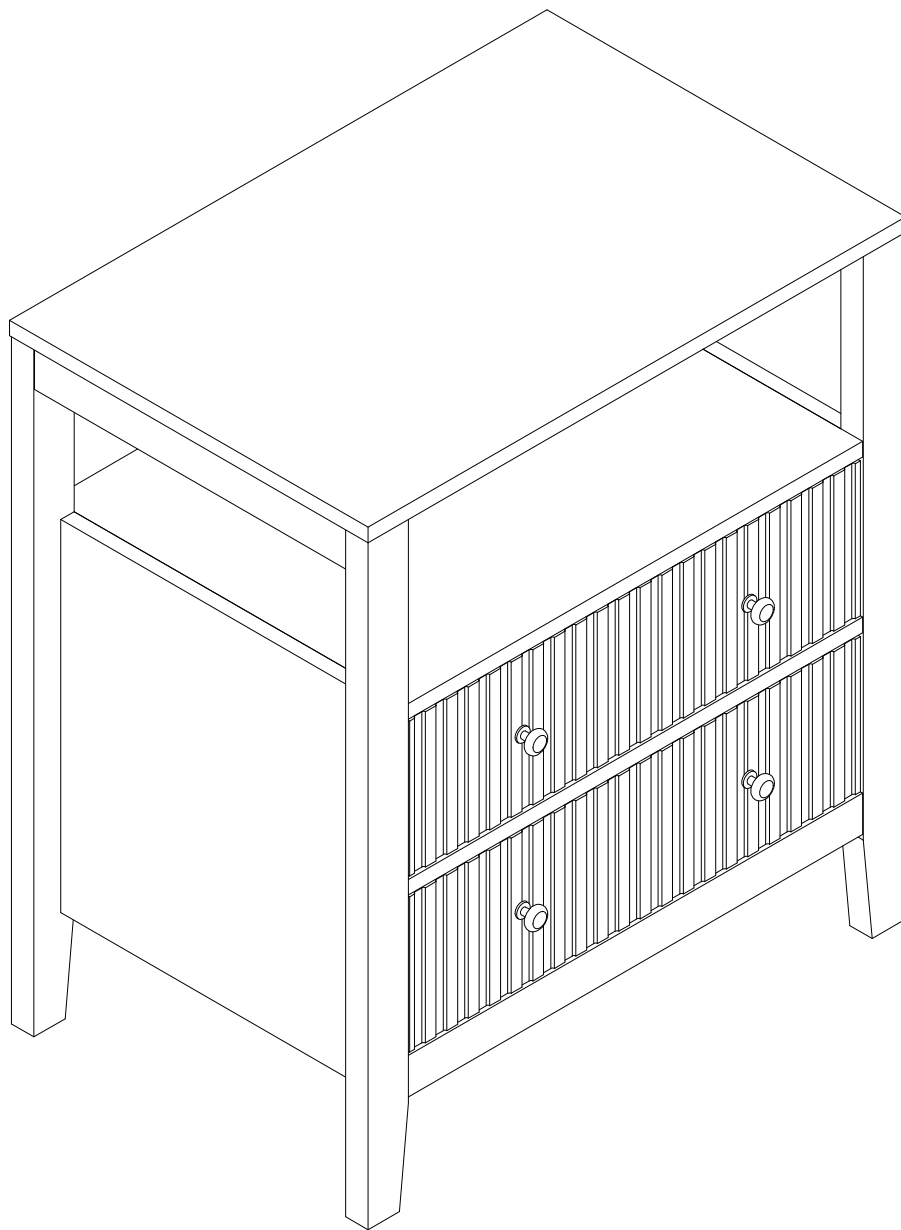

Contact Information

Question about your product? We're here to help. Contact us by:



Orders FAQ



Product Assembly



Product Inquiry



Chat Support



Returns & Refunds



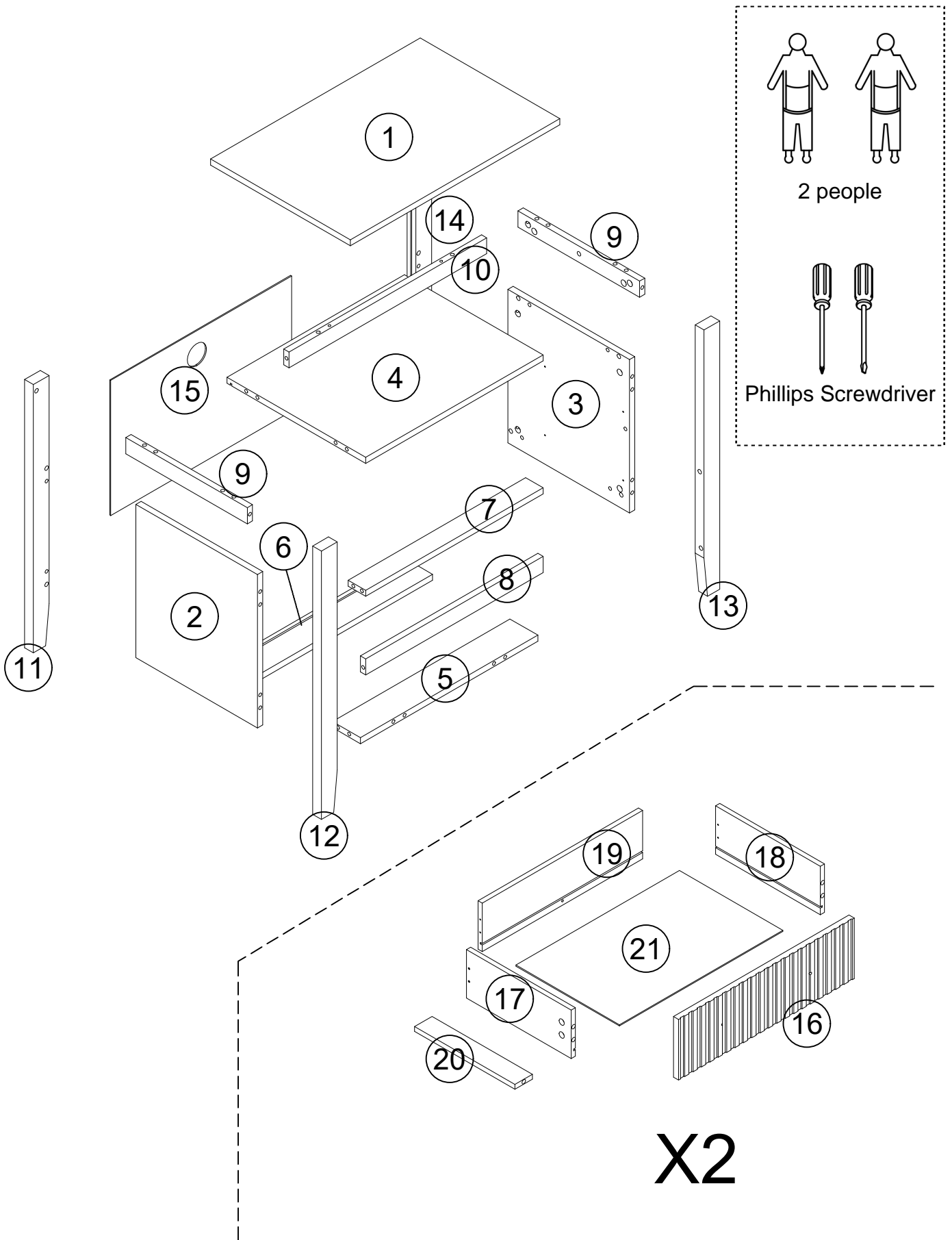

If you have any problems, please send your order number and photos to us. We will contact you within 24 hours and provide you with a satisfactory solution.

! NOTICE Please retain these instructions for future reference.



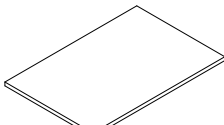
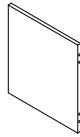
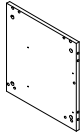
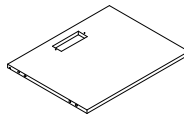
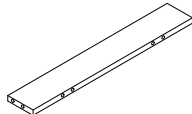
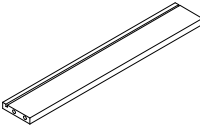
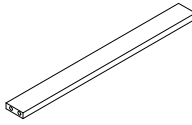
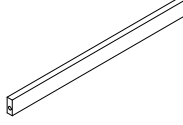
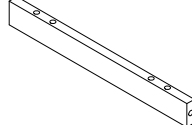
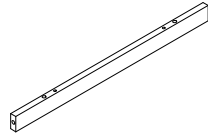



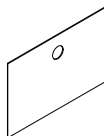
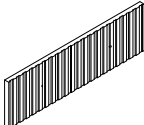
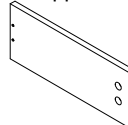
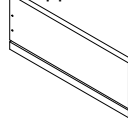
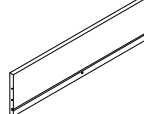
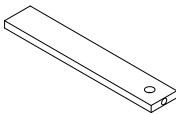
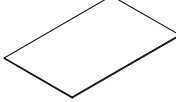



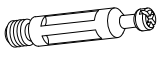

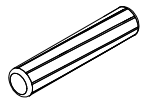
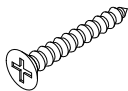
- Carefully unpack all the components and verify that all the necessary parts are included as listed in the packaging.
- Identify each component and refer to the provided assembly diagram or step-by-step instructions.
- Assemble the furniture in the order specified to ensure proper alignment and fit.
- Use the provided tools or recommended tools for assembly. Do not use excessive force when tightening screws or bolts.
- If any difficulties arise during assembly. Consult the troubleshooting section or contact our customer support.

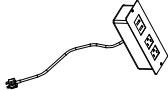
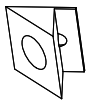

☰ PARTS LIST

<p>1 Roof panel</p>  <p>1PC</p>	<p>2 Left panel</p>  <p>1PC</p>	<p>3 Right panell</p>  <p>1PC</p>	<p>4 Middle panel</p>  <p>1PC</p>	<p>5 Front low pull bar</p>  <p>1PC</p>
<p>6 Rear low pull bar</p>  <p>1PC</p>	<p>7 Front pull handle</p>  <p>1PC</p>	<p>8 Front trim strip</p>  <p>1PC</p>	<p>9 Side skirting</p>  <p>2PCS</p>	<p>10 Support bar</p>  <p>1PC</p>
<p>11 Left hind leg</p>  <p>1PC</p>	<p>12 Left front leg</p>  <p>1PC</p>	<p>13 Right hind leg</p>  <p>1PC</p>	<p>14 Right front leg</p>  <p>1PC</p>	<p>15 Backplate</p>  <p>1PC</p>
<p>16 Drawer side panel</p>  <p>2PCS</p>	<p>17 Left side support</p>  <p>2PCS</p>	<p>18 Right side support</p>  <p>2PCS</p>	<p>19 Plug and block</p>  <p>2PCS</p>	<p>20 Support bar</p>  <p>2PCS</p>
<p>21 Bottom drawer</p>  <p>2PCS</p>				

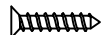
☰ HARDWARE LIST

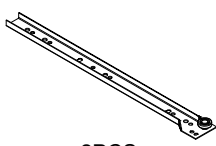
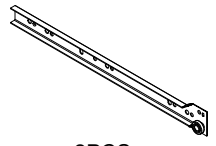
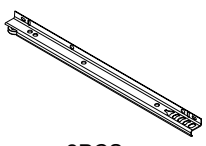
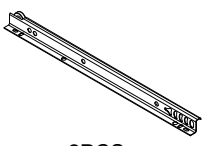
A1 Ø6x35mm Cam Bolt  44+1PCS	A2 Ø15x10mm Cam Lock  44+1PCS	B Ø8x30mm Dowel  26+1PCS	C Ø3.5x35mm Screw  10+1PCS	D Ø3.5x14mm Screw  26+2PCS
E1 Round Handle  4PCS	E2 M4x18mm Handle Bolt  4PCS	F Power strip  1PC	G Back Buckle  8PCS	H1 Anti-tip metal strip  2PCS
H2 Decorative cover  2PCS	H3 Ø3.5x14mm Screw  2PCS	H4 Ø3.5x35mm Screw  2PCS	H5 Plastic Expansion  2PCS	J Perfect Stickers  44PCS
CL Sliding Track  2PCS	CR Sliding Track  2PCS	DL Sliding Track  2PCS	DR Sliding Track  2PCS	



If you are missing any parts, please provide your order number and circle the part number. Send us a photo of this, and we will provide you with a satisfactory solution. Thank you.

STEP1

Please tighten the screws after completing all installation.

Por favor, apriete los tornillos después de instalar todo.

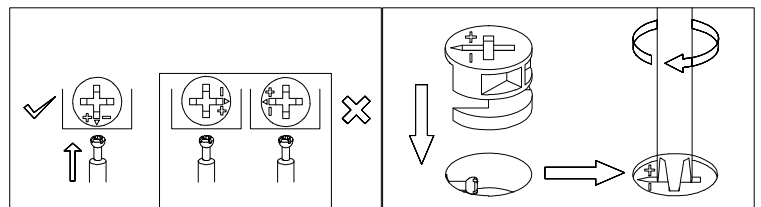
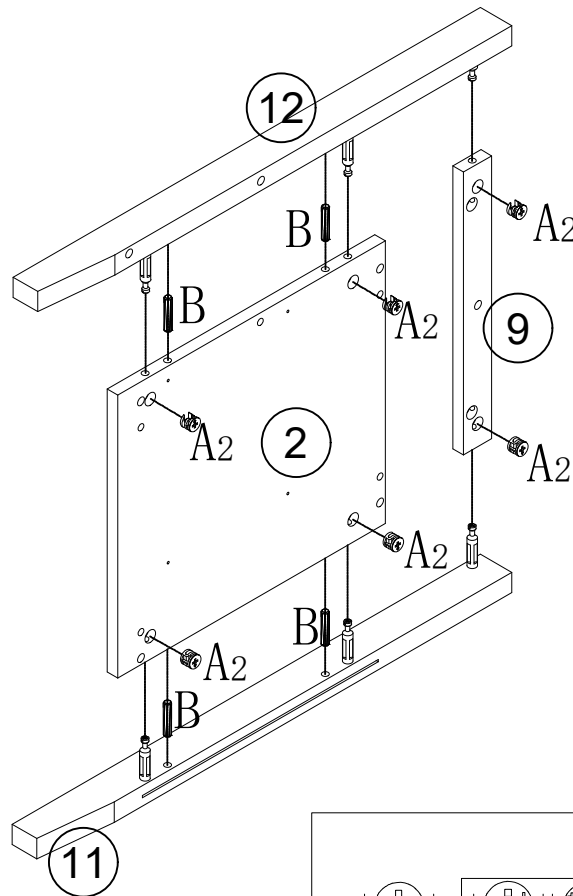
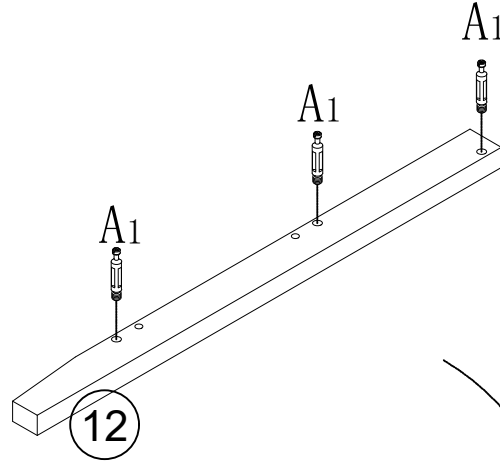
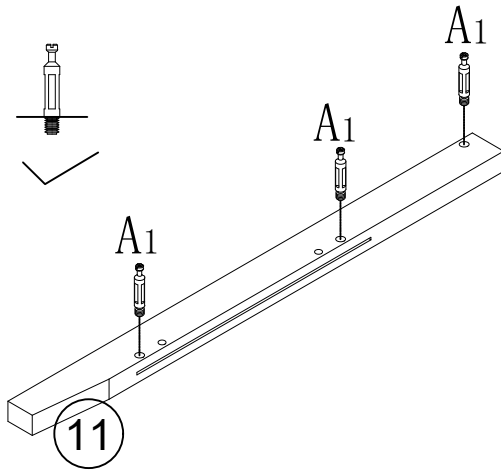
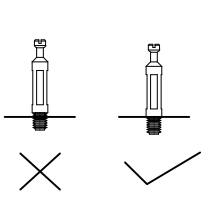
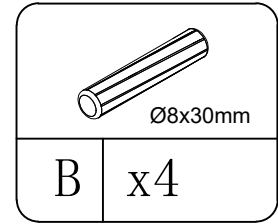
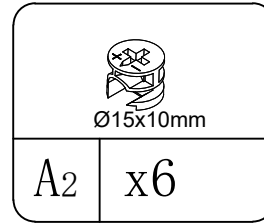
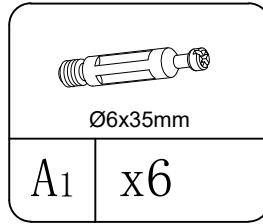
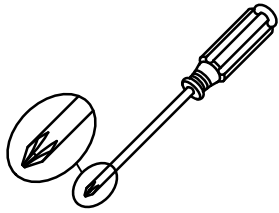

STEP2

Please tighten the screws after completing all installation.

Por favor, apriete los tornillos después de instalar todo.

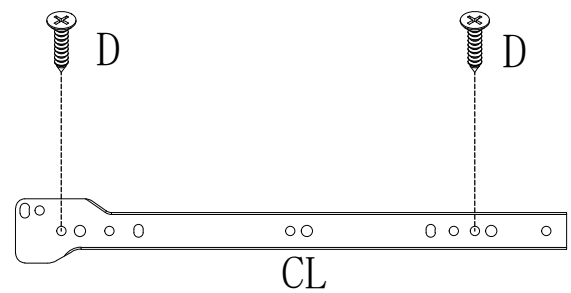
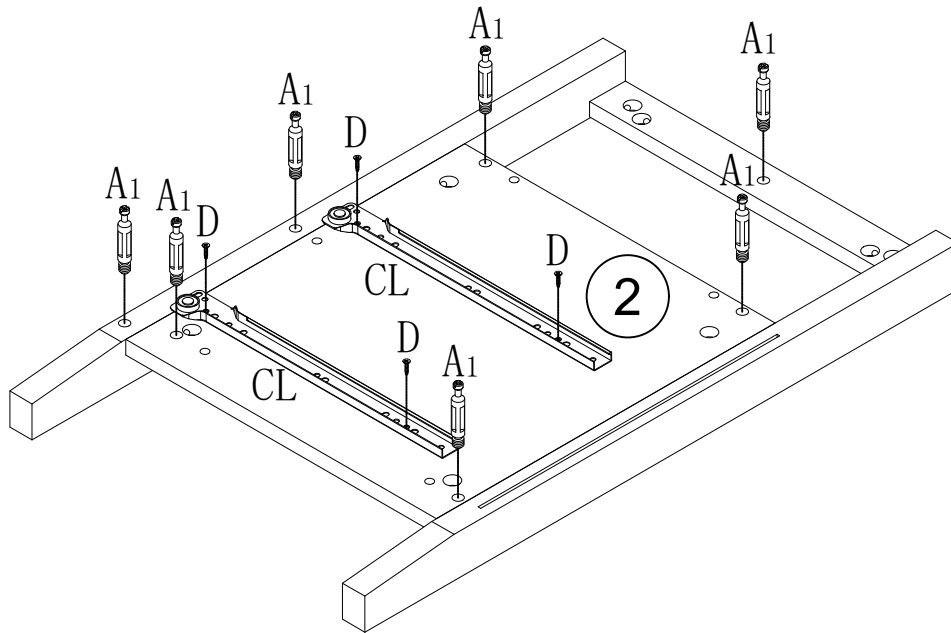
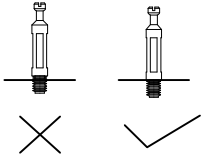
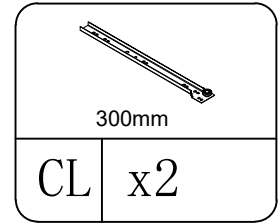
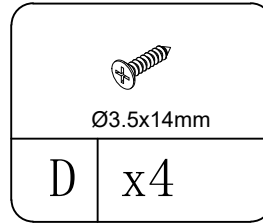
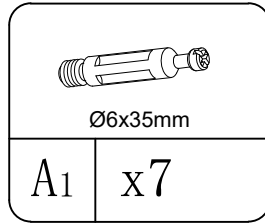
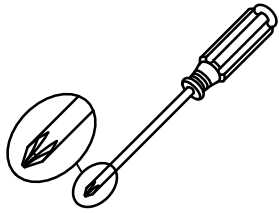

STEP3

Please tighten the screws after completing all installation.

Por favor, apriete los tornillos después de instalar todo.

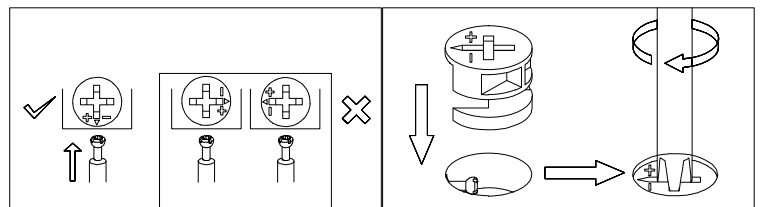
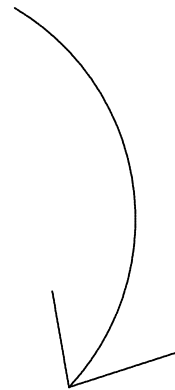
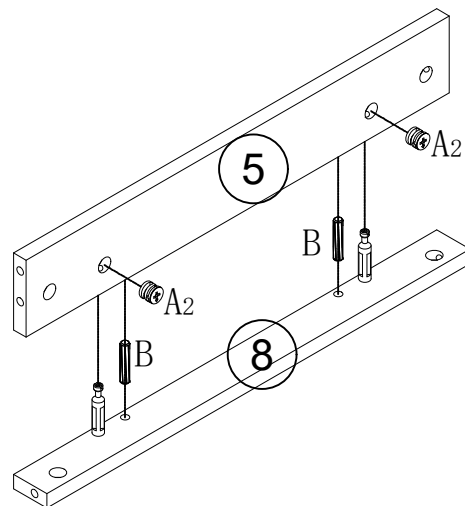
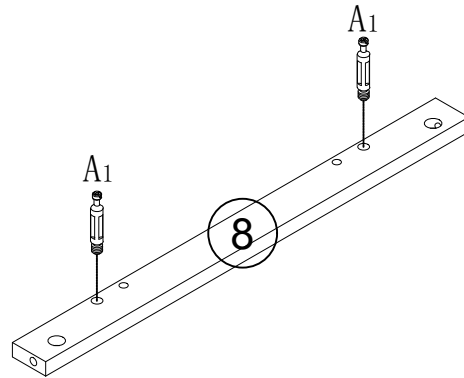
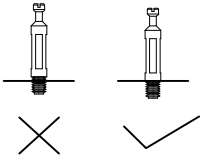
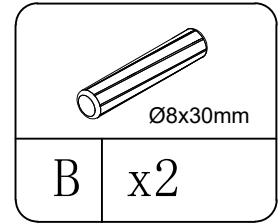
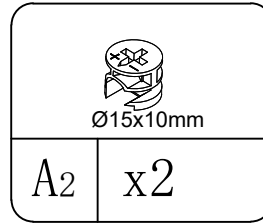
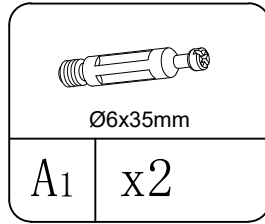
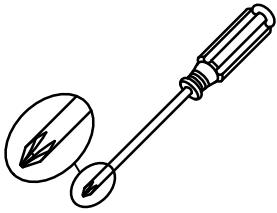

STEP4

Please tighten the screws after completing all installation.

Por favor, apriete los tornillos después de instalar todo.

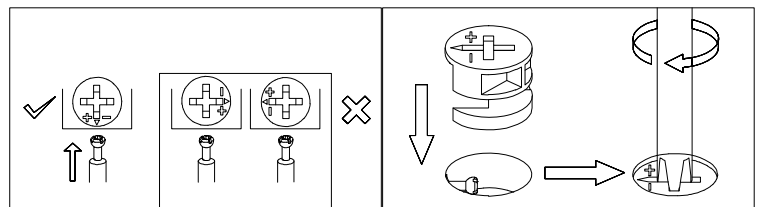
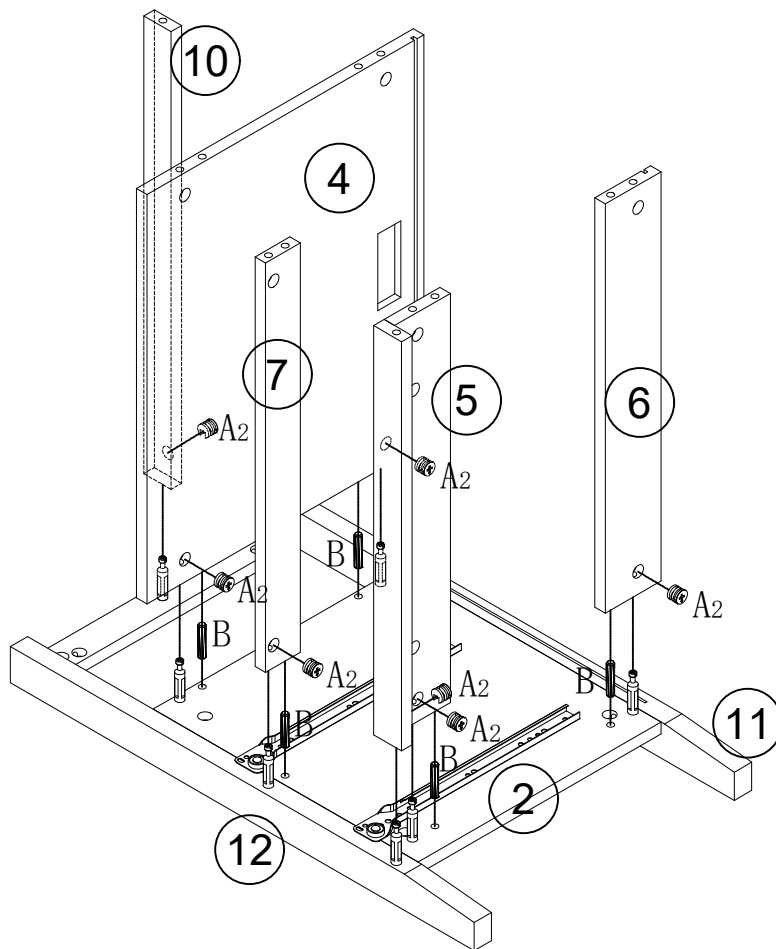
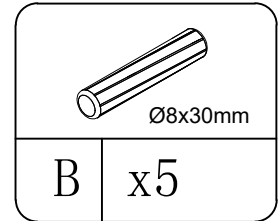
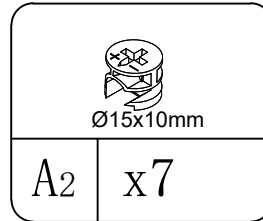
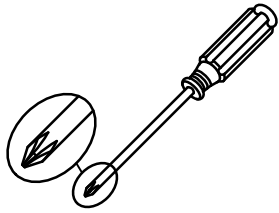

STEP5

Please tighten the screws after completing all installation.

Por favor, apriete los tornillos después de instalar todo.

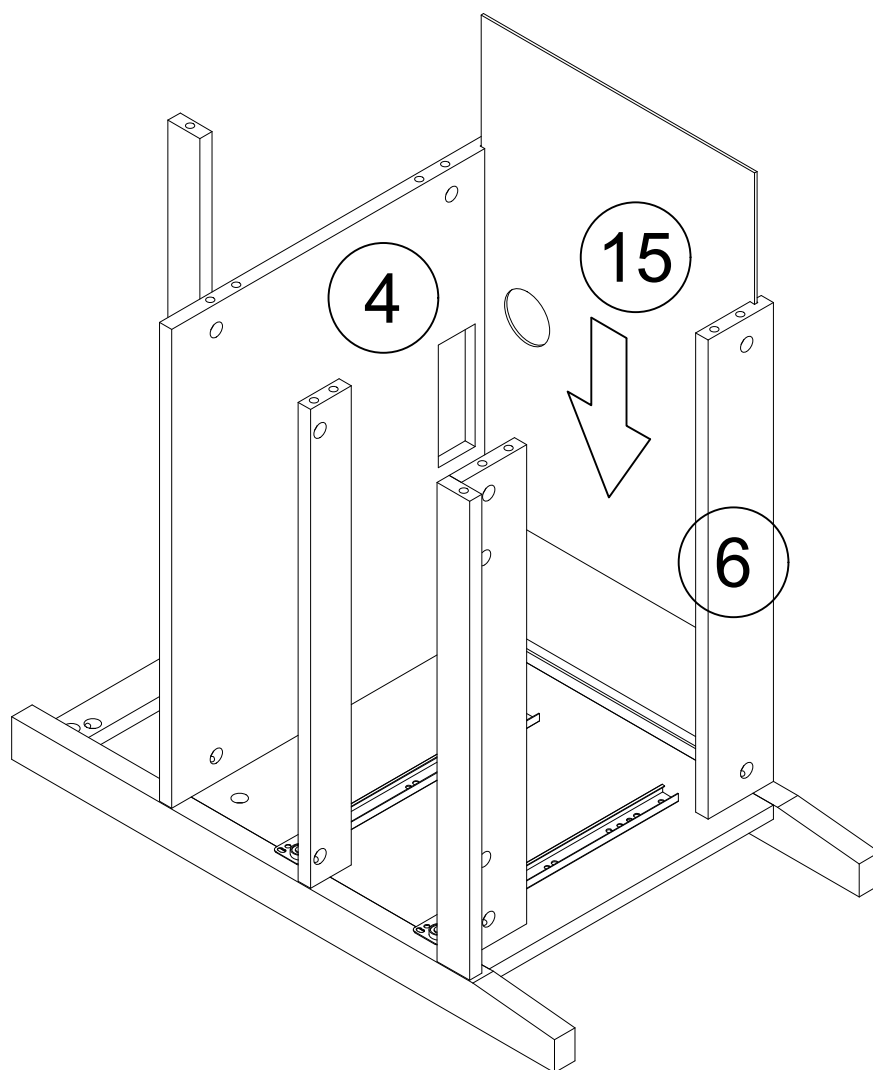

STEP6

Please tighten the screws after completing all installation.

Por favor, apriete los tornillos después de instalar todo.

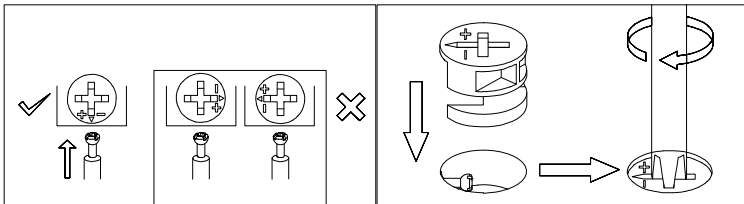
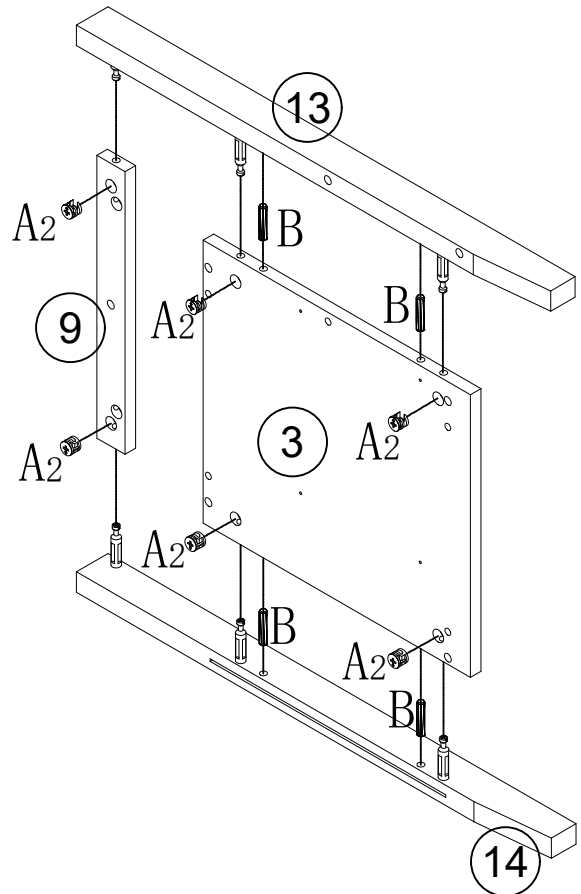
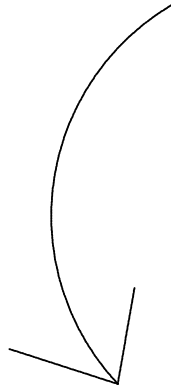
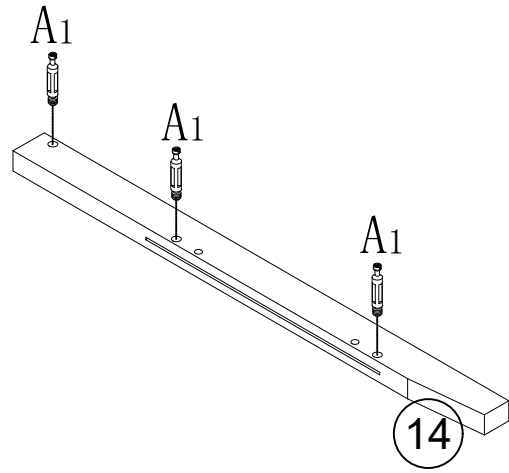
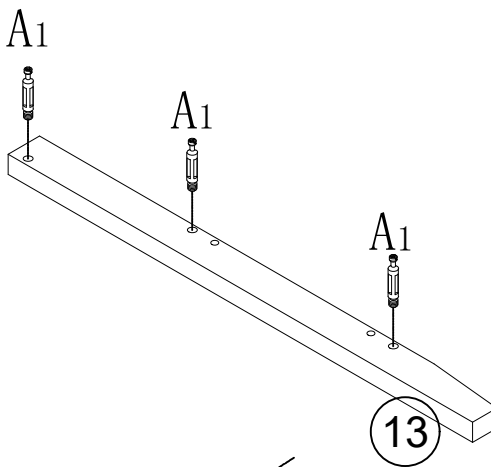
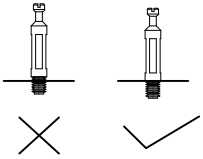
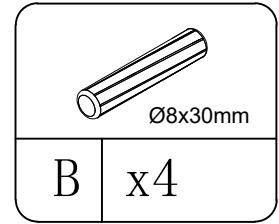
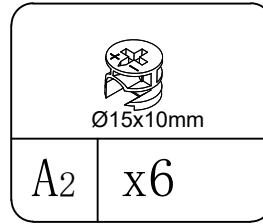
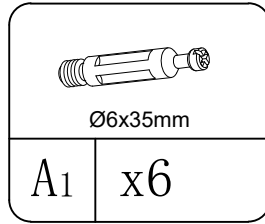
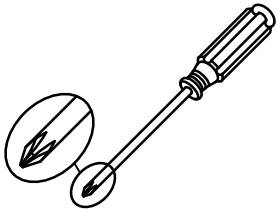

STEP7

Please tighten the screws after completing all installation.

Por favor, apriete los tornillos después de instalar todo.

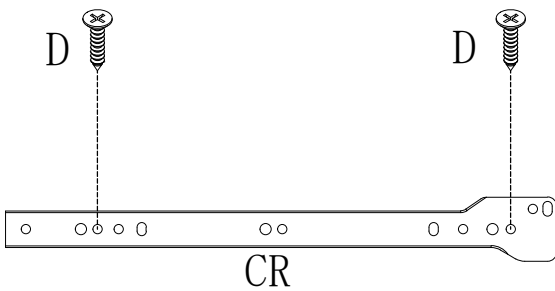
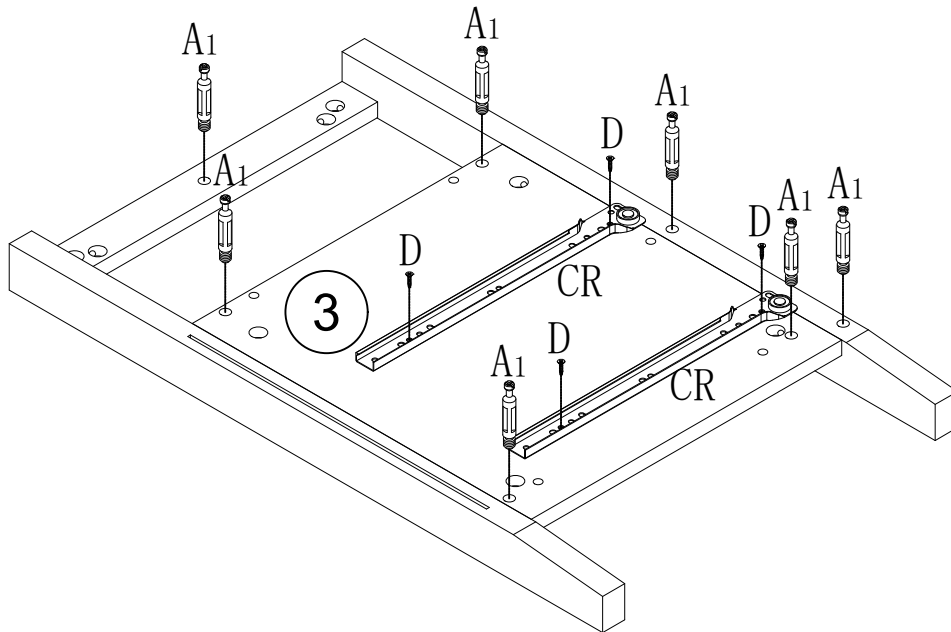
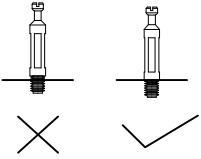
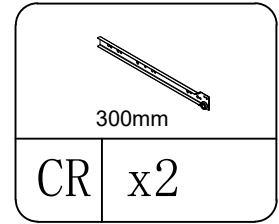
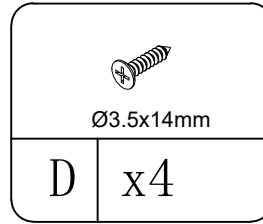
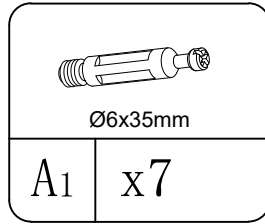
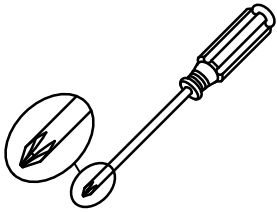

STEP8

Please tighten the screws after completing all installation.

Por favor, apriete los tornillos después de instalar todo.

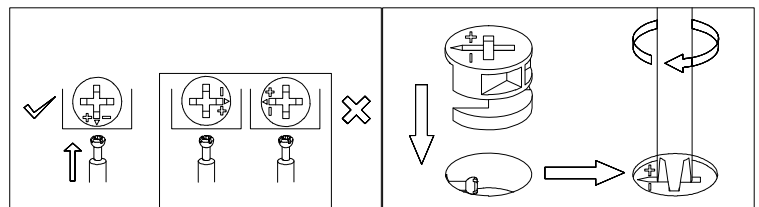
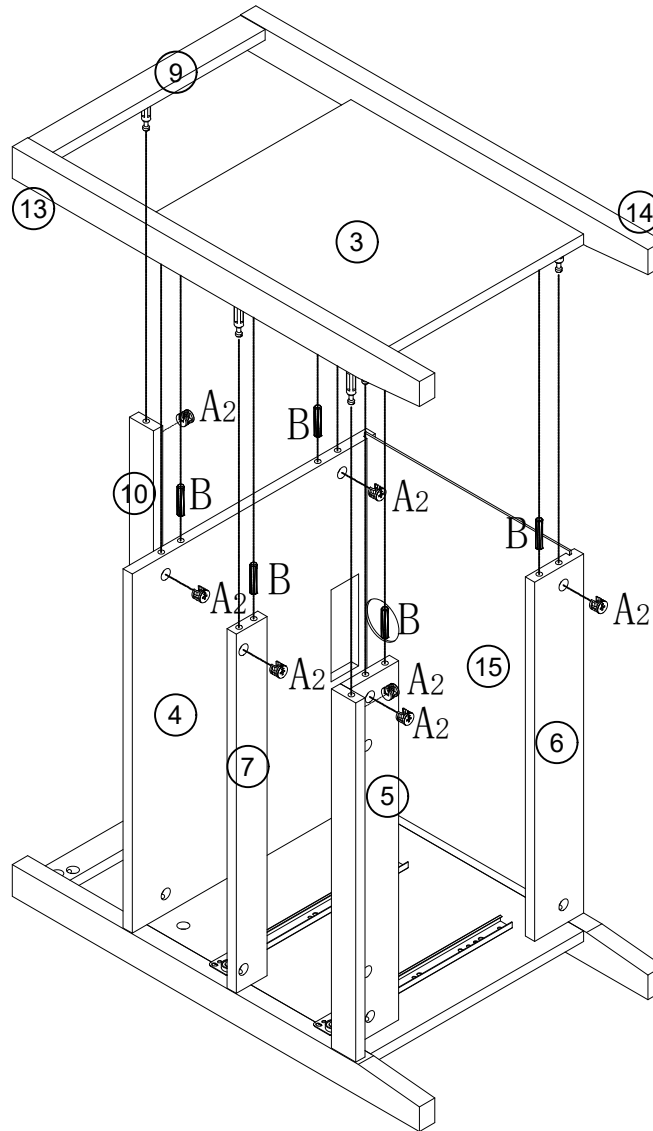
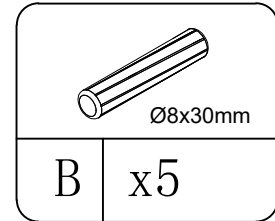
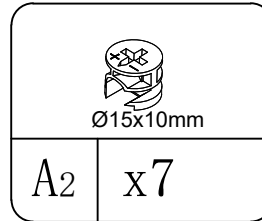
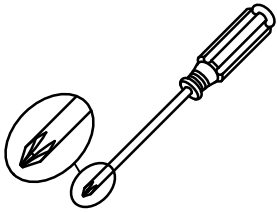

STEP9

Please tighten the screws after completing all installation.

Por favor, apriete los tornillos después de instalar todo.

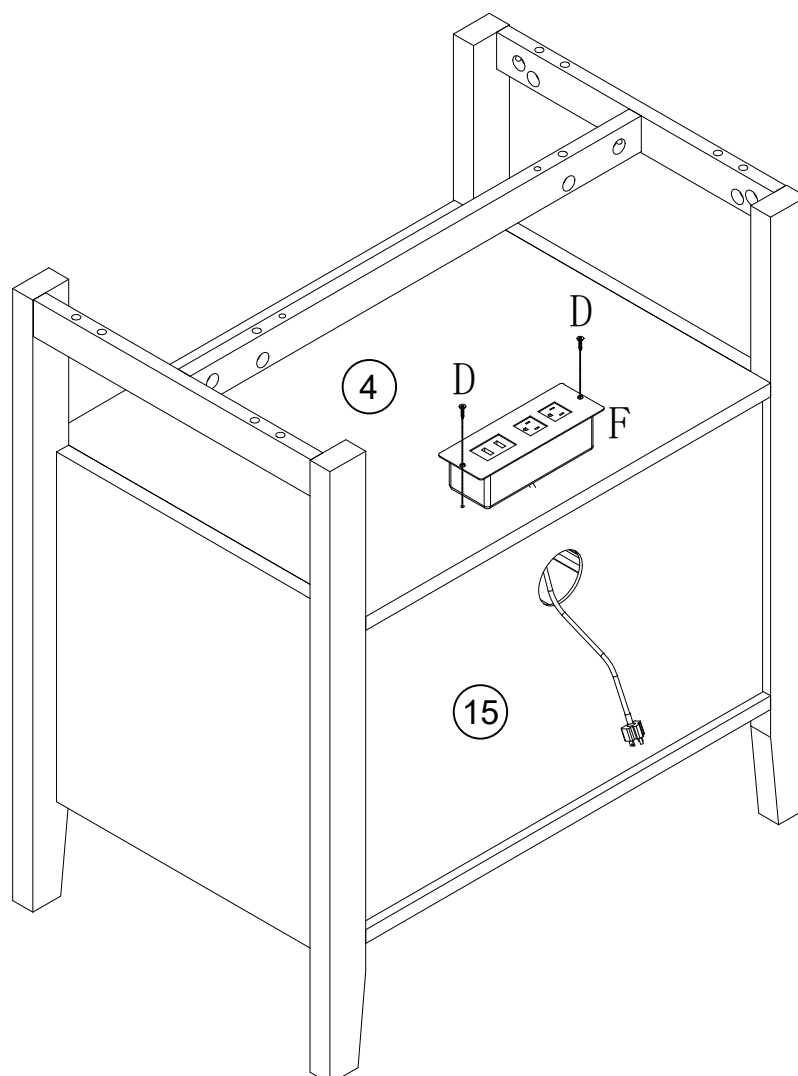
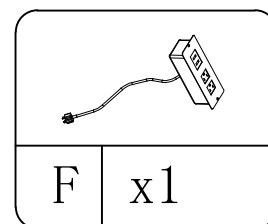
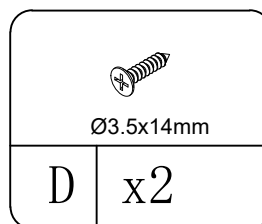
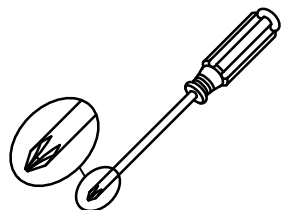

STEP10

Please tighten the screws after completing all installation.

Por favor, apriete los tornillos después de instalar todo.

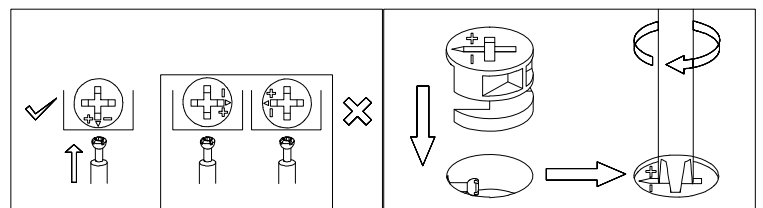
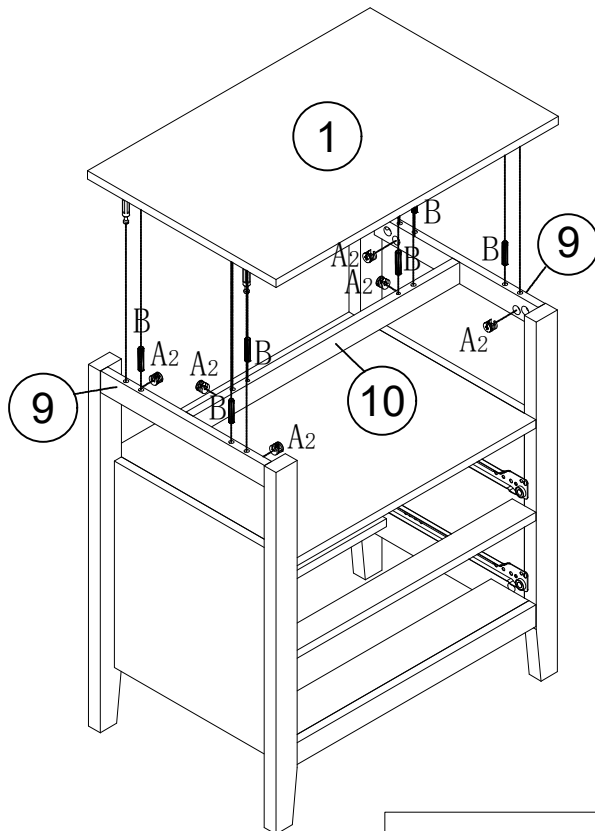
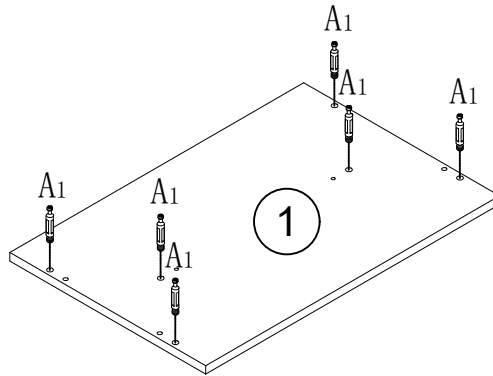
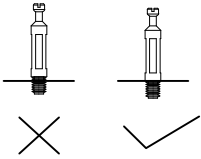
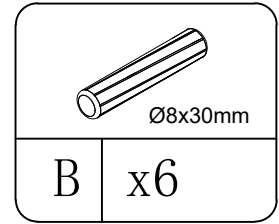
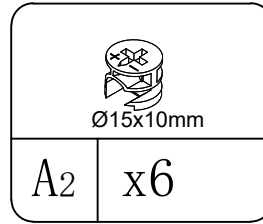
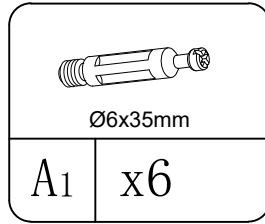
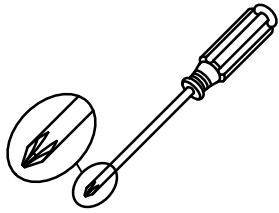

STEP11

Please tighten the screws after completing all installation.

Por favor, apriete los tornillos después de instalar todo.

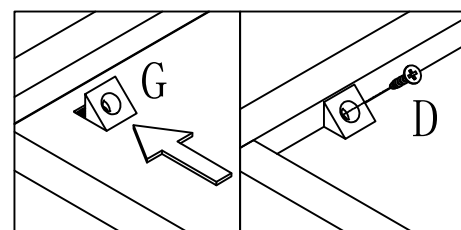
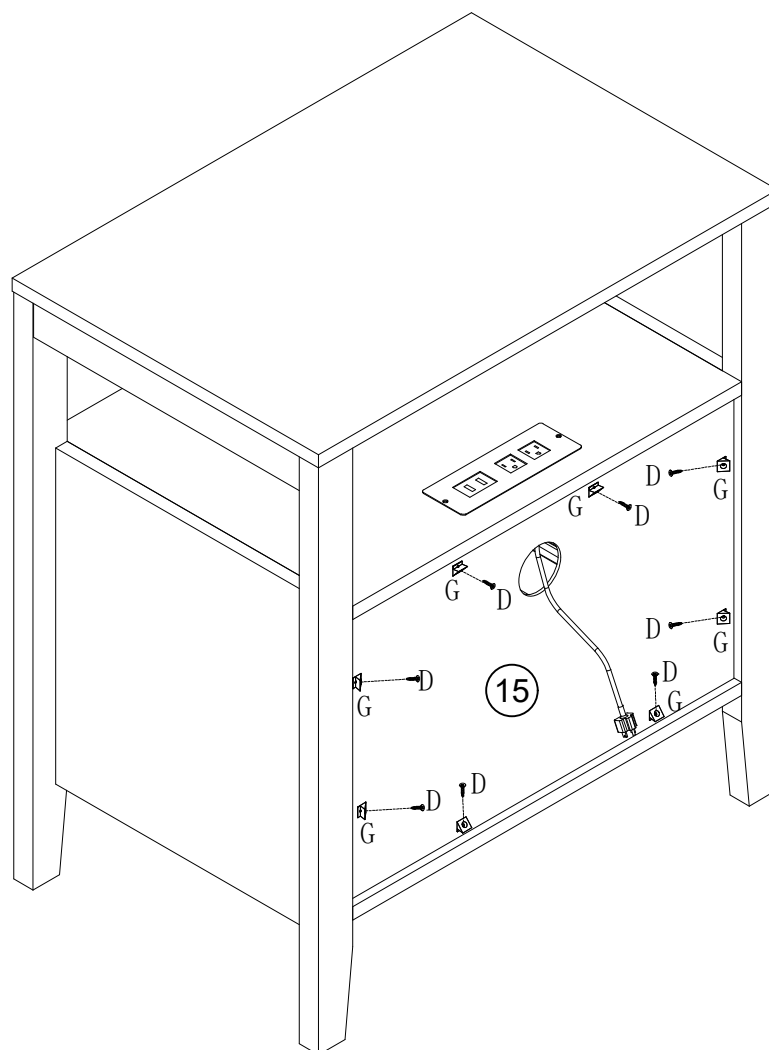
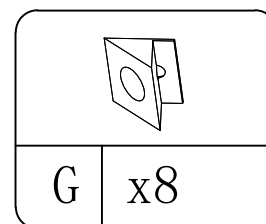
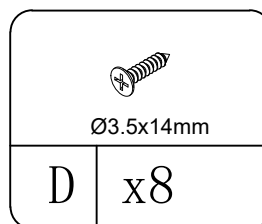
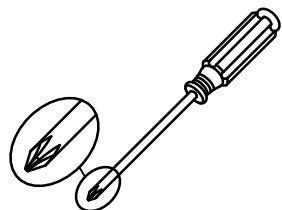

STEP12

Please tighten the screws after completing all installation.

Por favor, apriete los tornillos después de instalar todo.

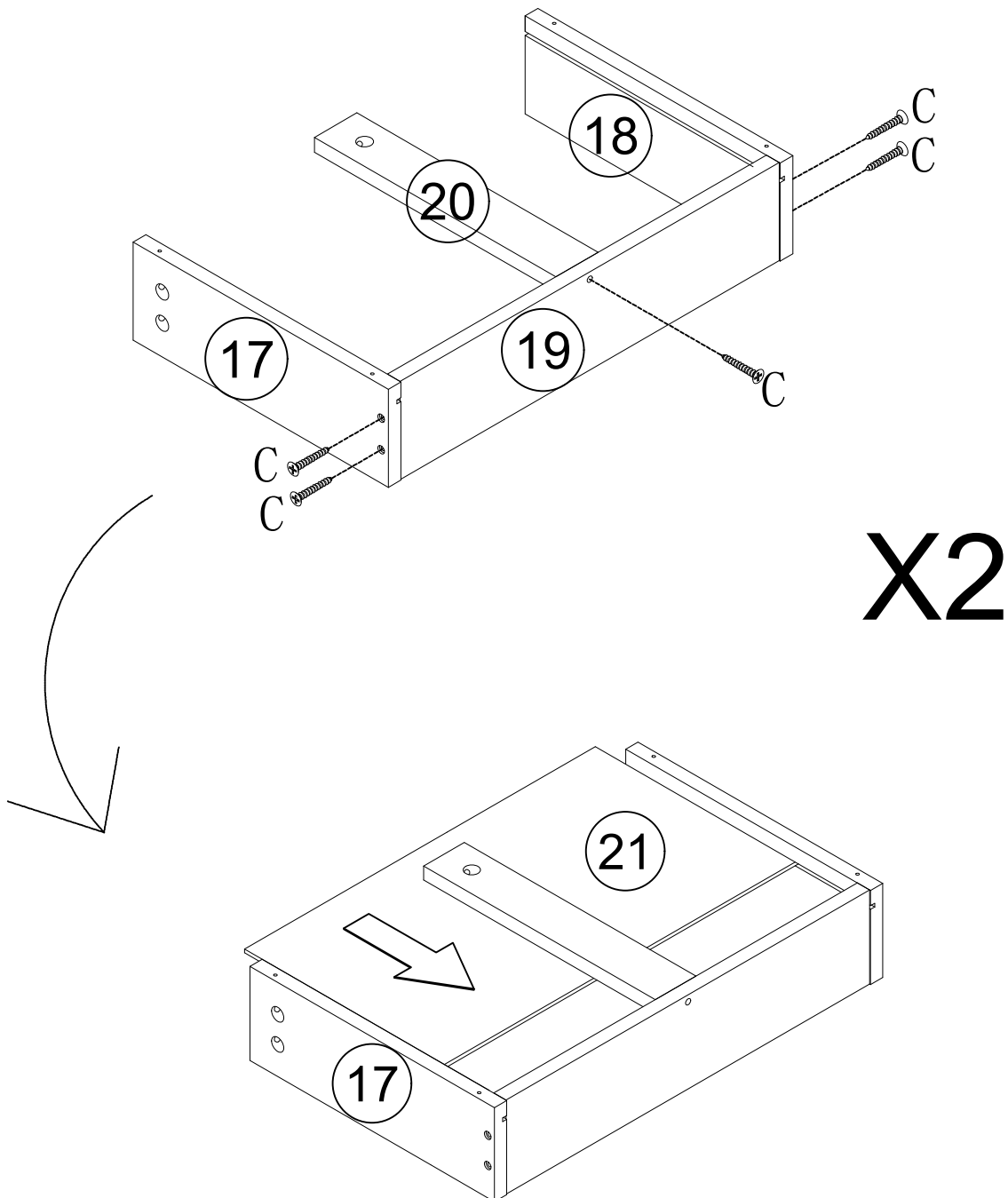
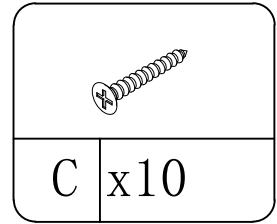
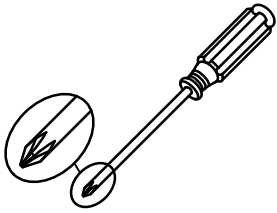

STEP13

Please tighten the screws after completing all installation.

Por favor, apriete los tornillos después de instalar todo.

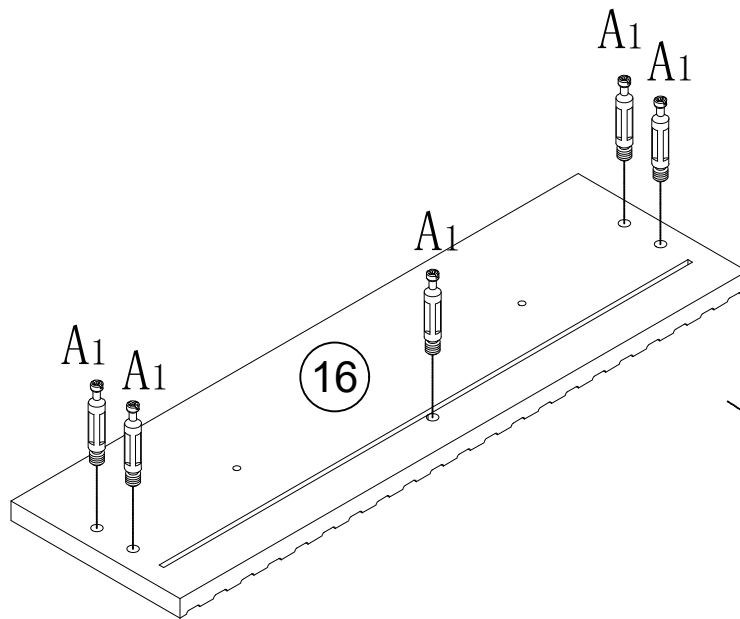
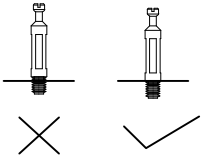
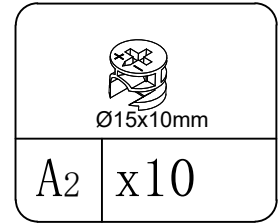
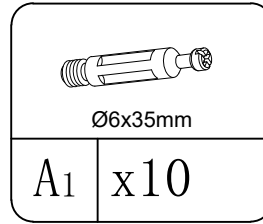
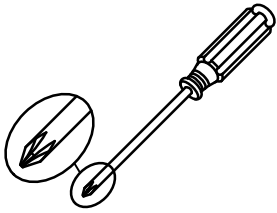

X2

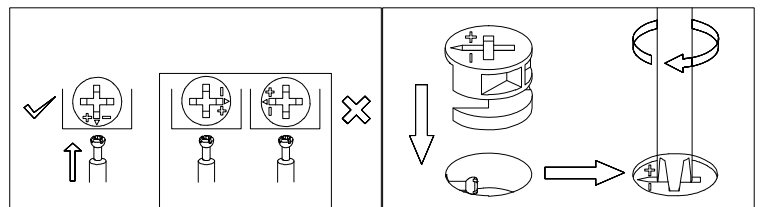
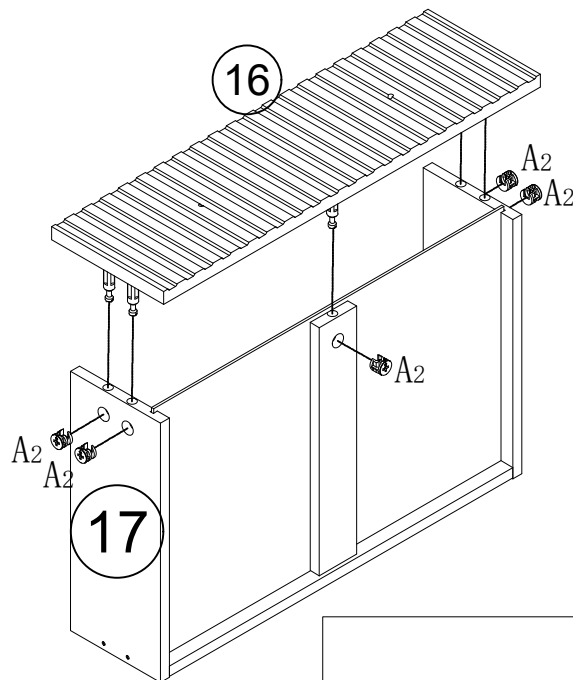

STEP14

Please tighten the screws after completing all installation.

Por favor, apriete los tornillos después de instalar todo.

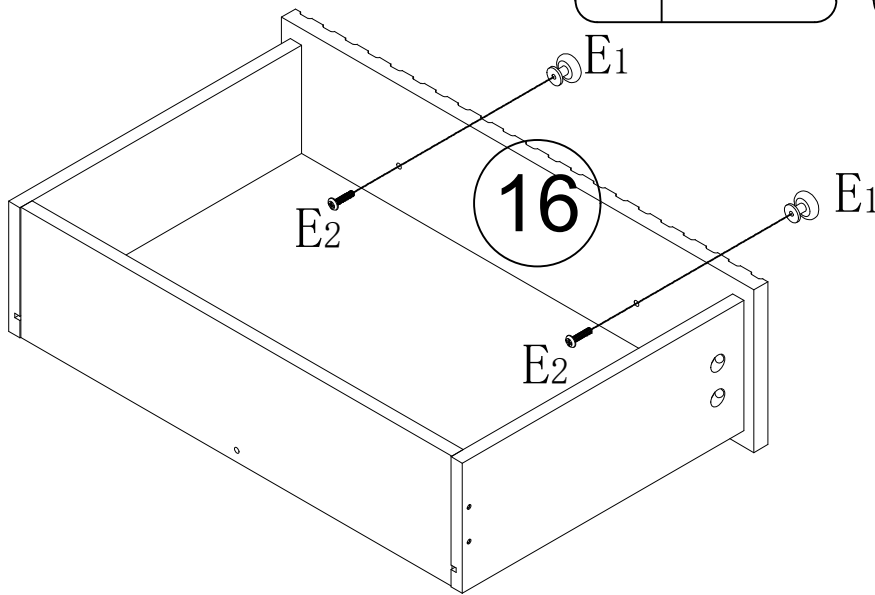
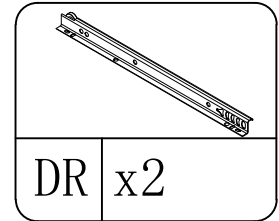
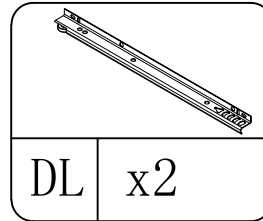
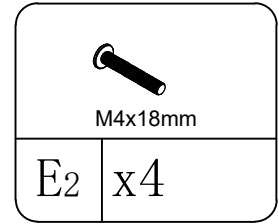
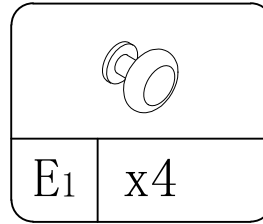
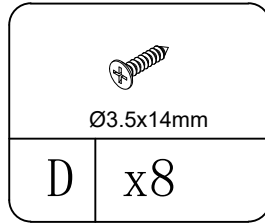
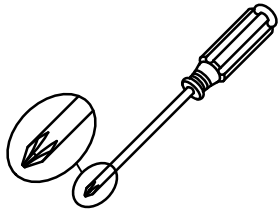

X2

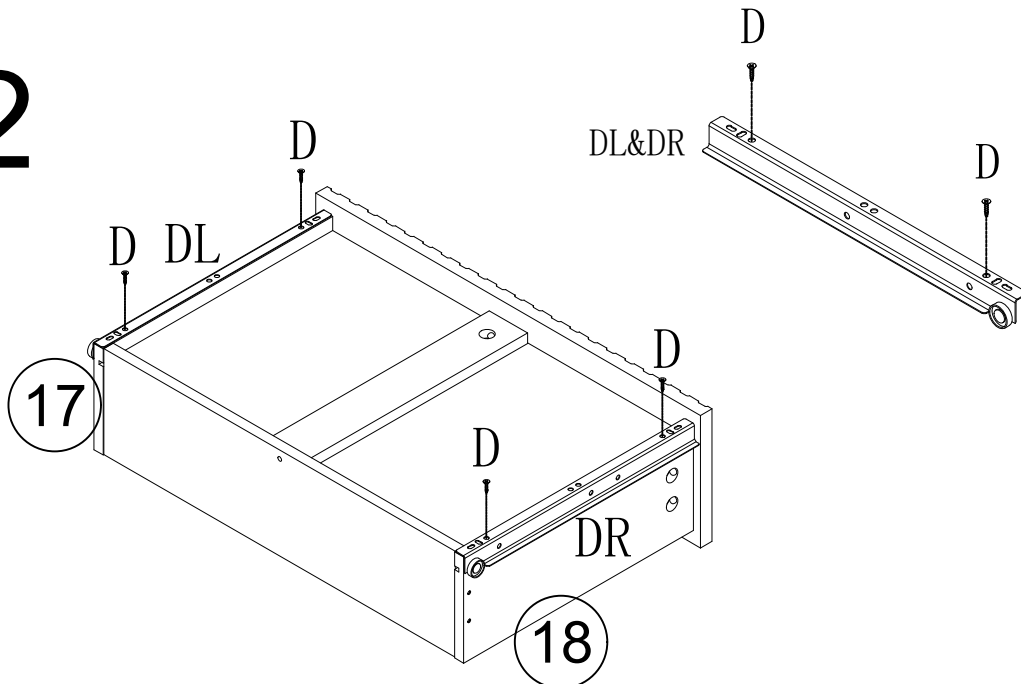

STEP15 Please tighten the screws after completing all installation.

Por favor, apriete los tornillos después de instalar todo.

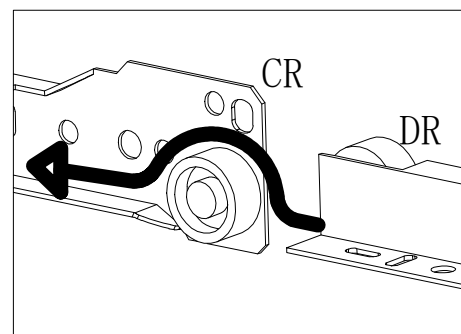
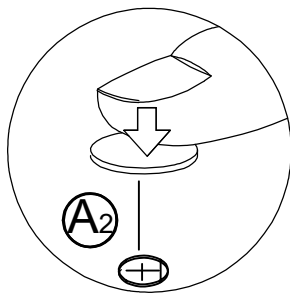
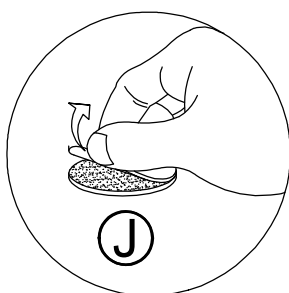
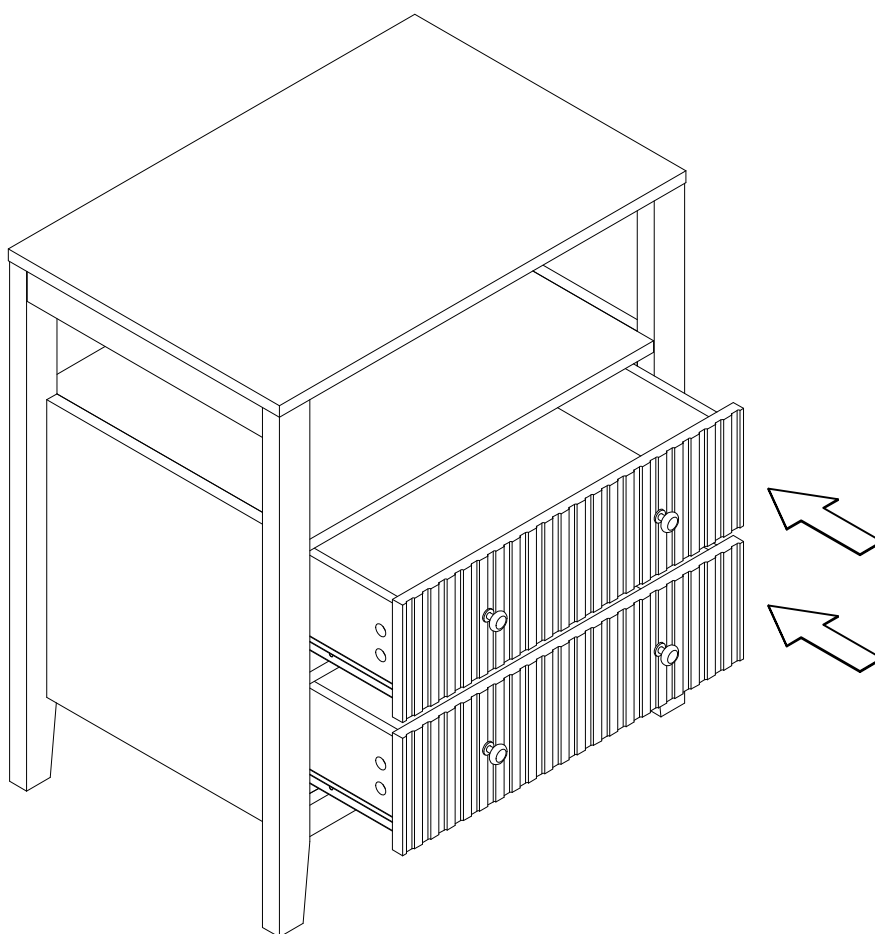
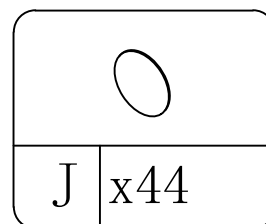

STEP16

Please tighten the screws after completing all installation.

Por favor, apriete los tornillos después de instalar todo.

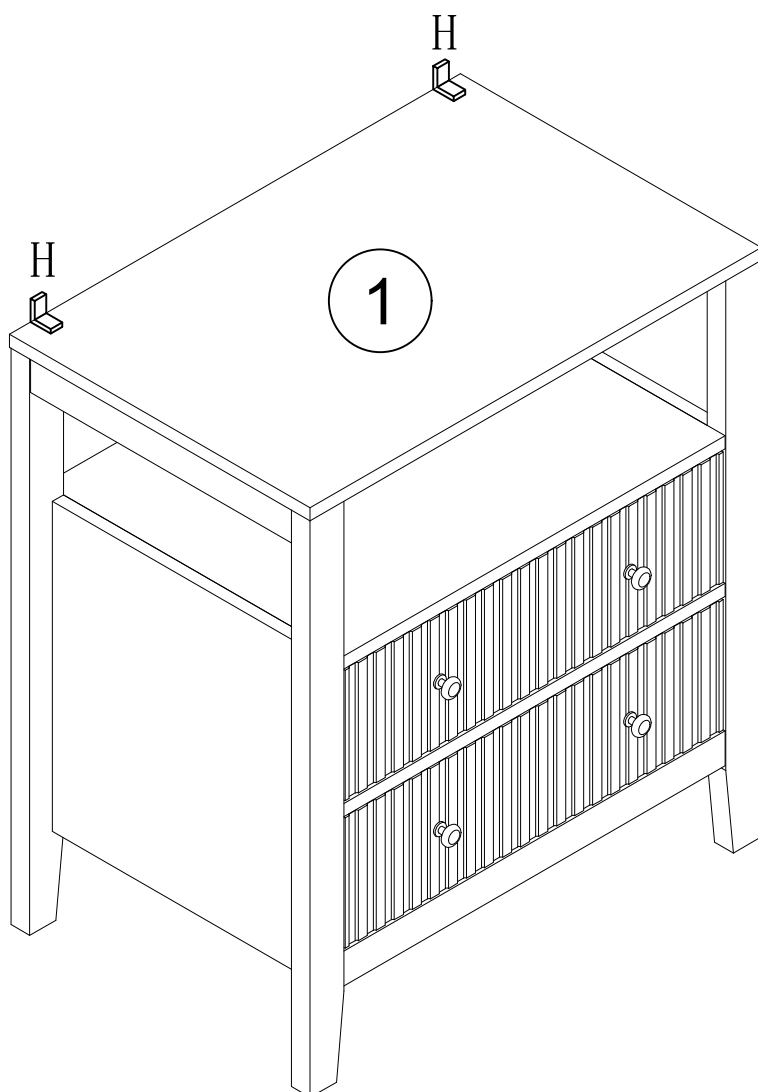
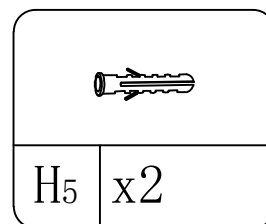
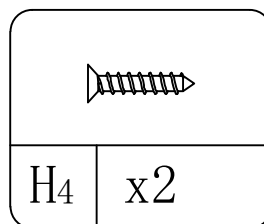
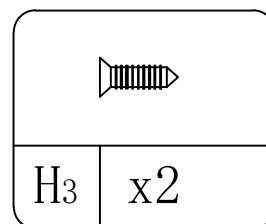
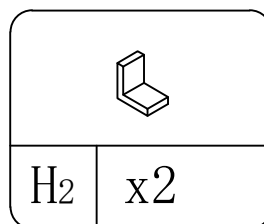
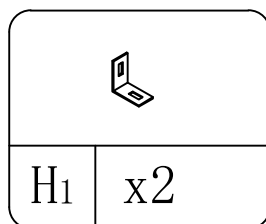

-
-
-
-



MAINTENANCE AND CARE

Prevent Moisture Damage:

Safeguard your laminate furniture by keeping it in a dry environment. Store the furniture away from damp areas and water sources.

Sunlight Shielding:

Shield your laminate furniture from direct sunlight to prevent color fading and surface deterioration. Consider using curtains or blinds for protection, especially if direct sunlight exposure is unavoidable.

Regular Care:

Maintain your laminate furniture's appearance by gently wiping surfaces with a damp cloth. Avoid using overly wet cloths or abrasive cleaning tools.

Avoid Scratches:

Protect the furniture surface from scratches by refraining from placing sharp or hard objects on it. When moving the furniture, be cautious not to scrape the legs against the floor.

Proper Weight Distribution:

Prevent structural damage by placing heavy objects on stable support surfaces rather than directly on the laminate furniture's surface. This simple step can prolong the life of your furniture.

Evite daños por humedad:

Proteja sus muebles laminados manteniéndolos en un ambiente seco. Guarde los muebles lejos de zonas húmedas y fuentes de agua.

Protéjalos de la luz solar:

Proteja sus muebles laminados de la luz solar directa para evitar la pérdida de color y el deterioro de la superficie. Considere el uso de cortinas o persianas como protección, especialmente si la exposición directa a la luz solar es inevitable.

Cuidado regular:

Mantenga el aspecto de sus muebles laminados limpiando suavemente las superficies con un paño húmedo. Evite utilizar paños demasiado húmedos o herramientas de limpieza abrasivas.

Evite los arañazos:

Proteja la superficie del mueble de arañazos evitando colocar objetos afilados o duros sobre ella. Al mover el mueble, tenga cuidado de no raspar las patas contra el suelo.

Distribución adecuada del peso:

Evite daños estructurales colocando objetos pesados sobre superficies de apoyo estables en lugar de directamente sobre la superficie del mueble laminado. Este sencillo paso puede prolongar la vida de sus muebles.



WARRANTY INFORMATION

Warranty Coverage: Our warranty provides protection against manufacturing defects in materials and workmanship for a specified period from the date of purchase, as outlined in the accompanying warranty documentation.

Exclusions: The warranty does not cover damages resulting from misuse, negligence, accidents, normal wear and tear, unauthorized repairs or modifications, improper assembly, or failure to adhere to the care and maintenance guidelines provided.

WARRANTY CLAIM PROCESS

To initiate a return, please follow these steps:

1. Log into your account and go to the "Your Orders" section.
2. Locate the order containing the item you wish to return.
3. Contact our customer service for assistance in obtaining a prepaid return label.
4. Once you receive the return label, securely affix it to the package.
5. You can then choose to drop off the package at a designated carrier location or arrange for a pickup.
6. After we receive and inspect the returned product, we will initiate the refund process.
7. The refund will be credited back to the original payment method used during the purchase.
8. Typically, refunds are processed within 3-5 business days.

Cobertura de la garantía: Nuestra garantía proporciona protección contra defectos de fabricación en materiales y mano de obra durante un período determinado a partir de la fecha de compra, como se indica en la documentación de garantía adjunta.

Exclusiones: La garantía no cubre los daños resultantes de uso indebido, negligencia, accidentes, desgaste normal, reparaciones o modificaciones no autorizadas, montaje incorrecto o incumplimiento de las directrices de cuidado y mantenimiento proporcionadas. Las directrices de cuidado y mantenimiento proporcionadas.

PROCESO DE RECLAMACIÓN DE LA GARANTÍA

Para iniciar una devolución, siga estos pasos:

1. Accede a tu cuenta de y ve a la sección "Tus pedidos".
2. Localiza el pedido que contiene el artículo que deseas devolver.
3. Ponte en contacto con nuestro servicio de atención al cliente para que te ayuden a obtener una etiqueta de devolución prepagada.
4. Después de que recibamos e inspeccionemos el producto devuelto, iniciaremos el proceso de reembolso.
5. El reembolso se abonará de nuevo al método de pago original utilizado durante la compra.
6. Normalmente, los reembolsos se procesan en un plazo de 3 a 5 días laborables.
7. Una vez que reciba la etiqueta de devolución, fíjela firmemente al paquete.
8. A continuación, puede optar por depositar el paquete en el lugar designado por el transportista o solicitar que lo recojan.