

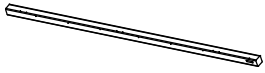









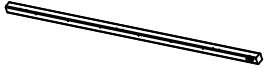

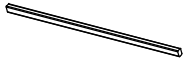
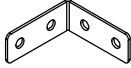

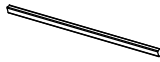
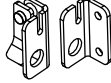

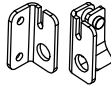

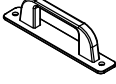

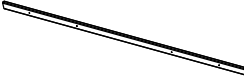

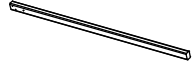





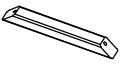
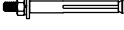

A1		4	P		18
A2		2	Q1		10
B1		10	Q2		36
B2		15	S		10
B3		5	T1	 	1
C		10	T2	 	1
D1		2	U	 	2
D2		2	V		3
E1		2	H1	 M4x15	10
E2		1	H2	 M4x25	206
E3		2	H3	 M4x35	60
E4		1	H4	 M4x45	175
F		7	H5	 M4x60	7
G1		12	H6	 M6x50	9
G2		2	H7	 M6-10	1
G3		6	H8		2
J		2			
K		1			

1

C		10	B1		10
B3		5	Q2		30
H2	 M4x25	120			



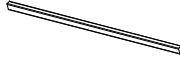
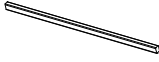
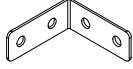
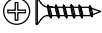
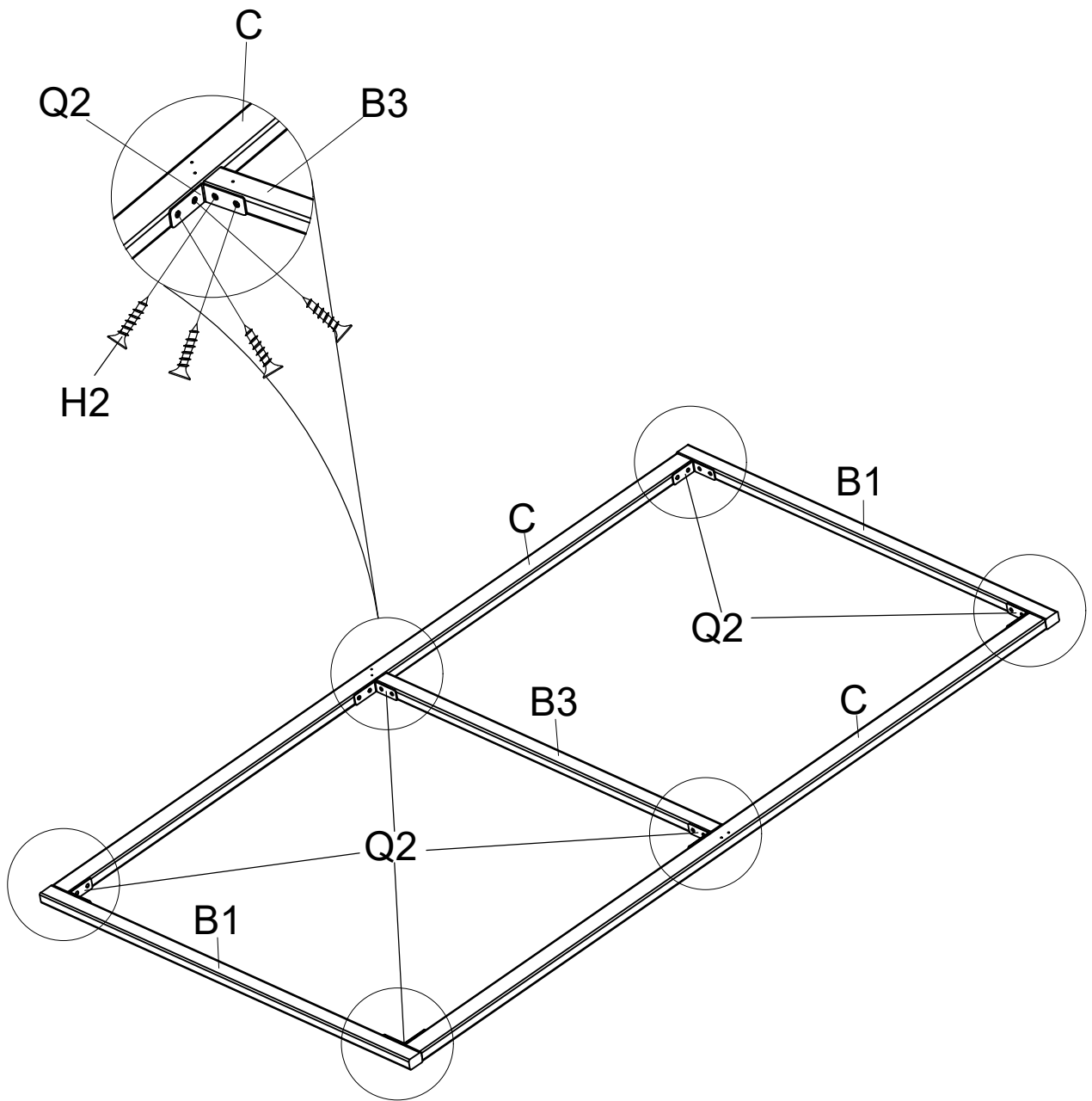

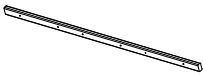
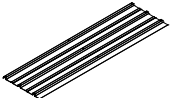
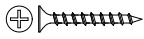
2

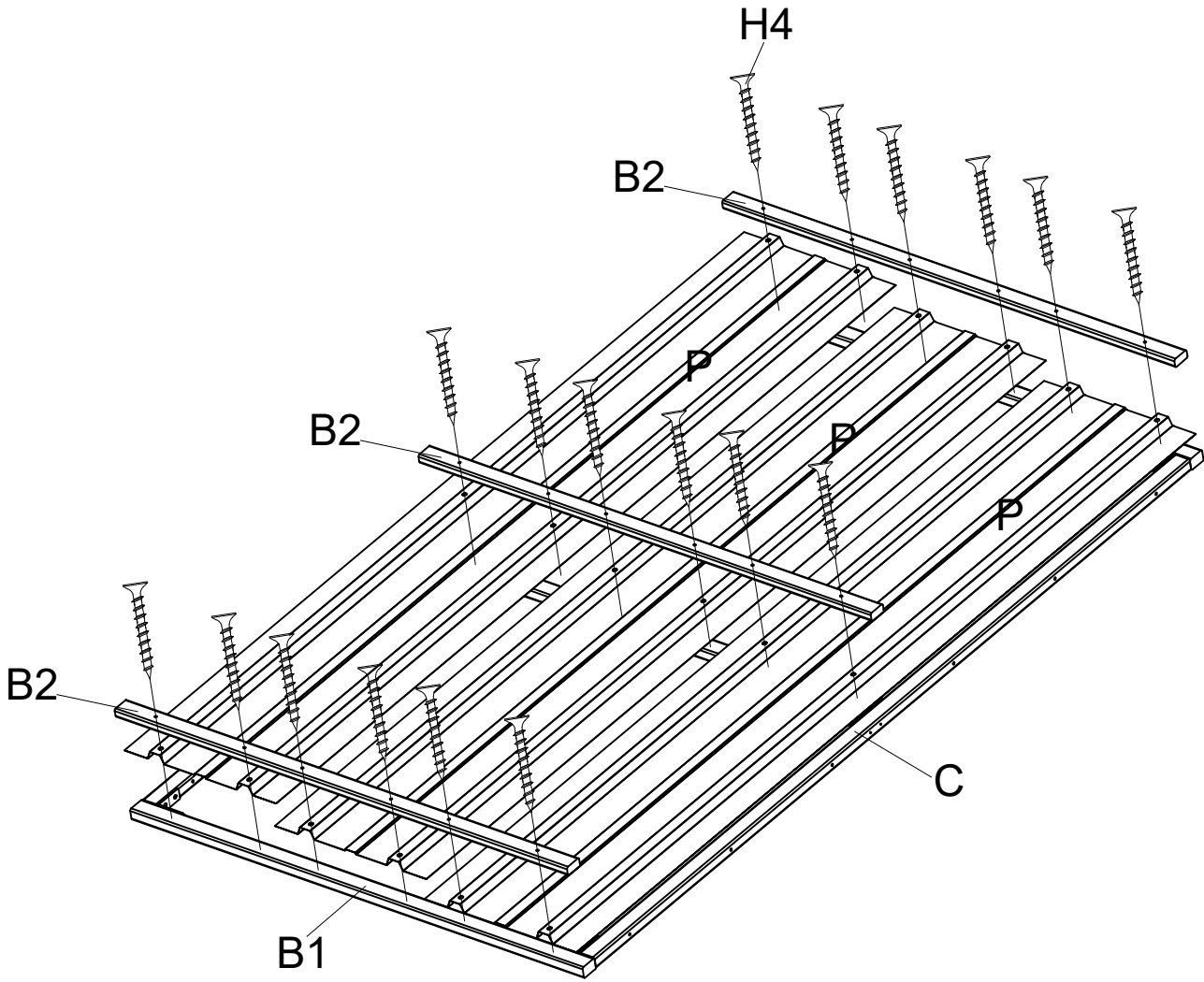
B2		15	P		15
H4	 M4x45	90			

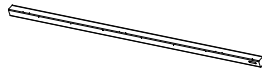

3

A1		2	A2		1
F		2	H2	 M4x25	4
H4	 M4x45	12			

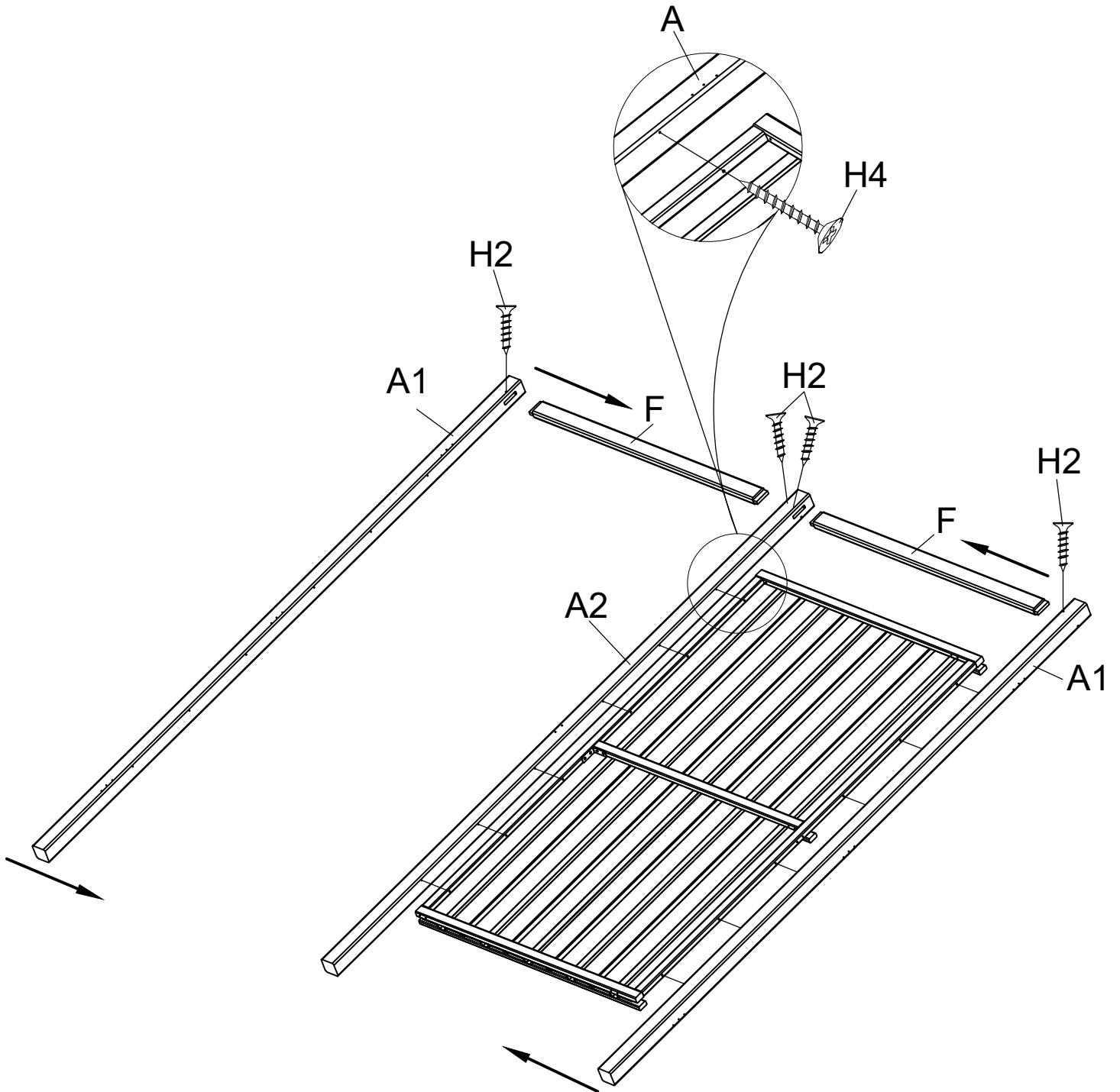

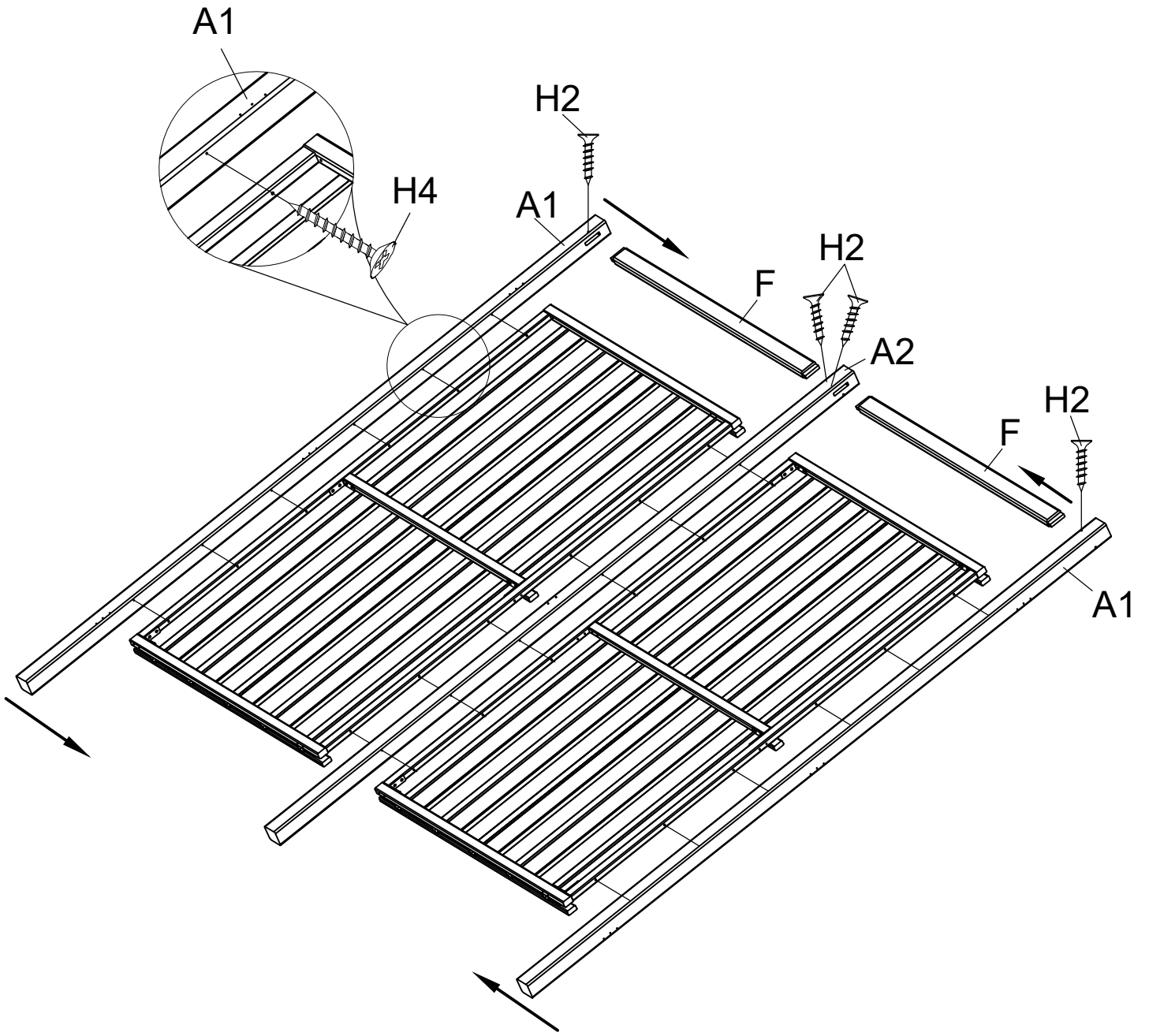

4

A1		2	A2		1
F		2	H2	 M4x25	4
H4	 M4x45	24			

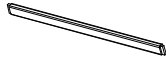

5

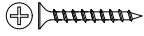
F		3	H2	 M4x25	6
H4	 M4x45	24			

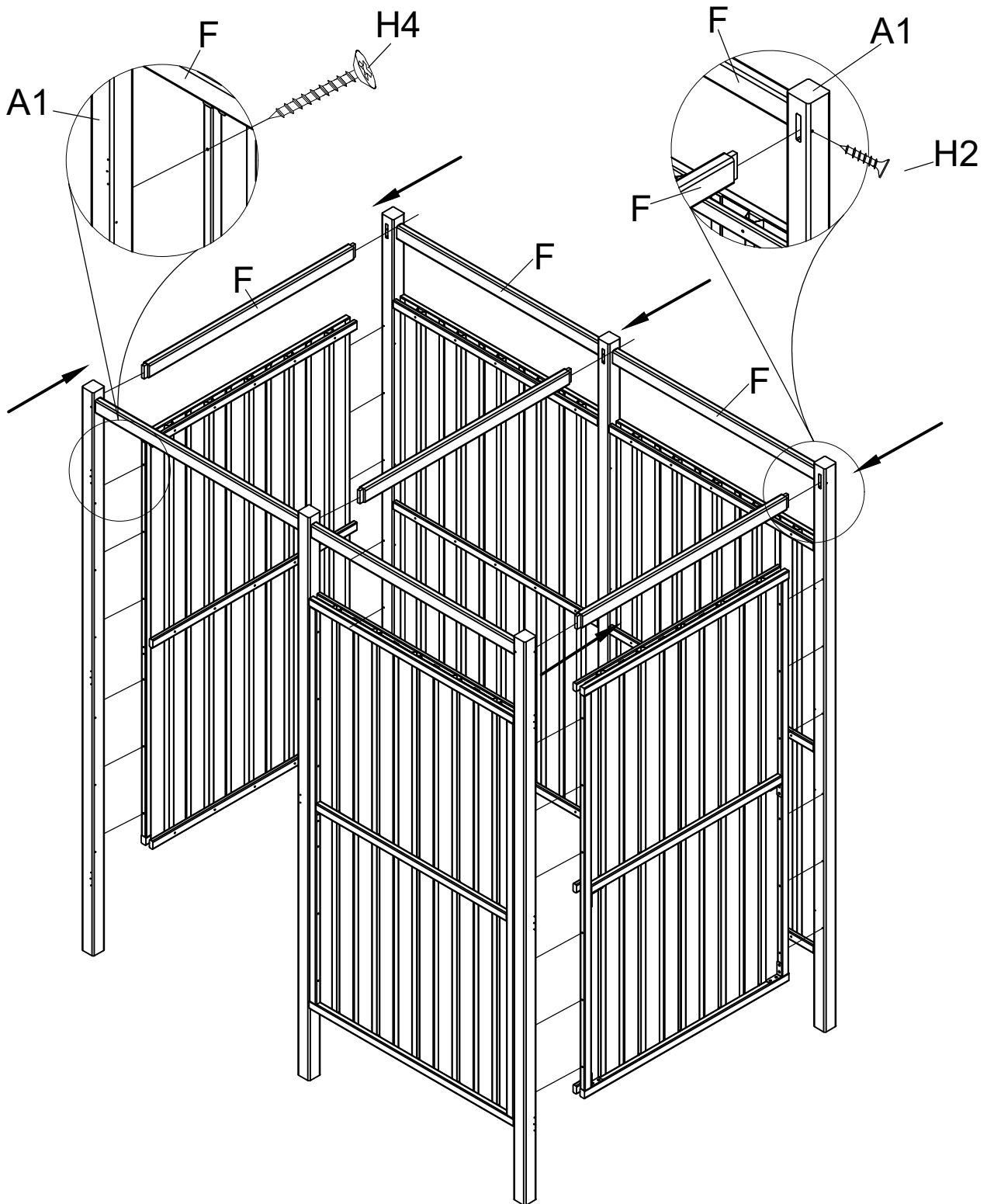

6

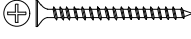
G3		6	H6	 M4x60	6
----	-----------------------------------------------------------------------------------	---	----	----------------------------------------------------------------------------------------------	---

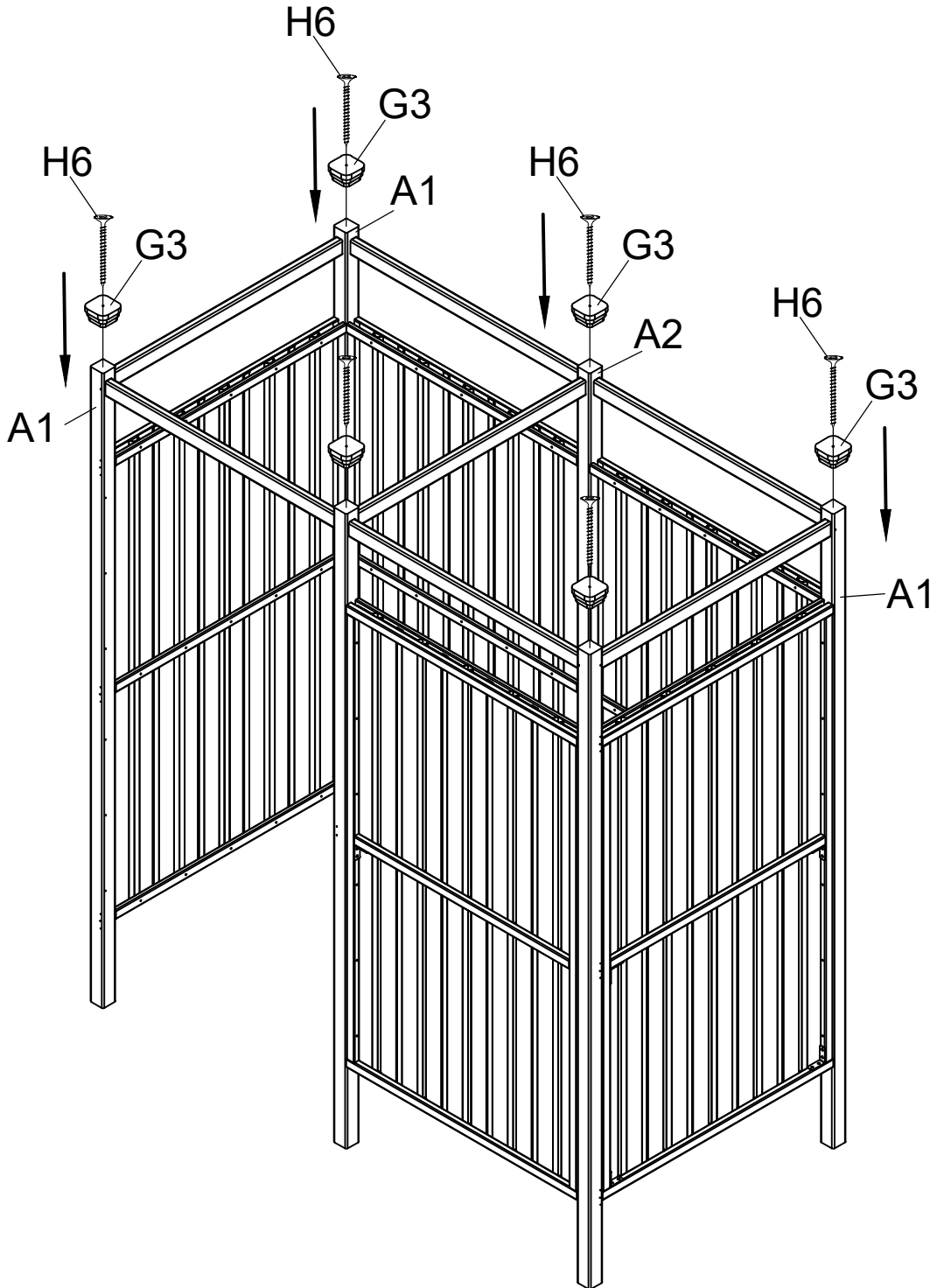

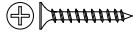

7

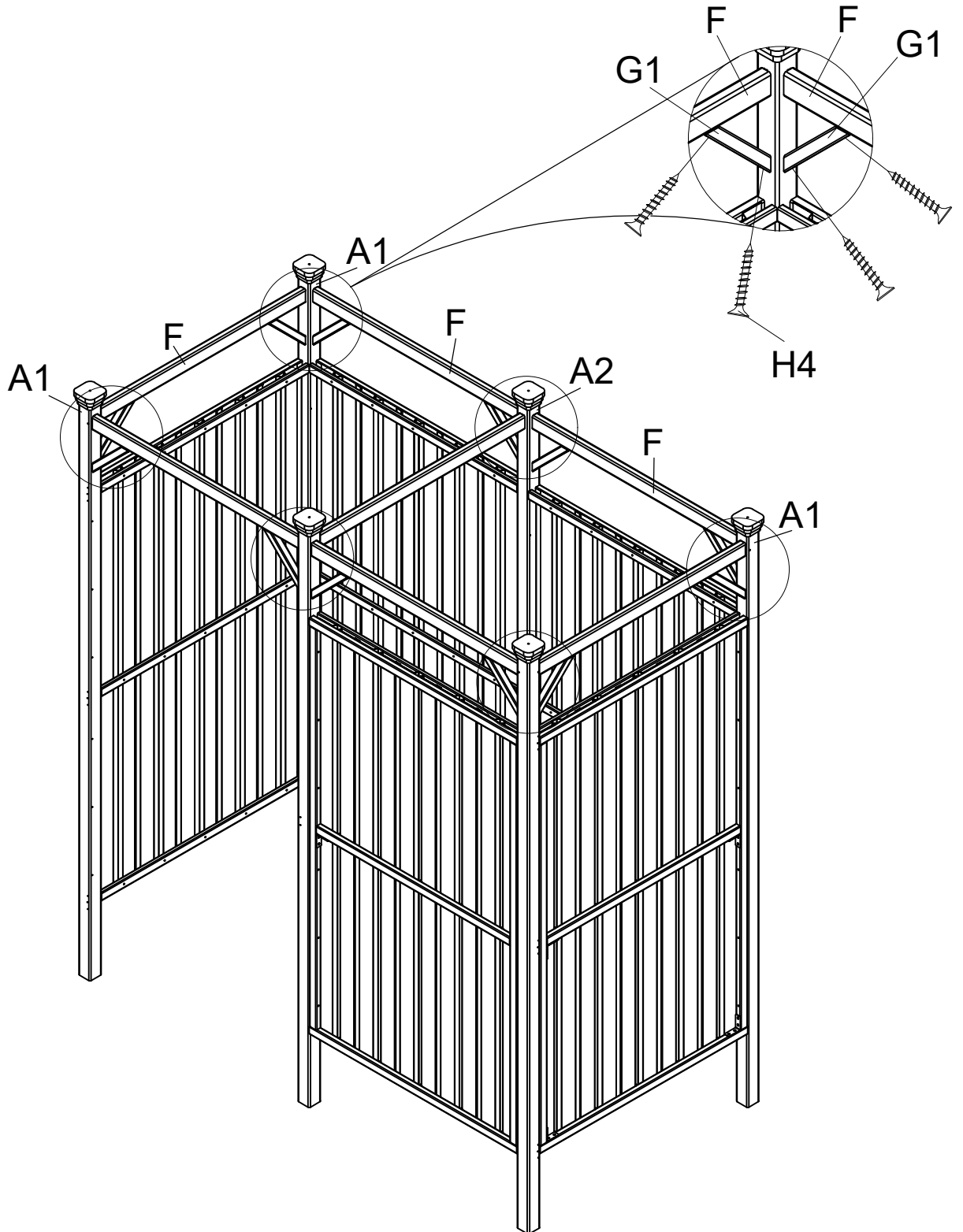
G1		12	H3	 M4x35	24
----	-----------------------------------------------------------------------------------	----	----	----------------------------------------------------------------------------------------------	----

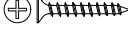

8

Q1		10	G2		2
H1	 M4x15	10	H3	 M4x35	4

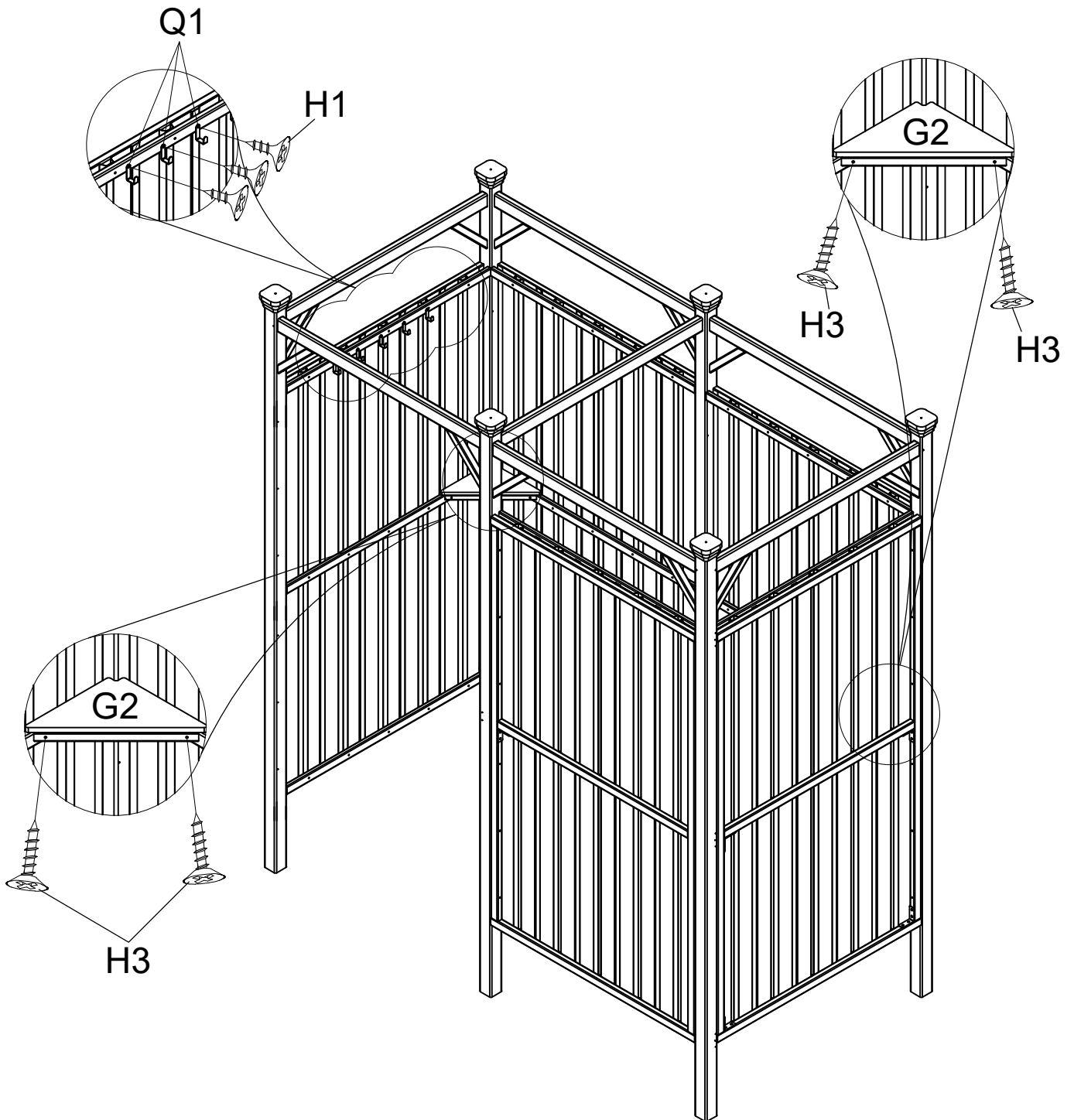

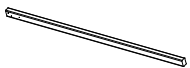
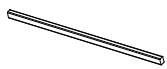
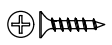
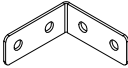

9

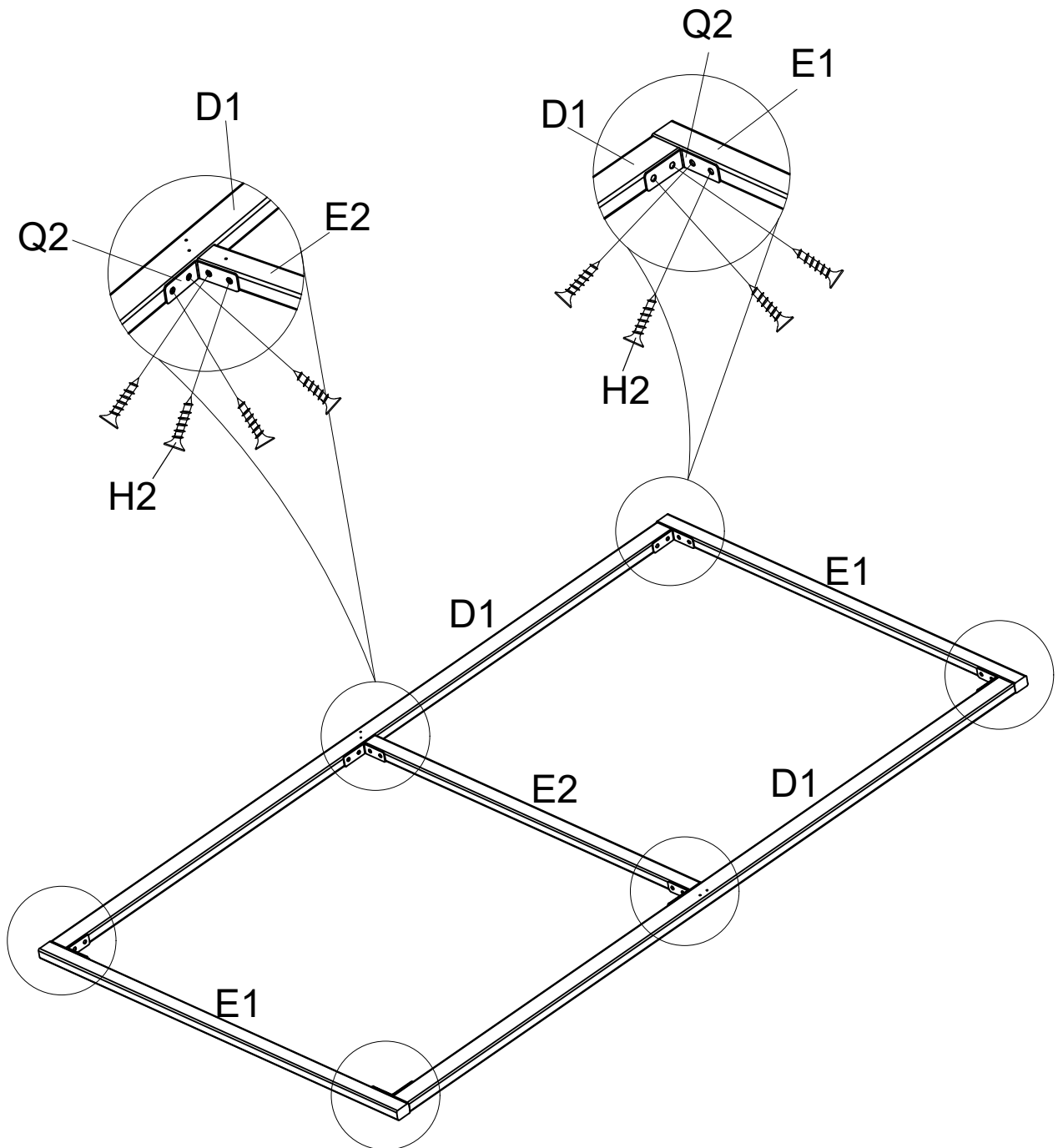
D1		2	E1		2
E2		1	H2	 M4x25	24
Q2		6			



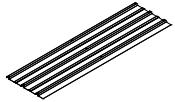
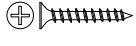
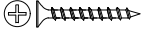

10

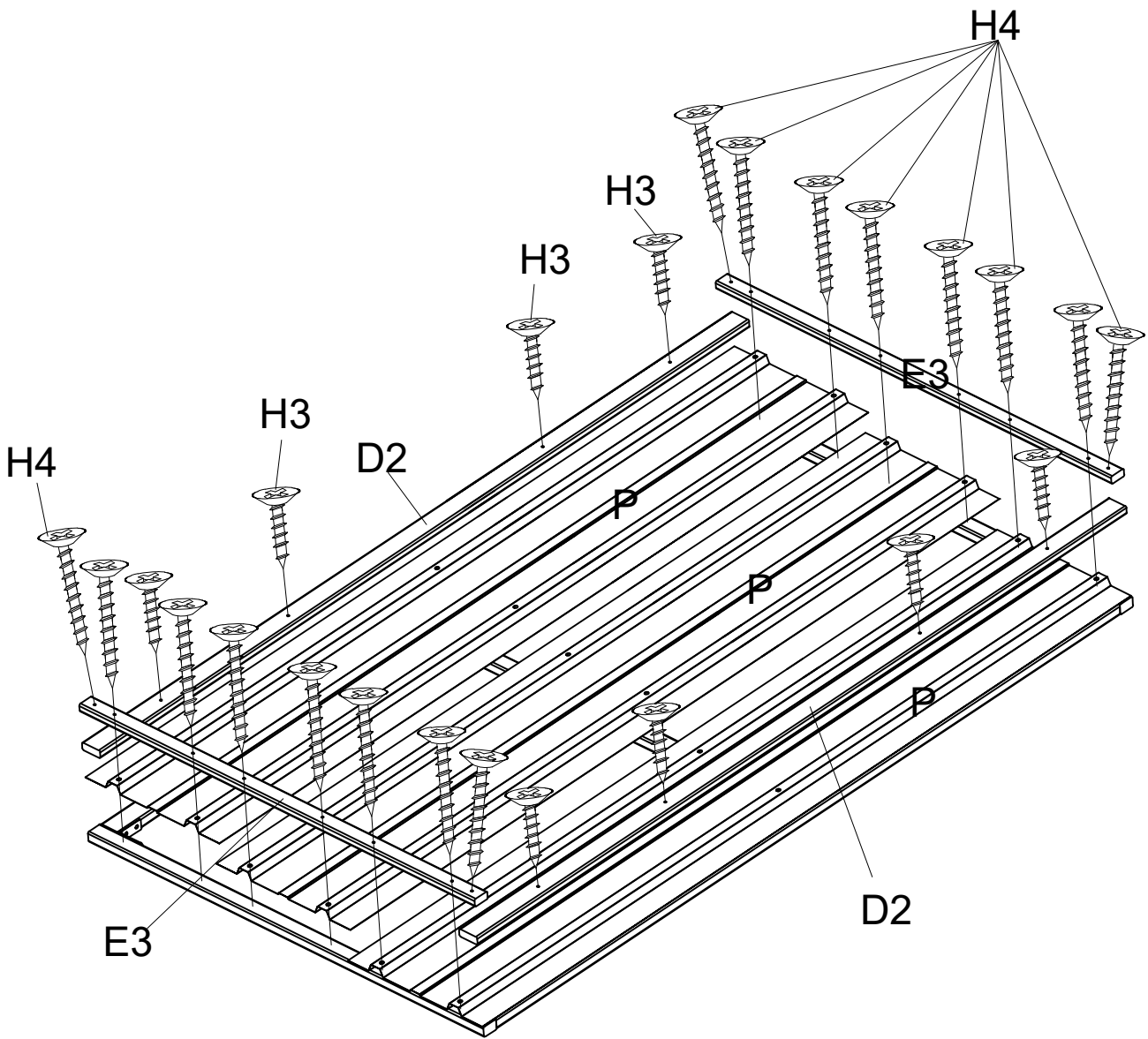
D2		2	E3		2
P		3	H3	 M4x35	8
H4	 M4x45	16			

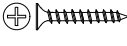

11

E4		1	J		2
H3	 M4x35	14			

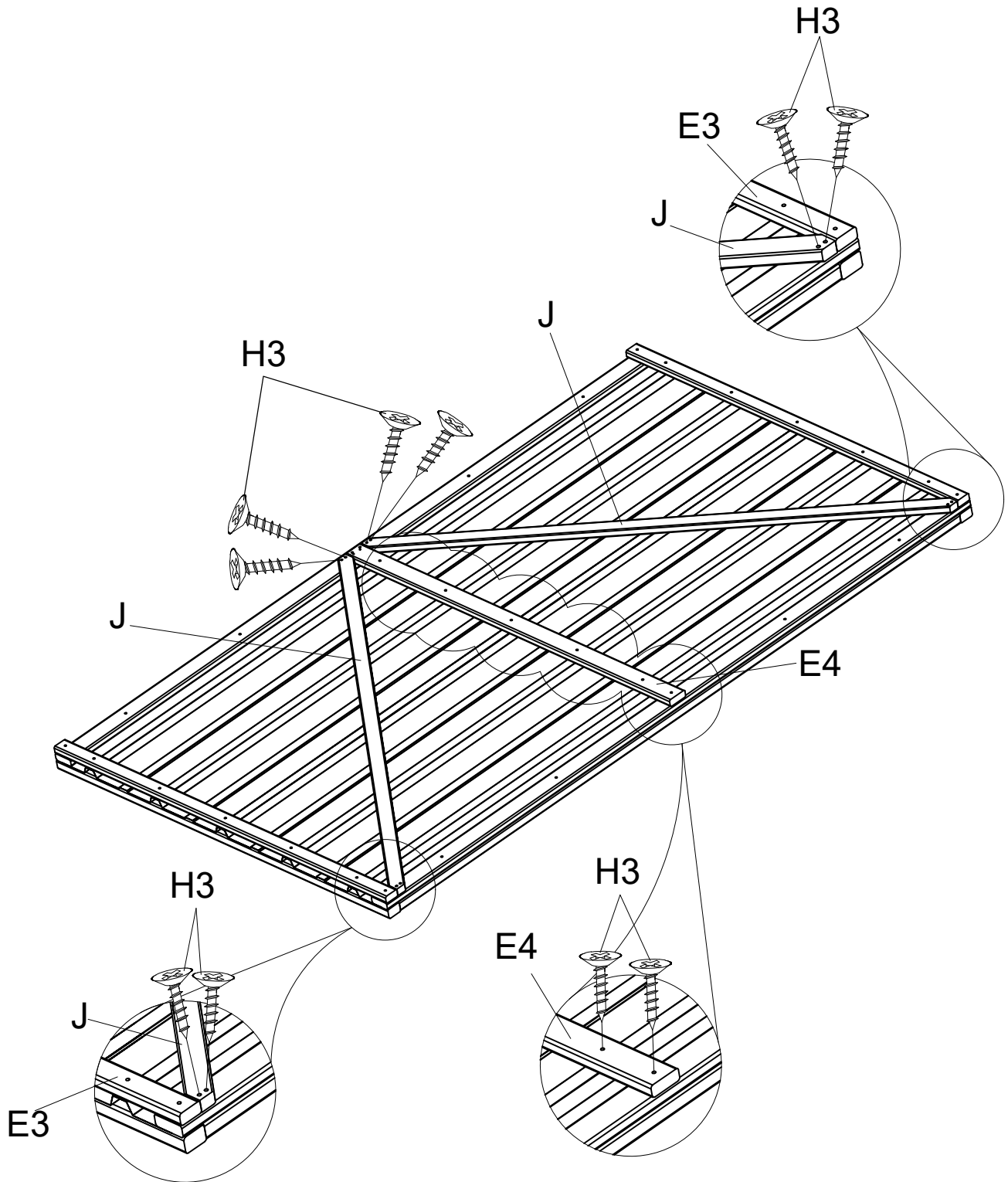

12

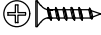
V		3	H2	 M4x25	9
---	-----------------------------------------------------------------------------------	---	----	----------------------------------------------------------------------------------------------	---

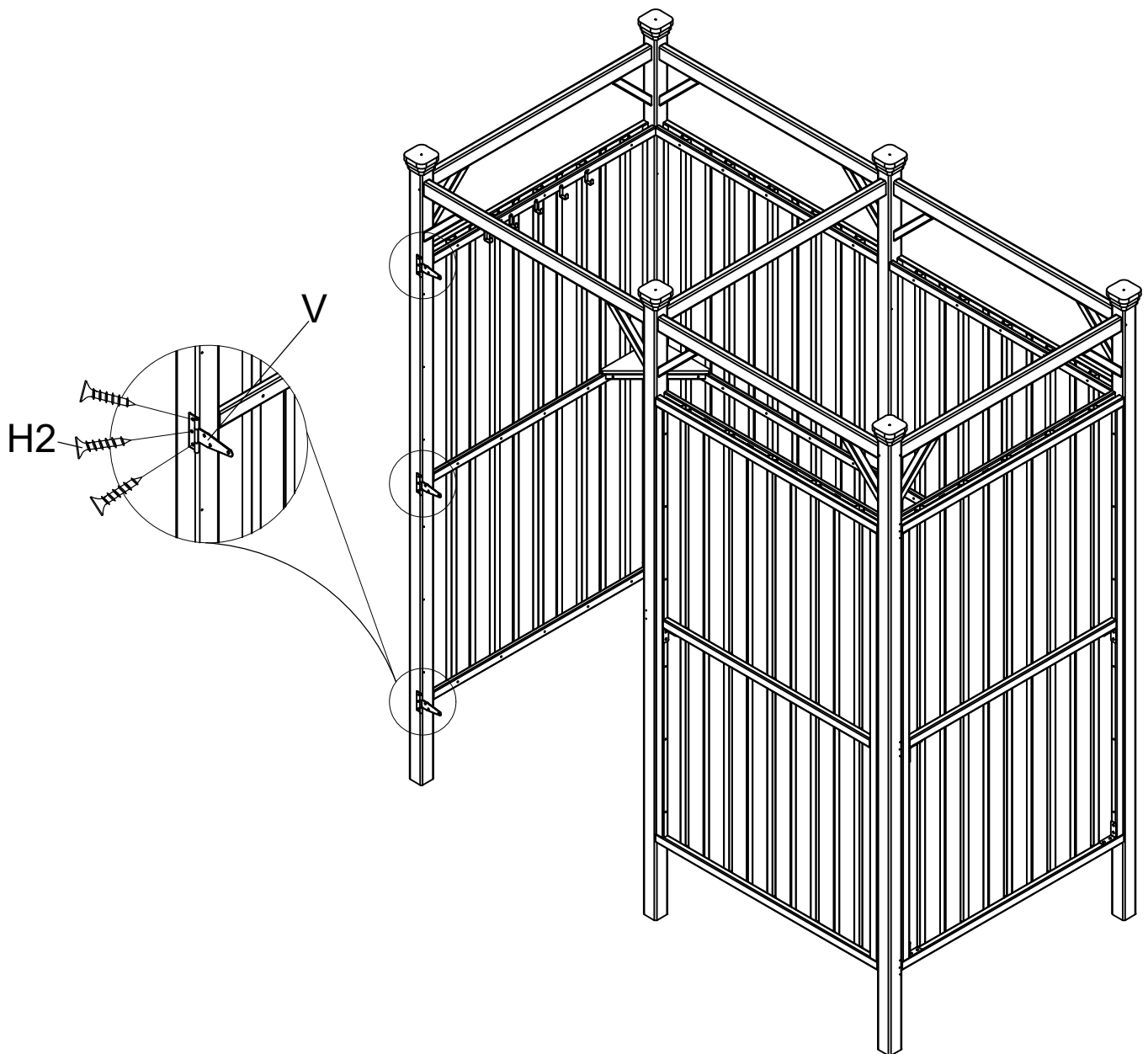

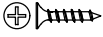
H2	 M4x25	9
----	--------------------------------------------------------------------------------------------	---

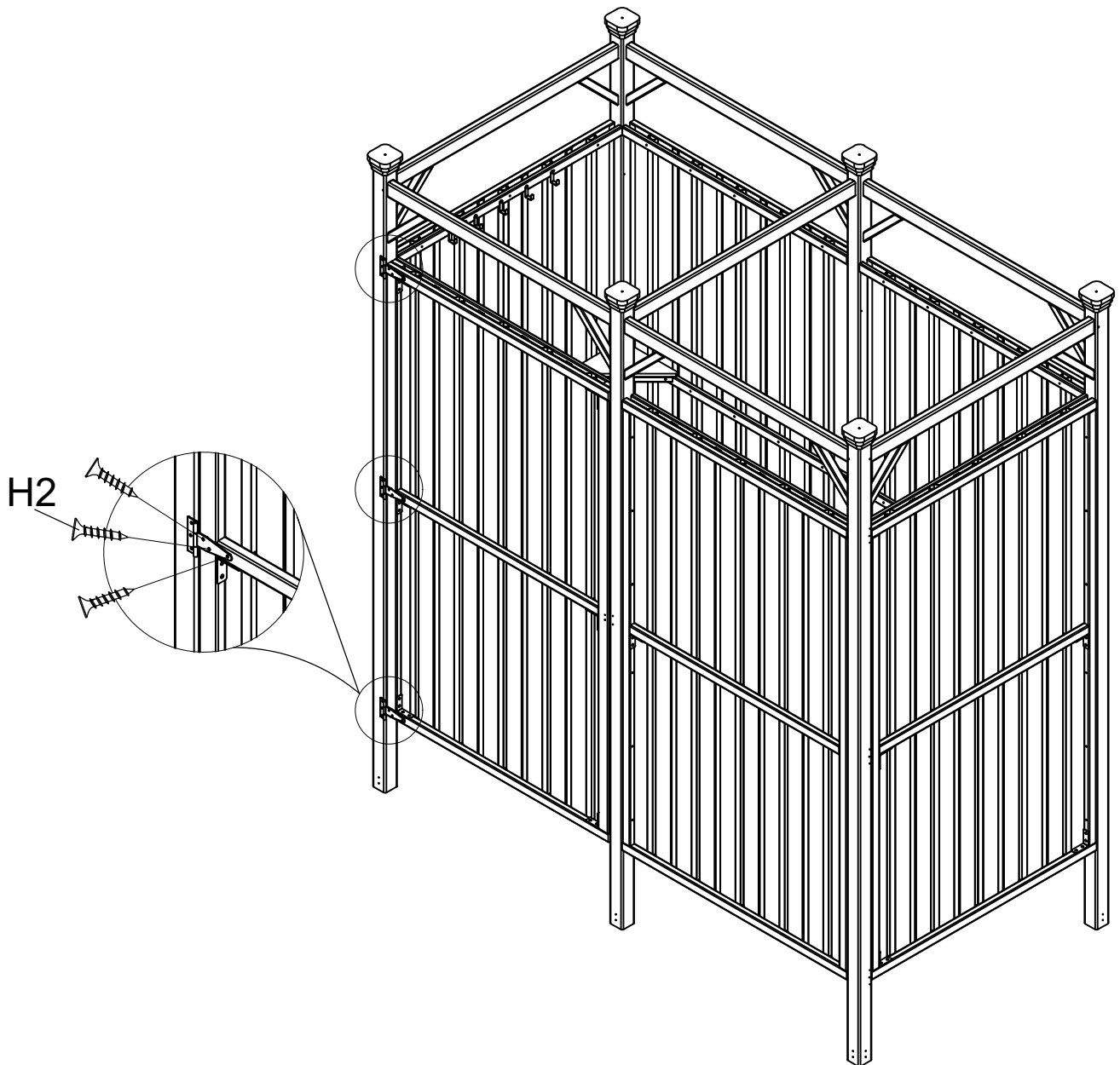

14

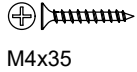

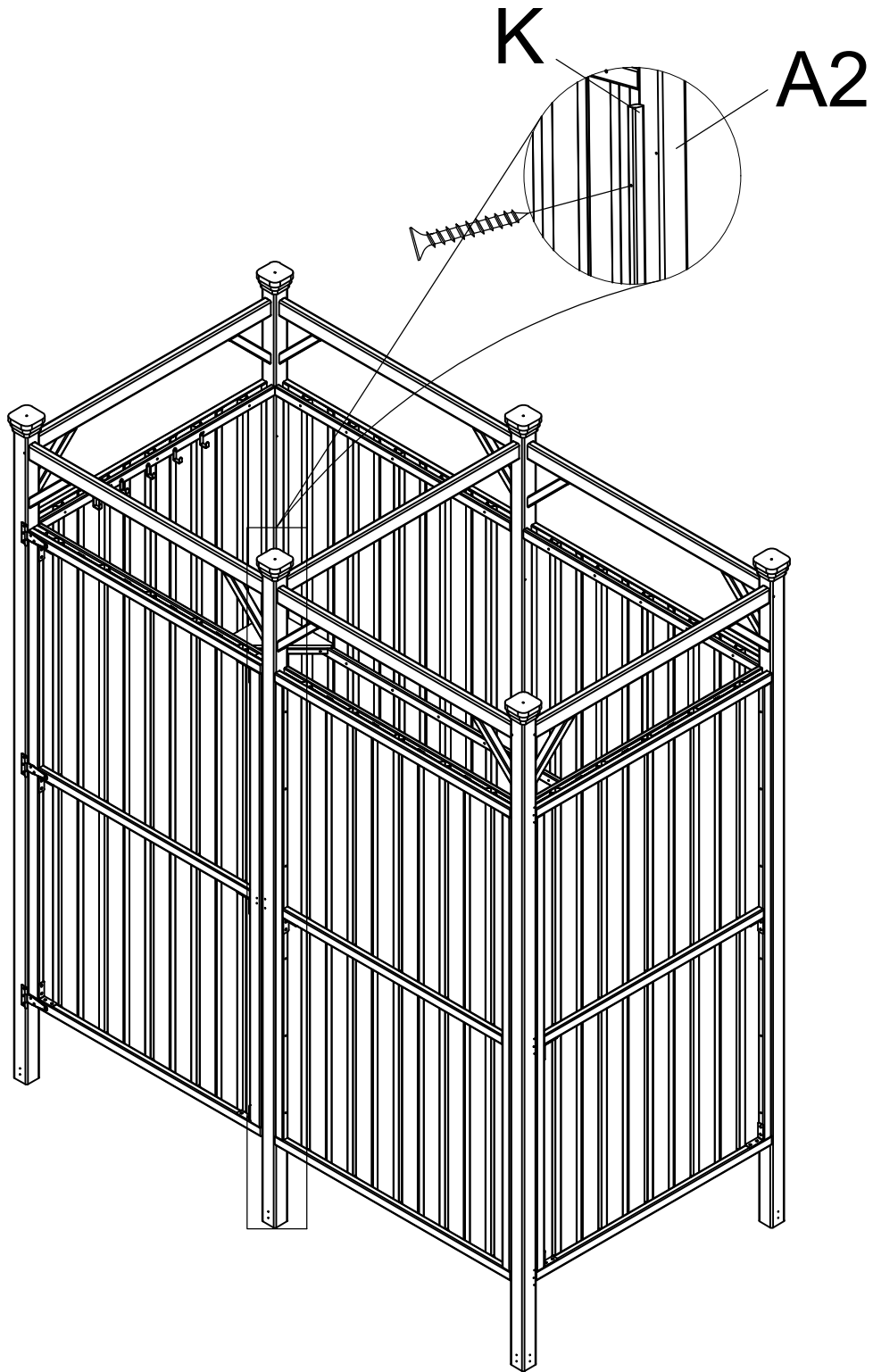
K		1	H3	 M4x35	6
---	-----------------------------------------------------------------------------------	---	----	----------------------------------------------------------------------------------------------	---

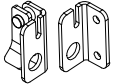
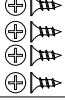
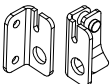
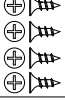

15

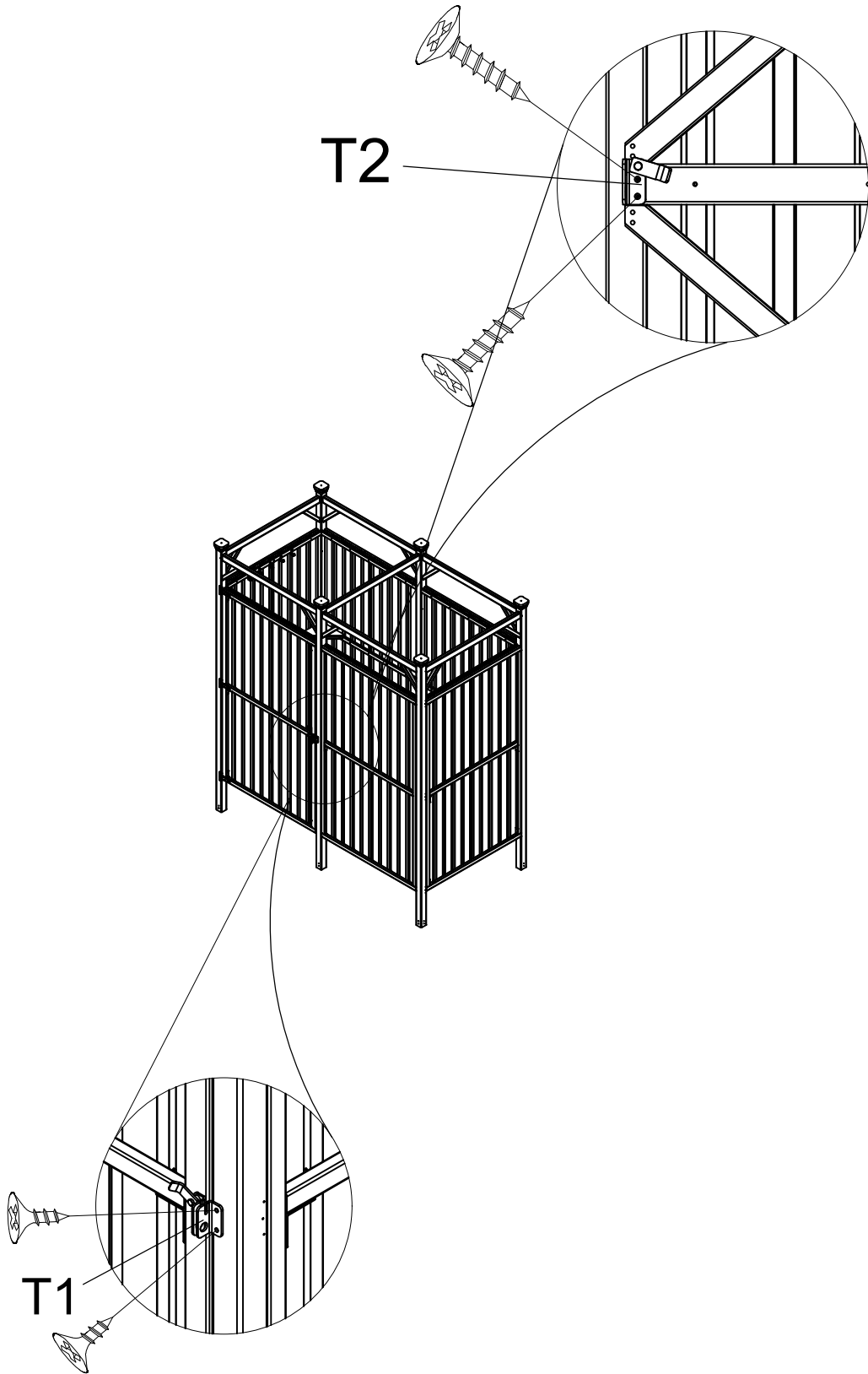
T1			1	T2			1
----	-----------------------------------------------------------------------------------	-----------------------------------------------------------------------------------	---	----	-------------------------------------------------------------------------------------	-------------------------------------------------------------------------------------	---

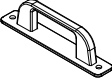

U			2
---	-----------------------------------------------------------------------------------	-----------------------------------------------------------------------------------	---

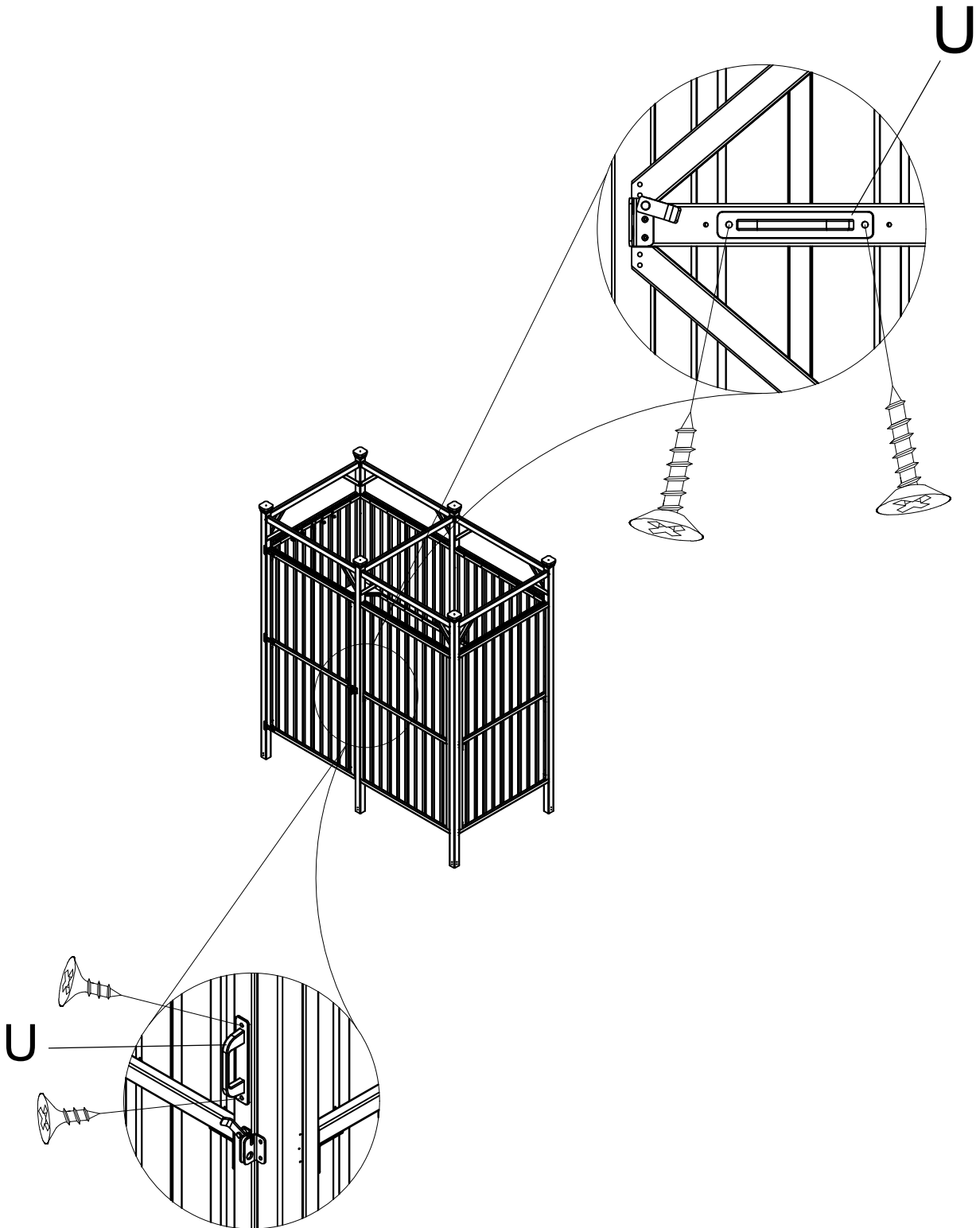

17

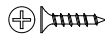
S		10	H2	 M4x25	16
---	-----------------------------------------------------------------------------------	----	----	----------------------------------------------------------------------------------------------	----

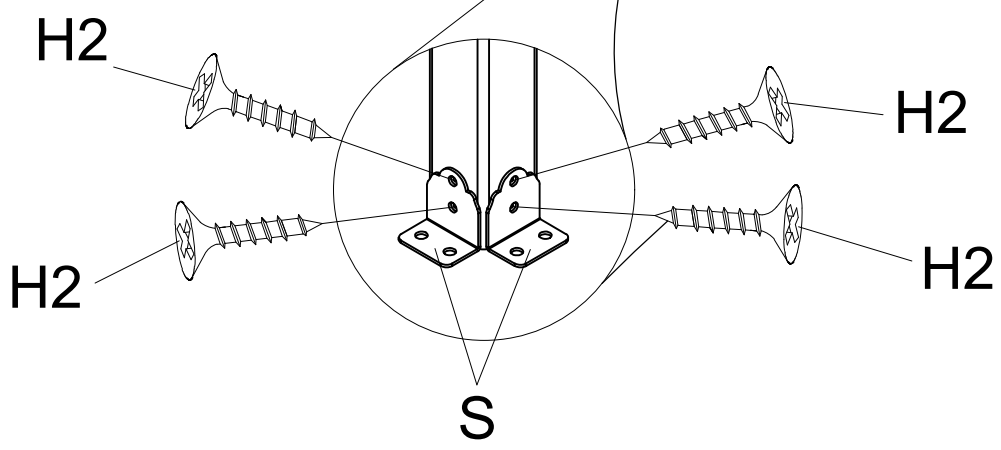
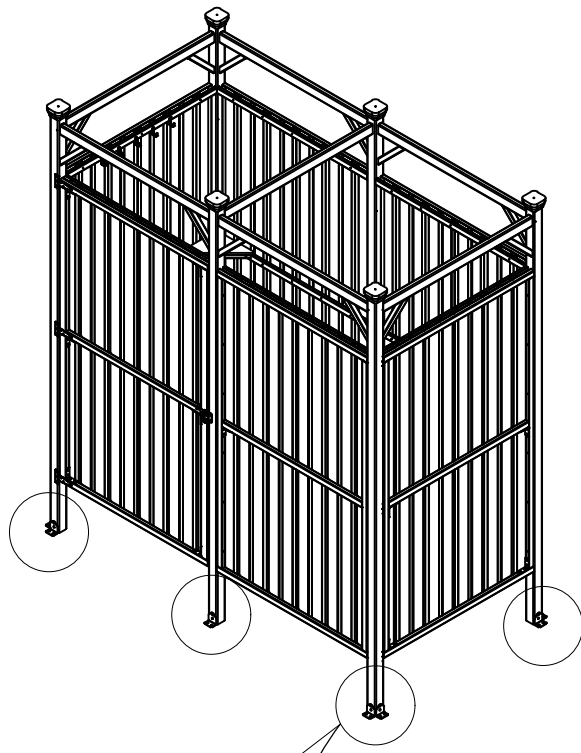

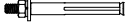
H7	 M8x50	12
----	--------------------------------------------------------------------------------------------	----

