

# ASSEMBLY INSTRUCTION

## Full Size Daybed with Trundle MF300702

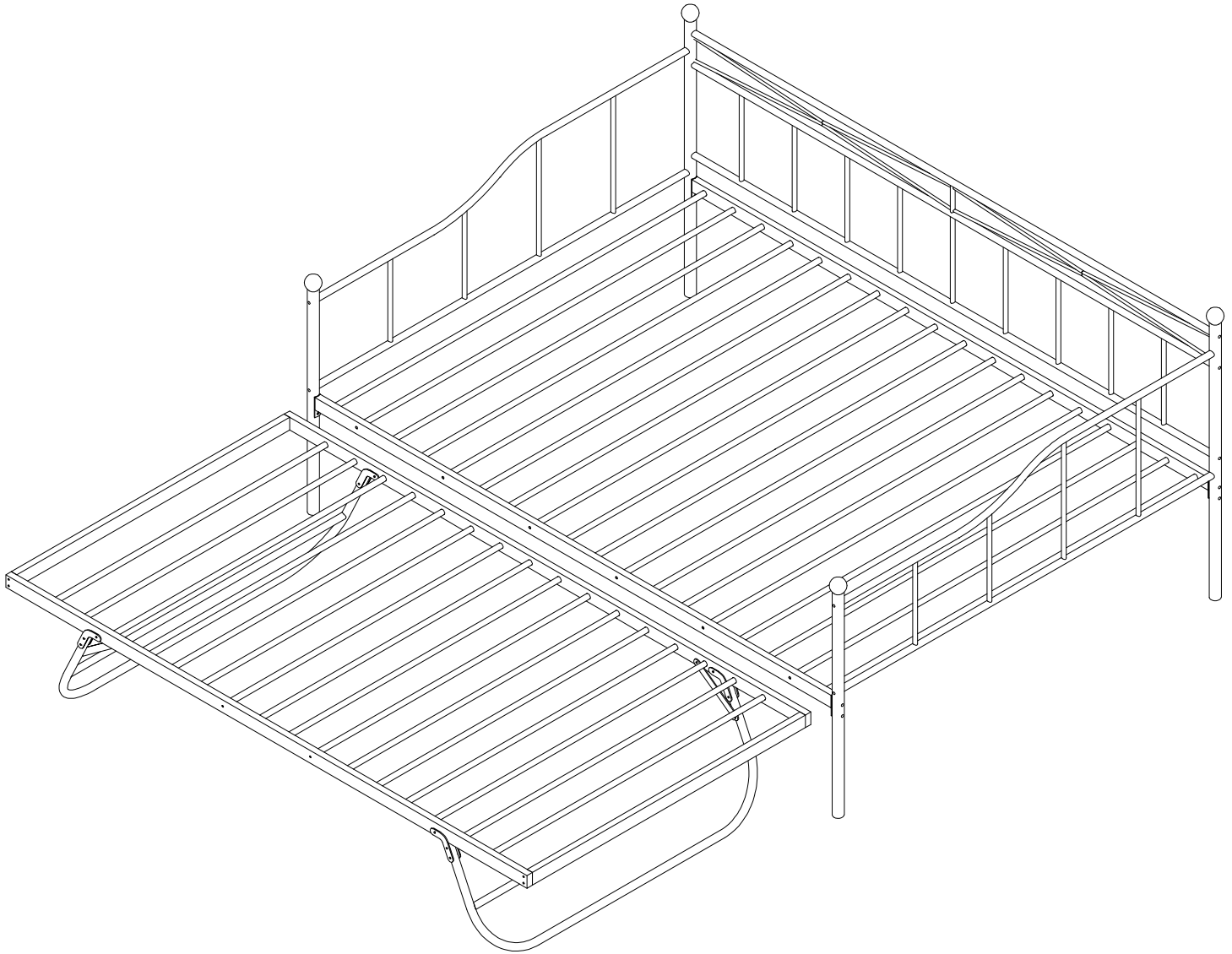

	 30MIN	
STOOLS	INSTALATION TIME	TWO PEOPLE

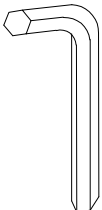
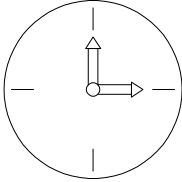
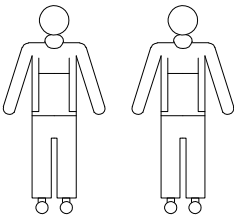

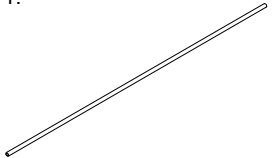
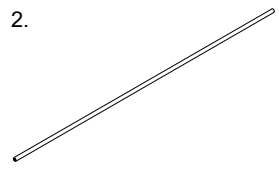
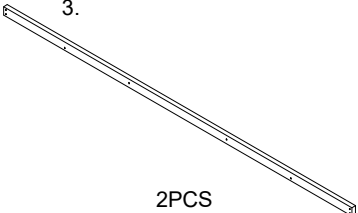
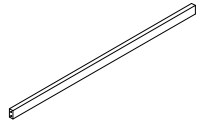

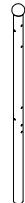
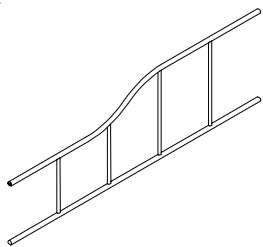
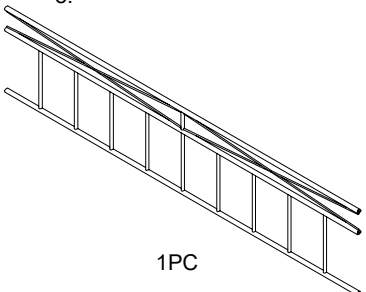
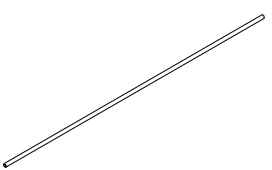
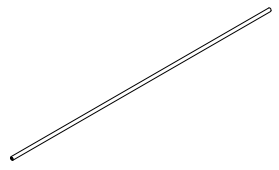
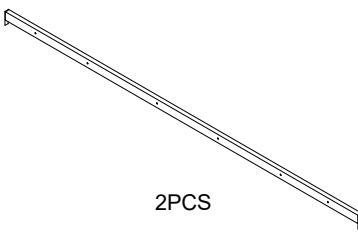
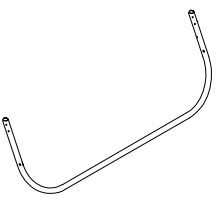
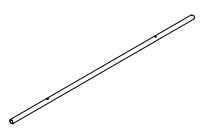
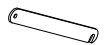
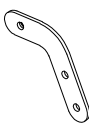

## PART LIST 1

<p>1.</p>  <p>14PCS</p>	<p>2.</p>  <p>2PCS</p>	<p>3.</p>  <p>2PCS</p>	<p>4.</p>  <p>2PCS</p>
---	---	--	---

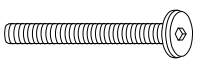
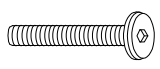
## PART LIST 2 Hardware in this SKU

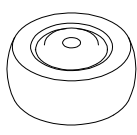
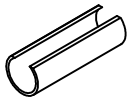
<p>5.</p>  <p>2PCS</p>	<p>6.</p>  <p>2PCS</p>	<p>7.</p>  <p>2PCS</p>	<p>8.</p>  <p>1PC</p>
<p>9.</p>  <p>12PCS</p>	<p>10.</p>  <p>6PCS</p>	<p>11.</p>  <p>2PCS</p>	<p>12.</p>  <p>2PCS</p>
<p>13.</p>  <p>2PCS</p>	<p>14.</p>  <p>2PCS</p>	<p>15.</p>  <p>8PCS</p>	

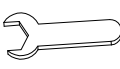
## HARDWARE LIST

<p>A</p>  <p>26PCS M<math>\frac{1}{4}</math>"X45</p>	<p>B</p>  <p>24PCS M<math>\frac{1}{4}</math>"X35</p>	<p>C</p>  <p>20PCS M<math>\frac{1}{4}</math>"X20</p>	<p>D</p>  <p><math>\varnothing</math>6x19x1.5 10PCS</p>	<p>E</p>  <p>4PCS 24X50</p>
<p>F</p>  <p>4PCS <math>\varnothing</math>22X36X36</p>	<p>G</p>  <p>12PCS M<math>\frac{1}{4}</math>"X10x5</p>	<p>H</p>  <p>4PCS <math>\varnothing</math>38x20</p>	<p>i</p>  <p>1PC 10mm</p>	<p>j</p>  <p>1PC M4X23X57</p>

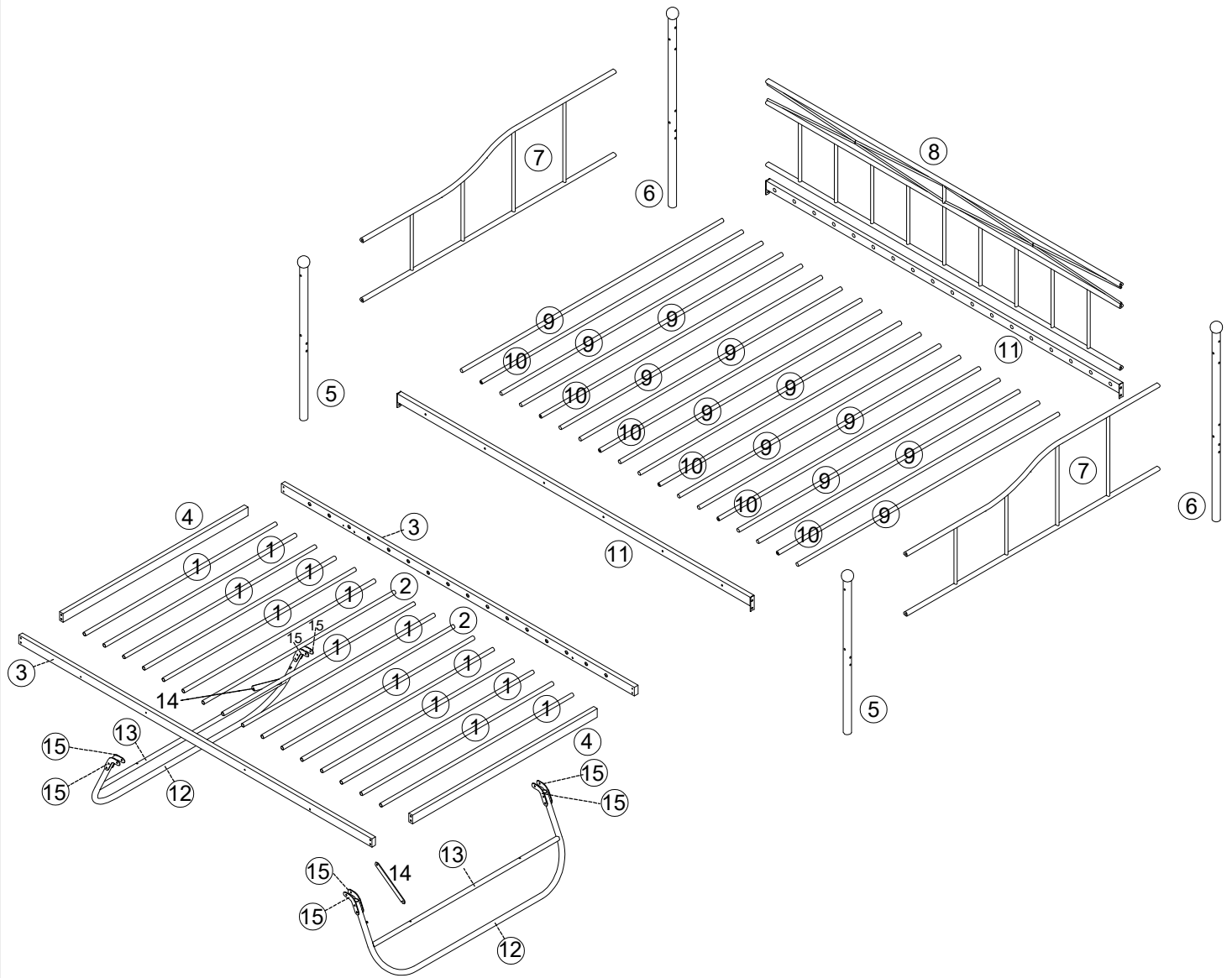

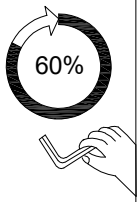
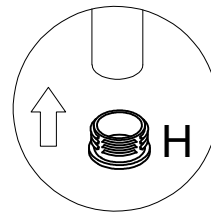
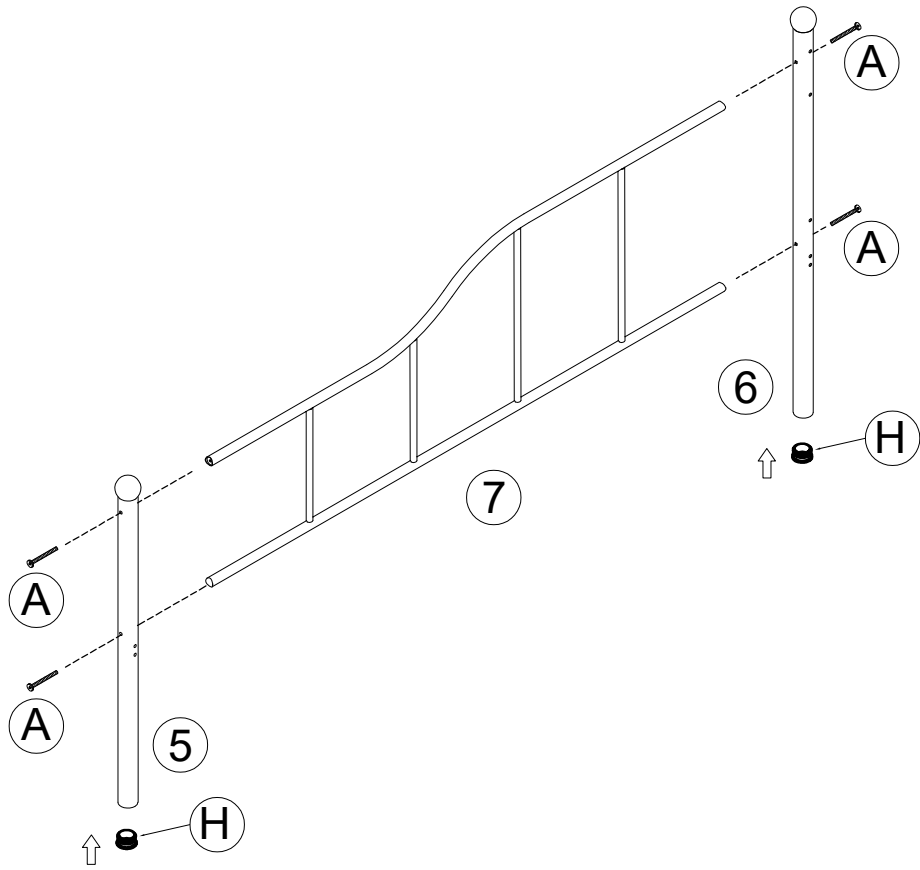

# STEP 1

2 SET



The other side should be assembled as the same way

CODE	HARDWARE	QTY
A	 M $\frac{1}{4}$ 'x45	8
H	 Ø38x20	4

# STEP 2

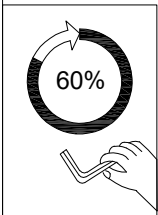
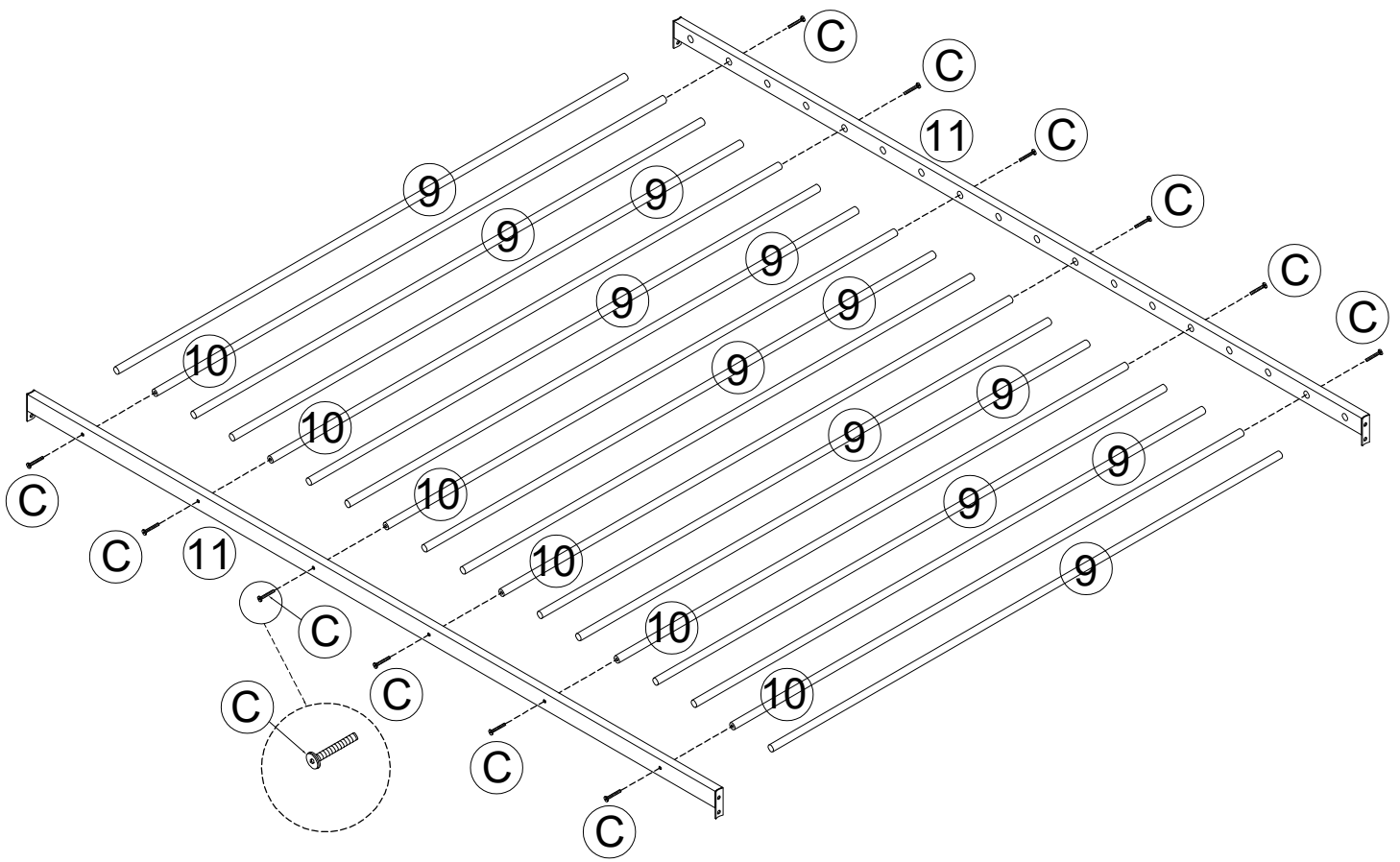

	CODE	HARDWARE	QTY
	C	 M $\frac{1}{4}$ x20	12

**STEP 3**      Joint the headboard and footboard together with the bed base

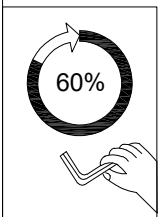
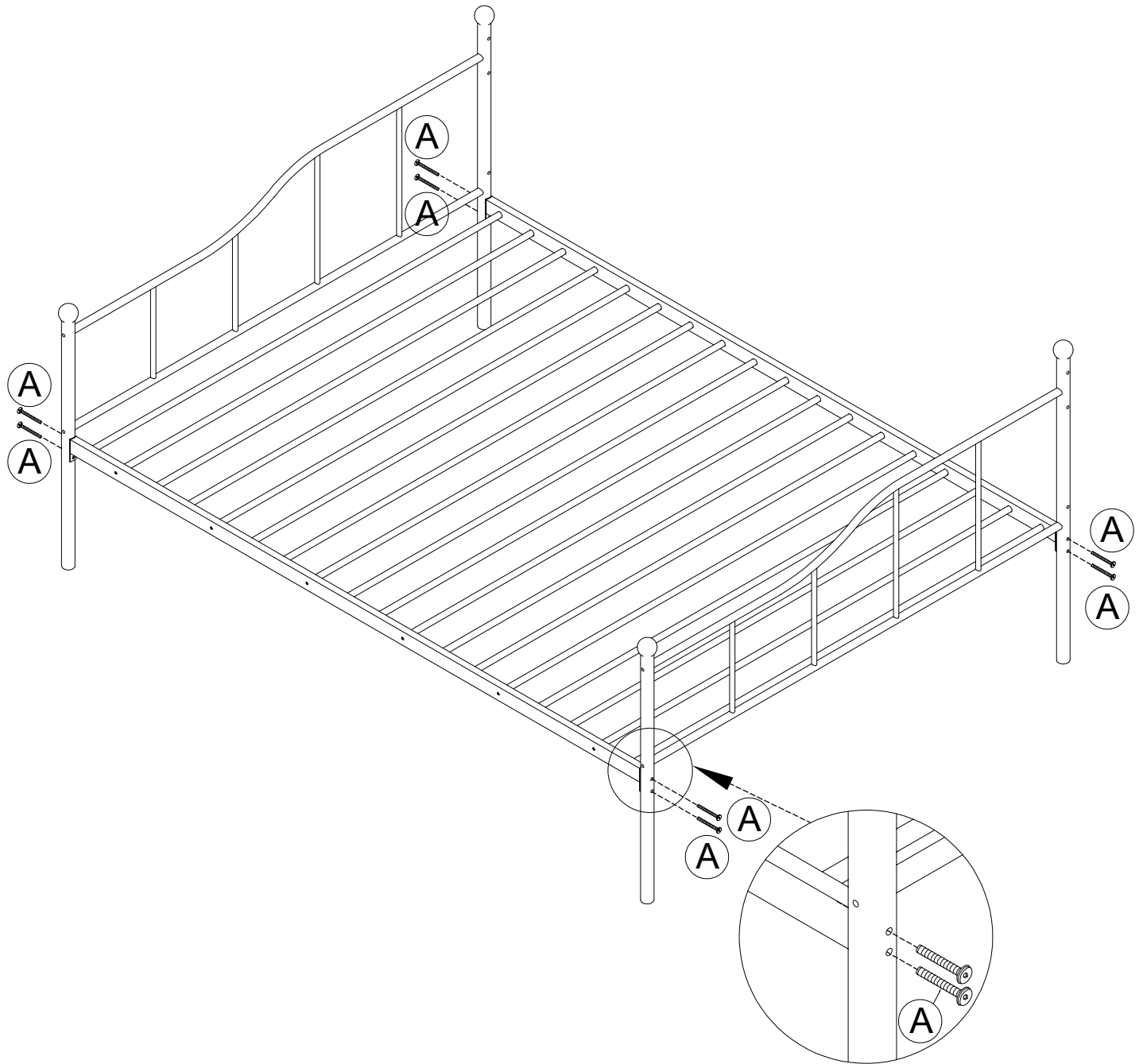

	CODE	HARDWARE	QTY
	A	 M $\frac{1}{4}$ x45	8

# STEP 4

## Assemble the bracket

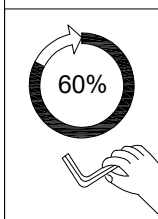
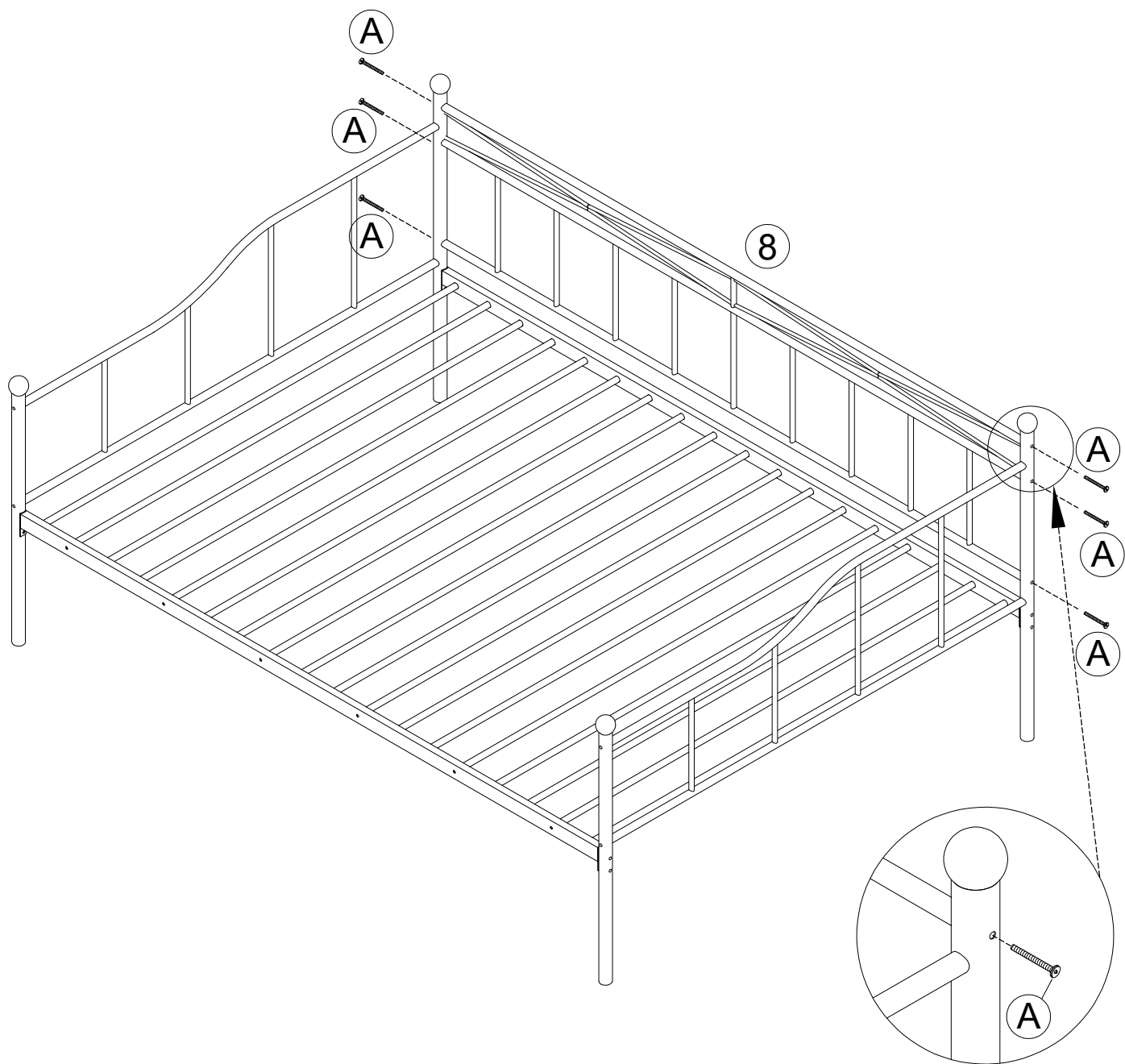

CODE	HARDWARE	QTY
A	 M <sup>1</sup> / <sub>4</sub> x45	6

# STEP 5

# 2SET

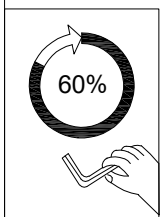
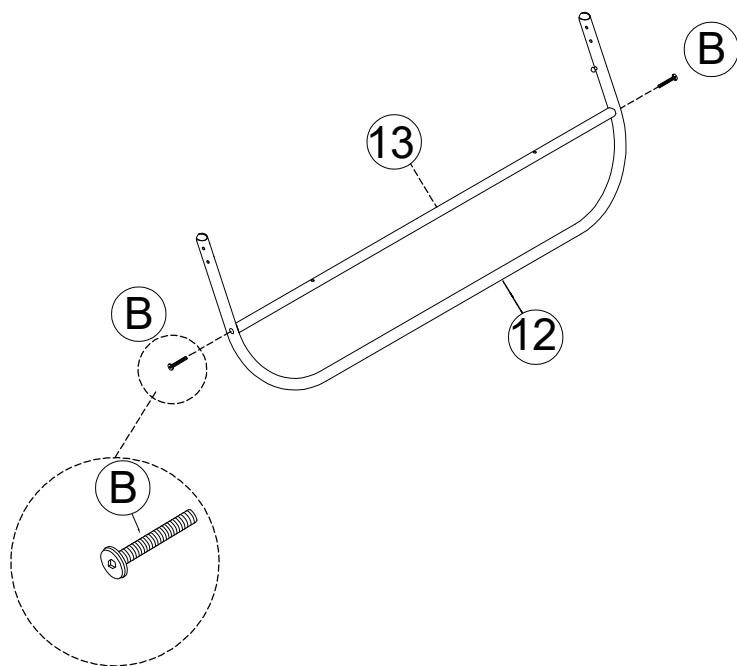

	CODE	HARDWARE	QTY
	B	 M $\frac{1}{4}$ 'x35	4

# STEP 6

# Assemble the put-down bed base

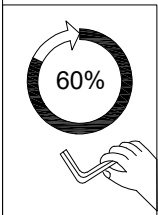
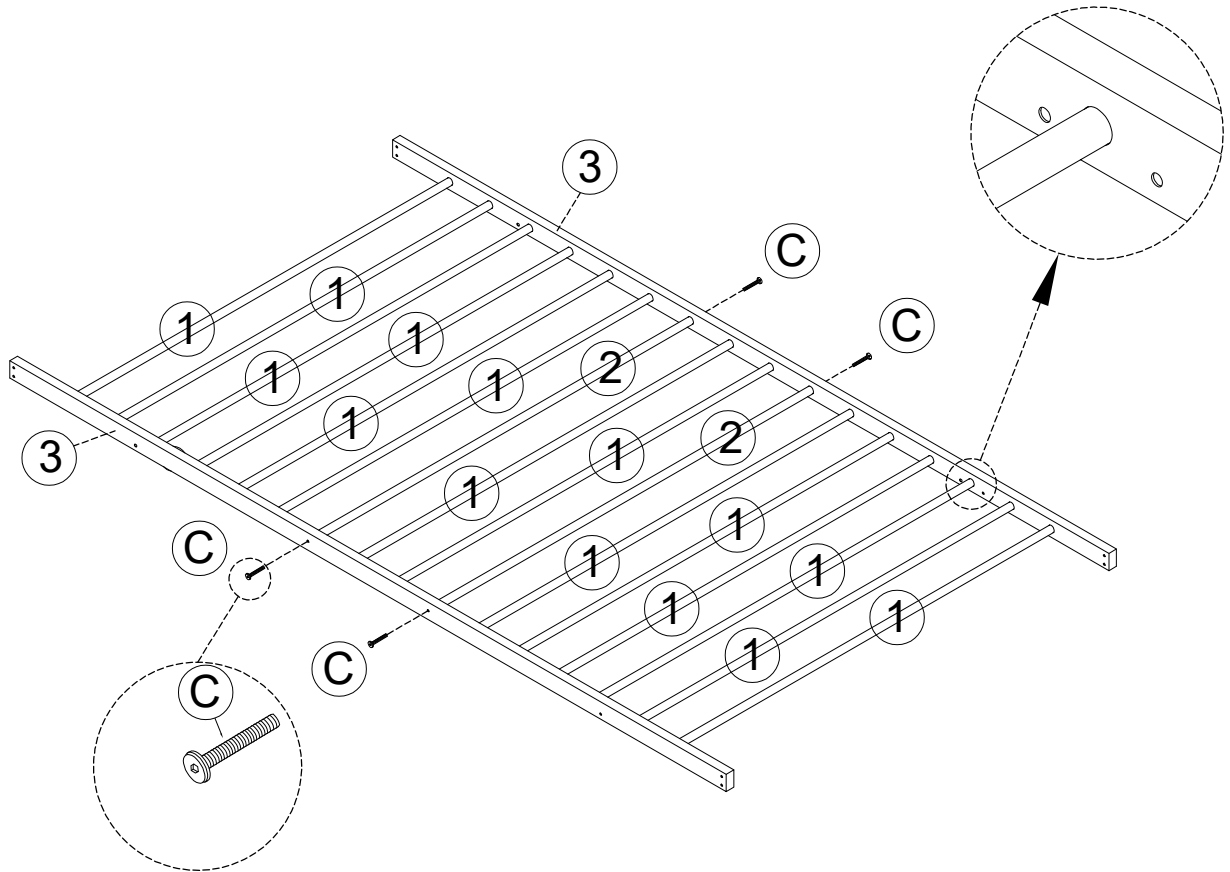

	CODE	HARDWARE	QTY
	C	 M <sub>4</sub> <sup>1</sup> x 20	4



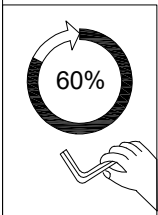
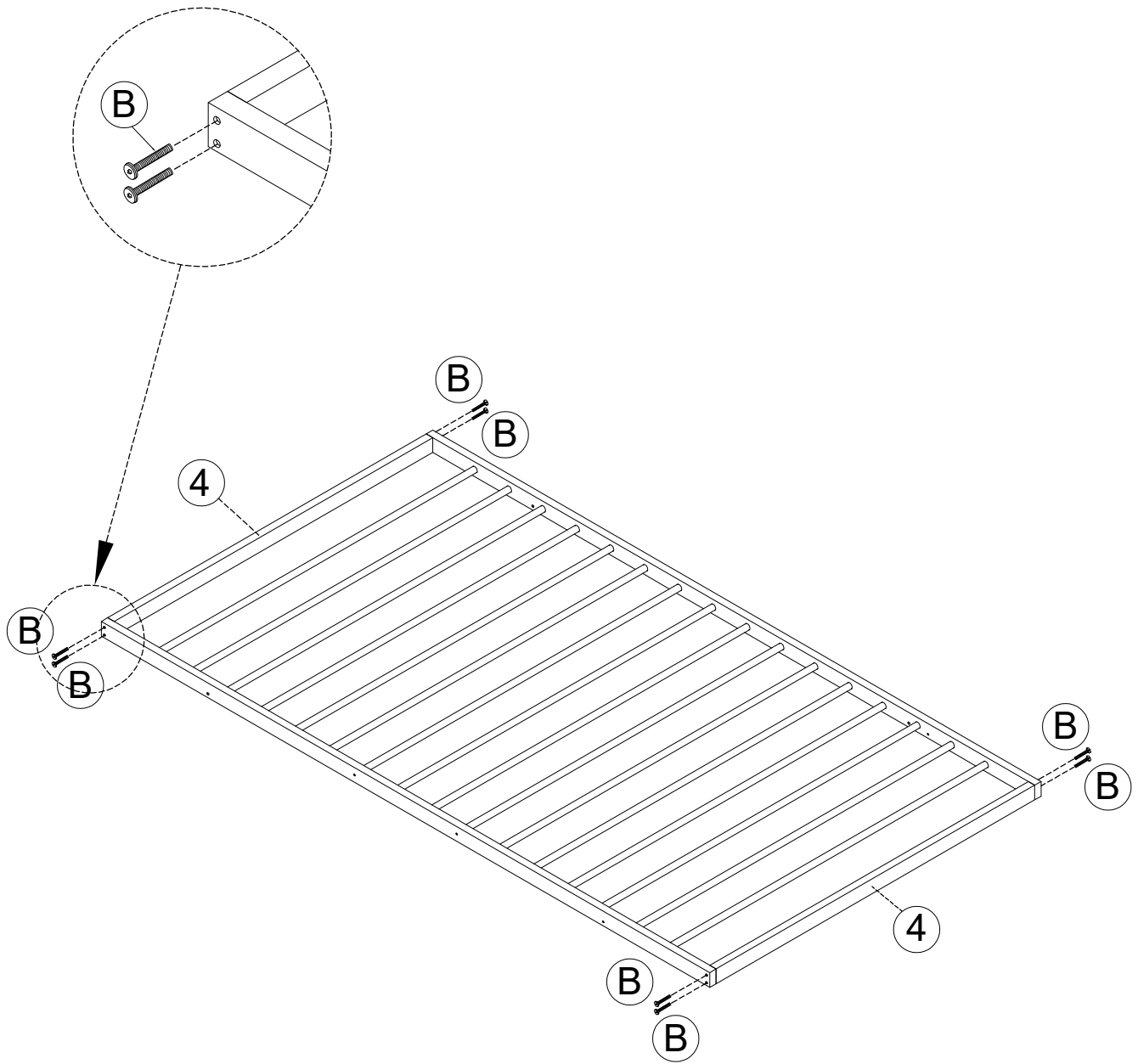

# STEP 7

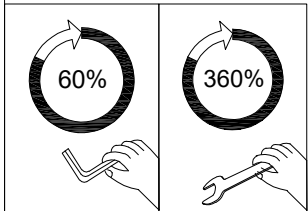
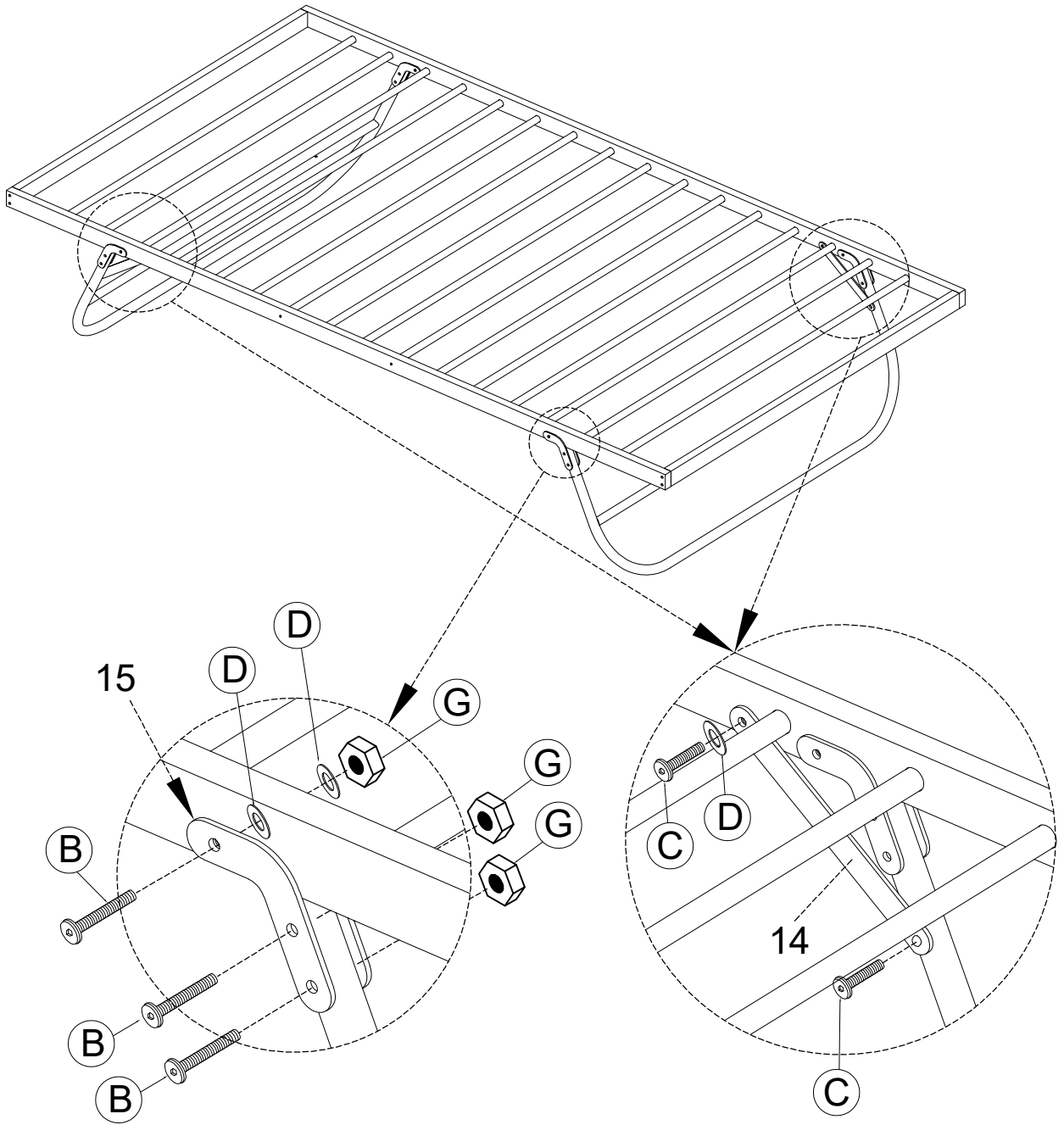

	CODE	HARDWARE	QTY
	B	 M $\frac{1}{4}$ 'x35	8

# STEP 8





CODE	HARDWARE	QTY	CODE	HARDWARE	QTY
C	 M $\frac{1}{4}$ "x20	4	G	 M $\frac{1}{4}$ "x10x5	12
B	 M $\frac{1}{4}$ "x35	12			
D	 Ø6x19X1.5	10			

# STEP 9

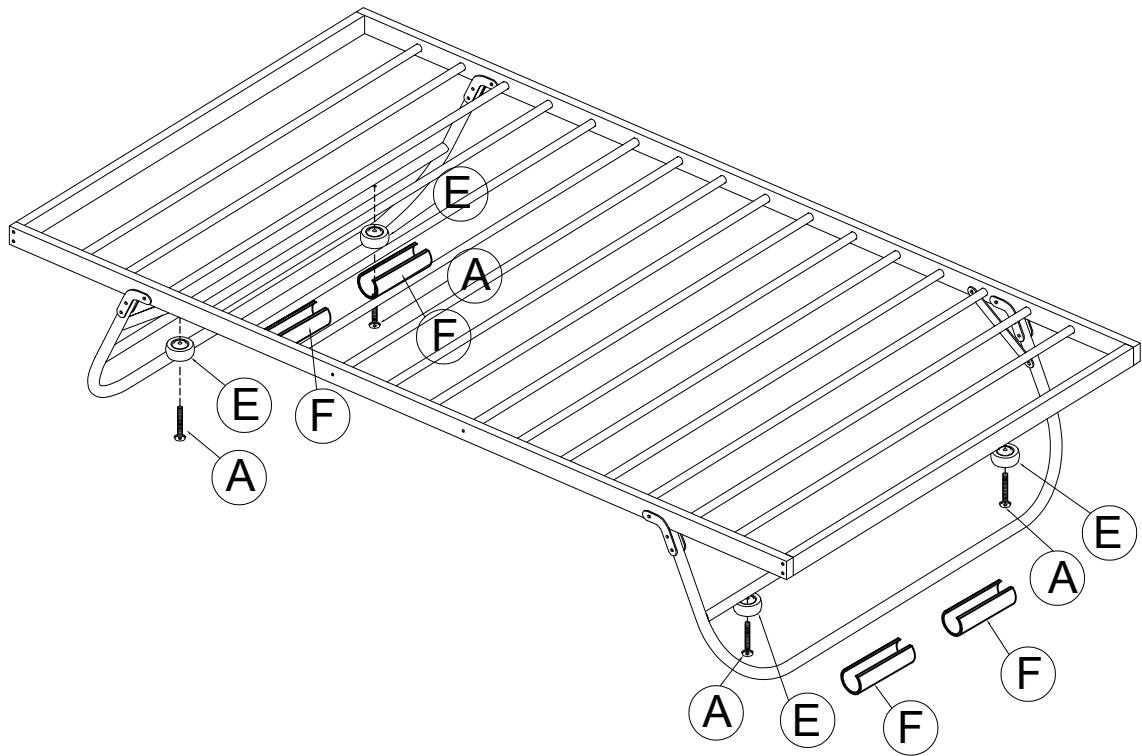
## Install the non mat M



CODE	HARDWARE	QTY
A	 M $\frac{1}{4}$ x45	4
E		4
F		4

