

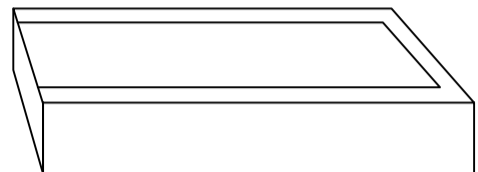

Accessories list

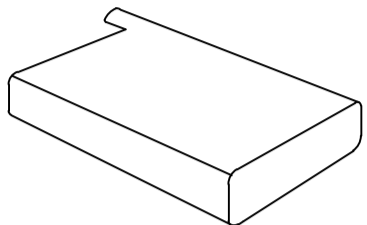

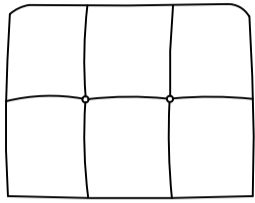

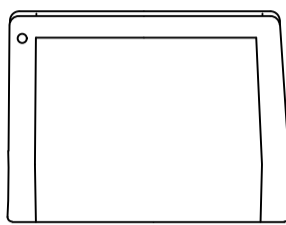
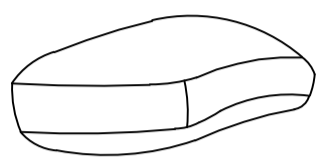
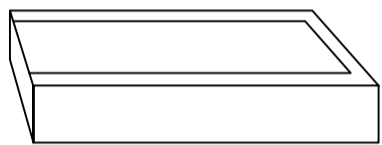
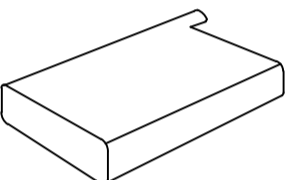
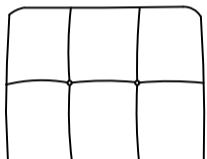
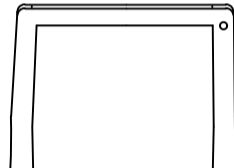

Carton 1/3

<p>A</p>  <p>Left seat frame(1)</p>	<p>B</p>  <p>Left seat cushion(1)</p>	<p>C</p>  <p>Backrest cushion(1)</p>	<p>D</p>  <p>Left backrest(1)</p>	<p>E</p>  <p>Left armrest soft bag(1)</p>
--	--	--	--	--

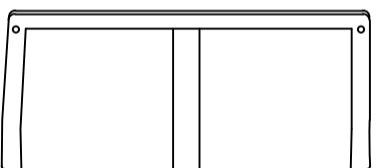
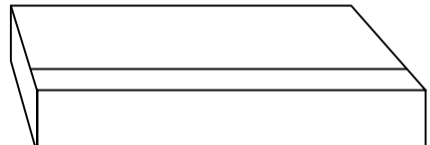
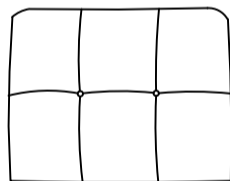
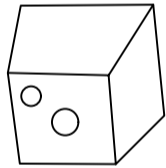
Carton 2/3

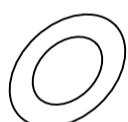
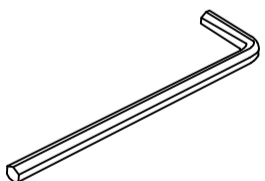
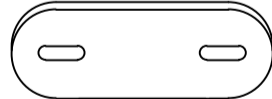
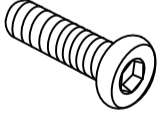
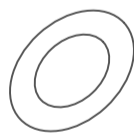
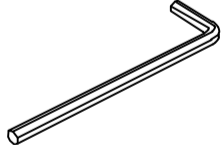
<p>F</p>  <p>Right seat frame(1)</p>	<p>G</p>  <p>Right seat cushion(1)</p>	<p>C</p>  <p>Backrest cushion(1)</p>	<p>H</p>  <p>Right backrest(1)</p>	<p>X</p>  <p>Right armrest soft bag(1)</p>
---	---	--	---	---

Carton 3/3

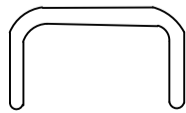
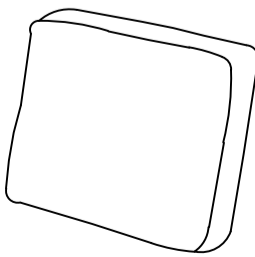
<p>I</p>  <p>Middle backrest(1)</p>	<p>J</p>  <p>Double seat frame(1)</p>	<p>C</p>  <p>Backrest cushion(2)</p>	<p>K</p>  <p>8*80mm Leg(12)</p>	<p>L</p>  <p>8*95 Screw(12)</p>	<p>M</p>  <p>17mm Gasket(12)</p>
<p>N</p>  <p>M5*100*40mm Wrench(1)</p>	<p>O</p>  <p>50 Metal plate(2)</p>	<p>P</p>  <p>6*25 Screw(4)</p>	<p>Q</p>  <p>13mm Gasket(4)</p>	<p>R</p>  <p>M4*65*23 Wrench(1)</p>	
<p>S</p>  <p>Hardware(6)</p>	<p>T</p>  <p>6*35 Screw(24)</p>	<p>U</p>  <p>17mm Gasket(24)</p>	<p>V</p>  <p>U connector(2)</p>	<p>W</p>  <p>Seat cushion(2)</p>	

STEP 1:

Connect the sofa seat frame with U hooks

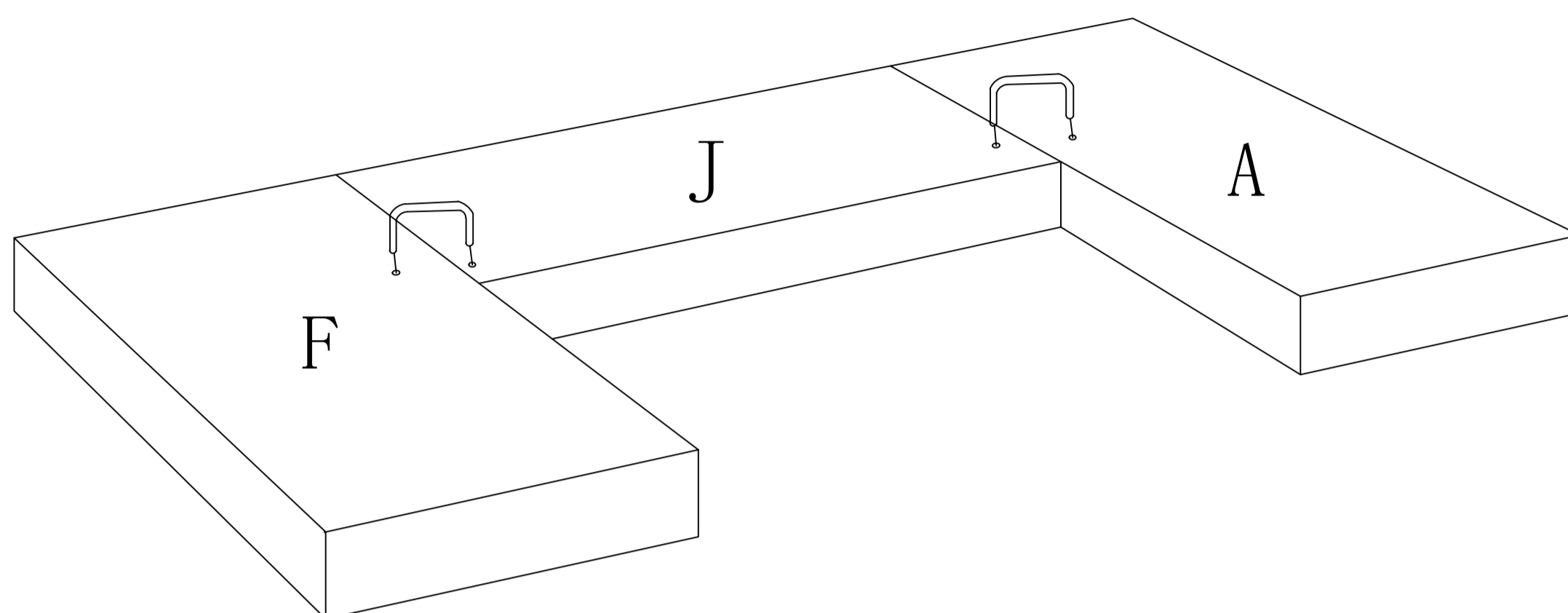

STEP 2:

Install the backrest hardware on the seat frame of the sofa

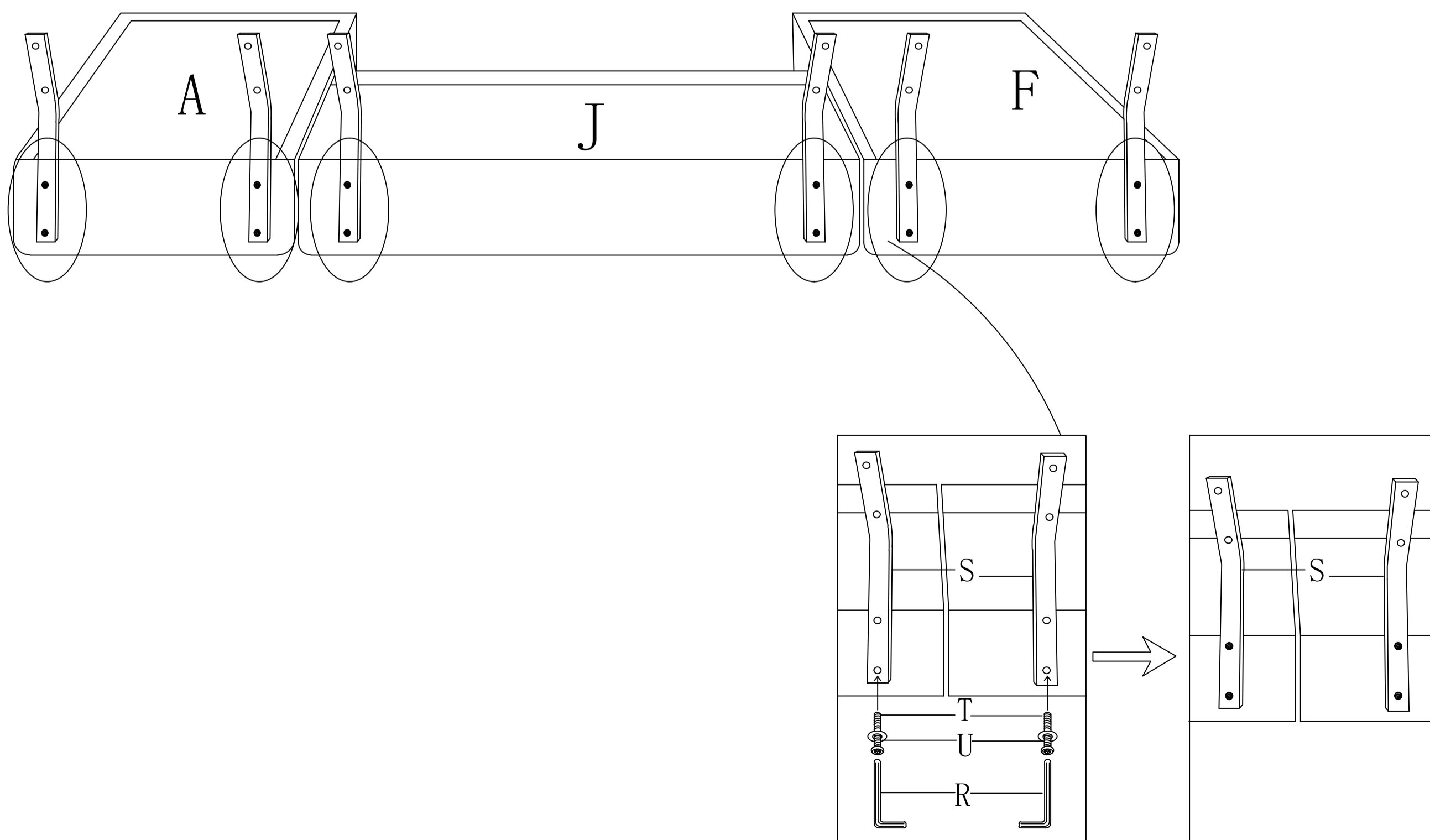

STEP 3:

Align the installing holes of the sofa backrest with the hardware holes

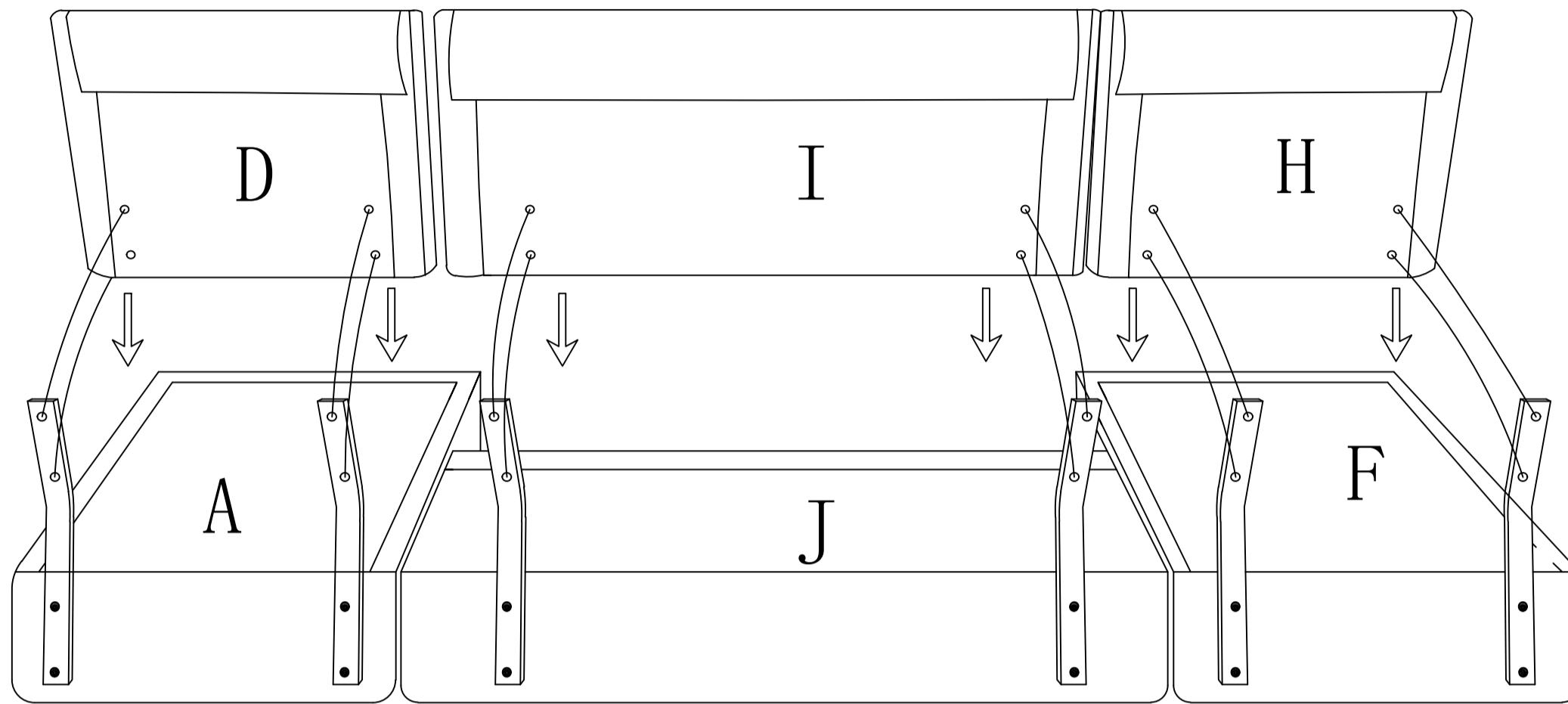

STEP 4:

Install screws to lock the sofa backrest

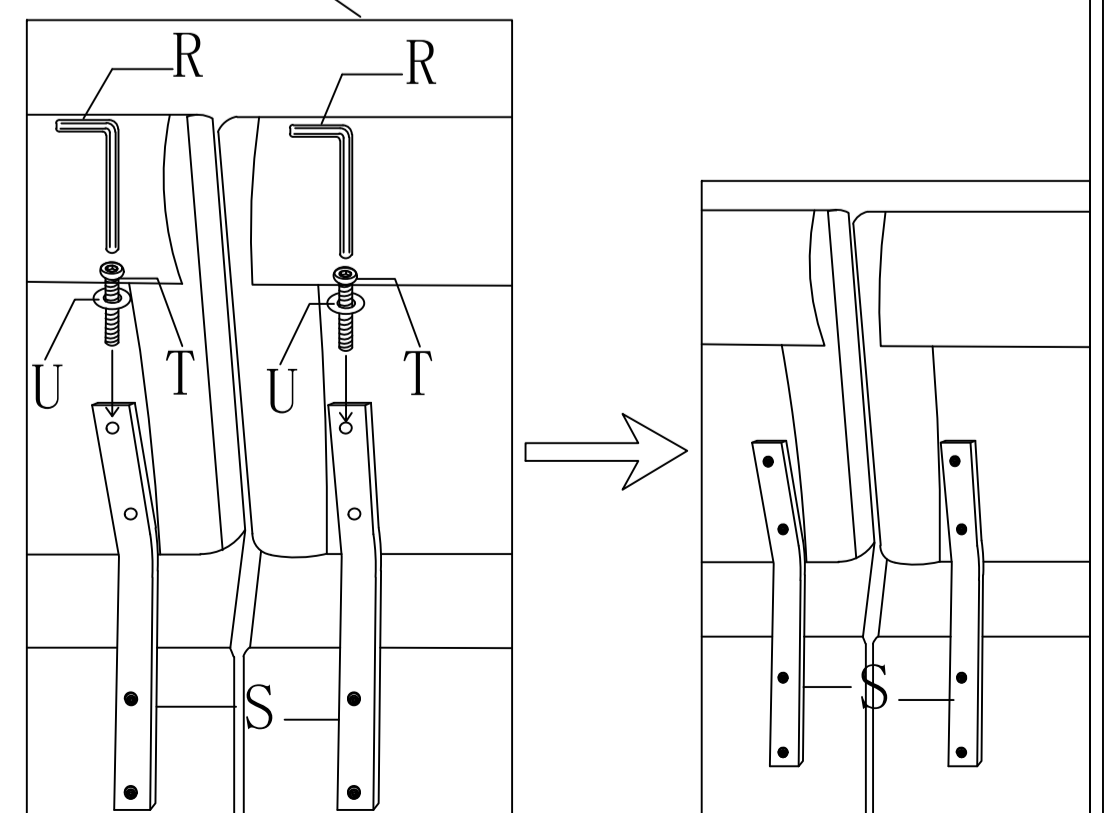
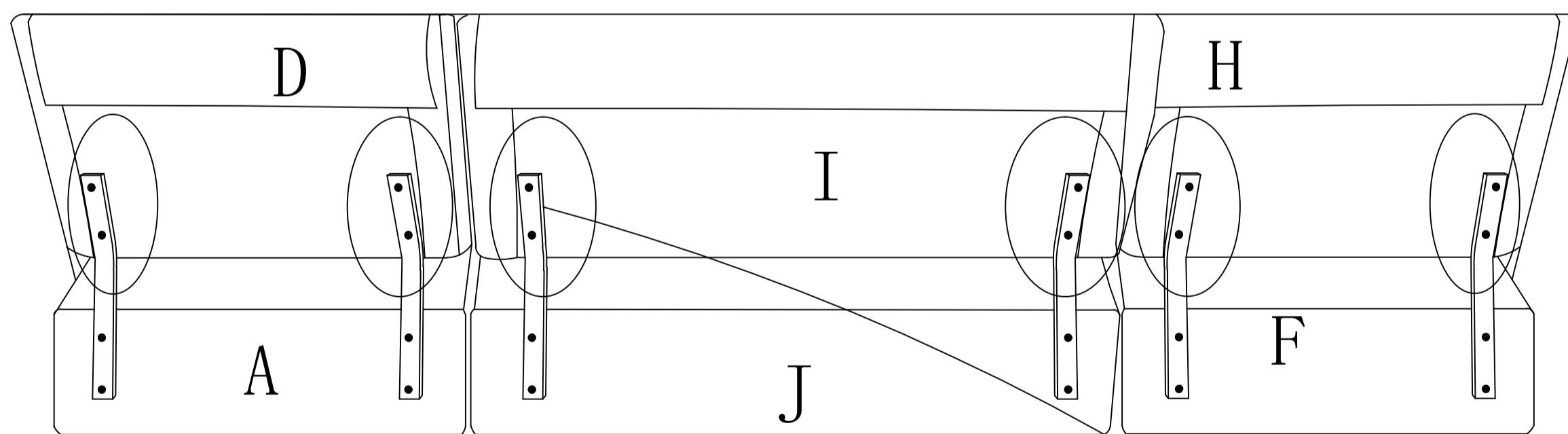

STEP 5:

Stick the Velcro on the back cloth of the sofa under the seat frame

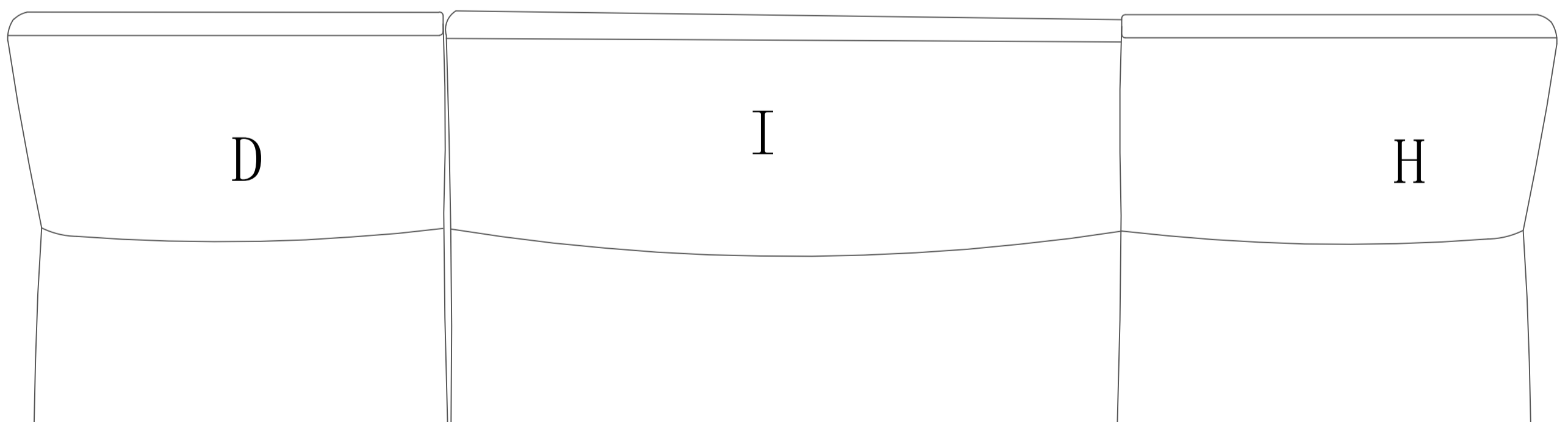
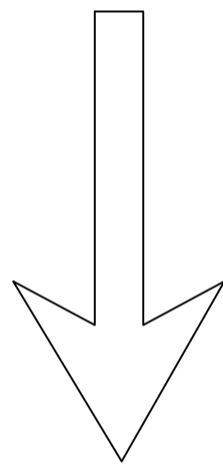
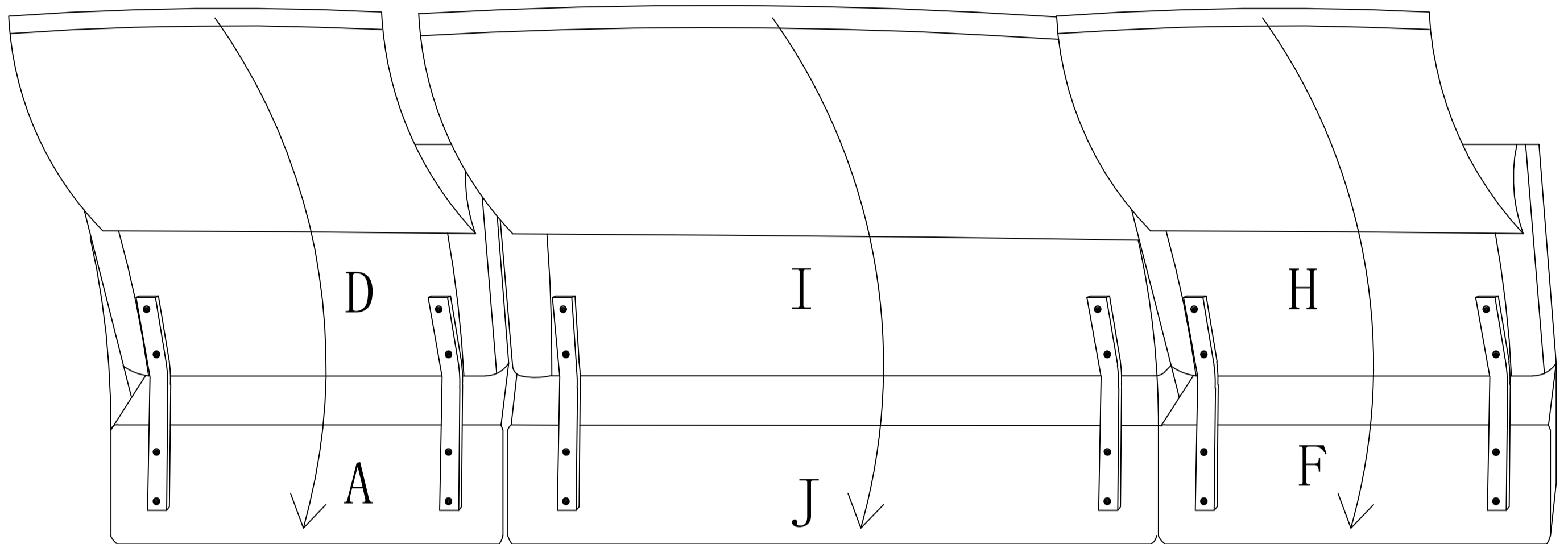

STEP 6:

Lock the backrest with the metal plate

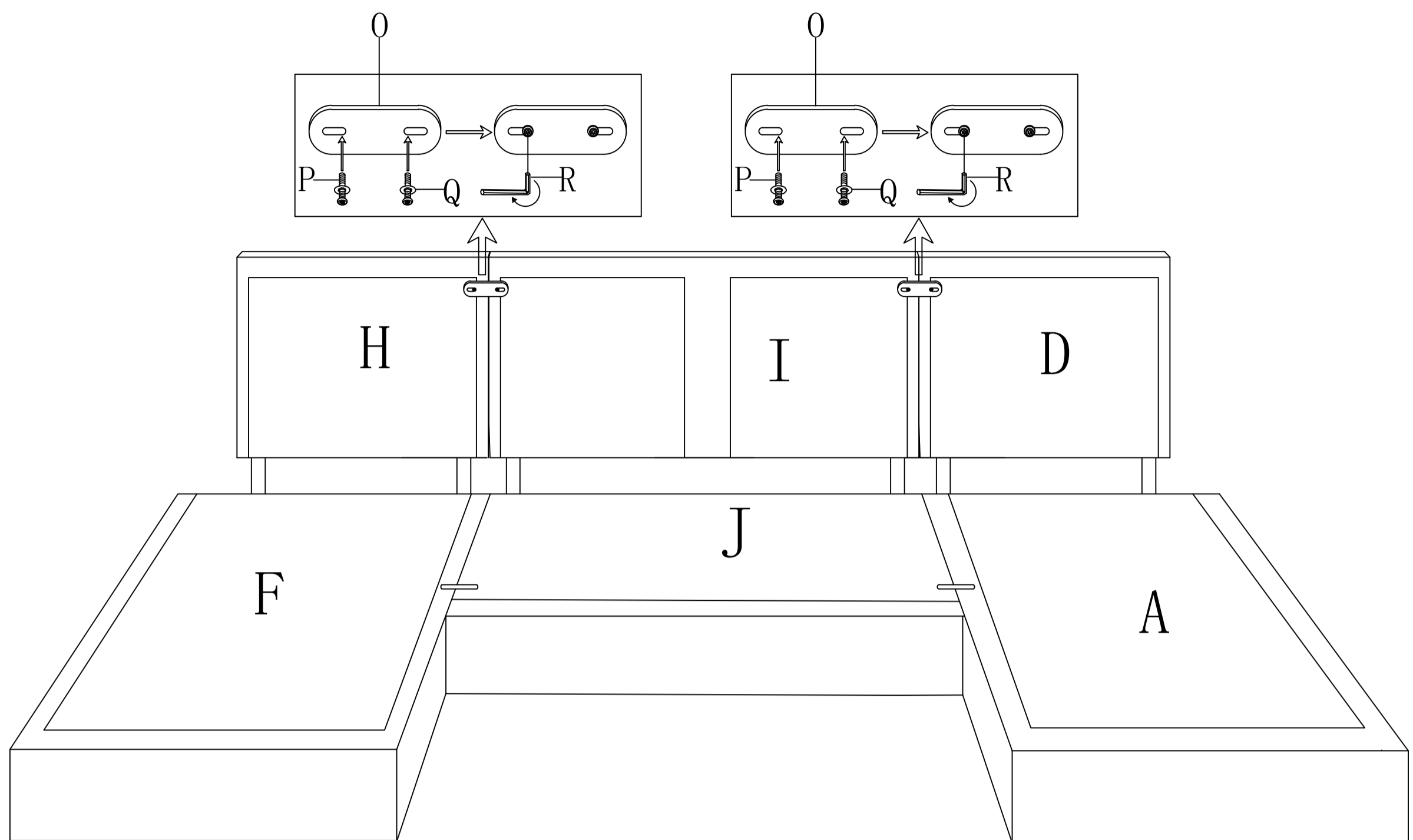

STEP 7:

Install the 12 legs under the seat frame

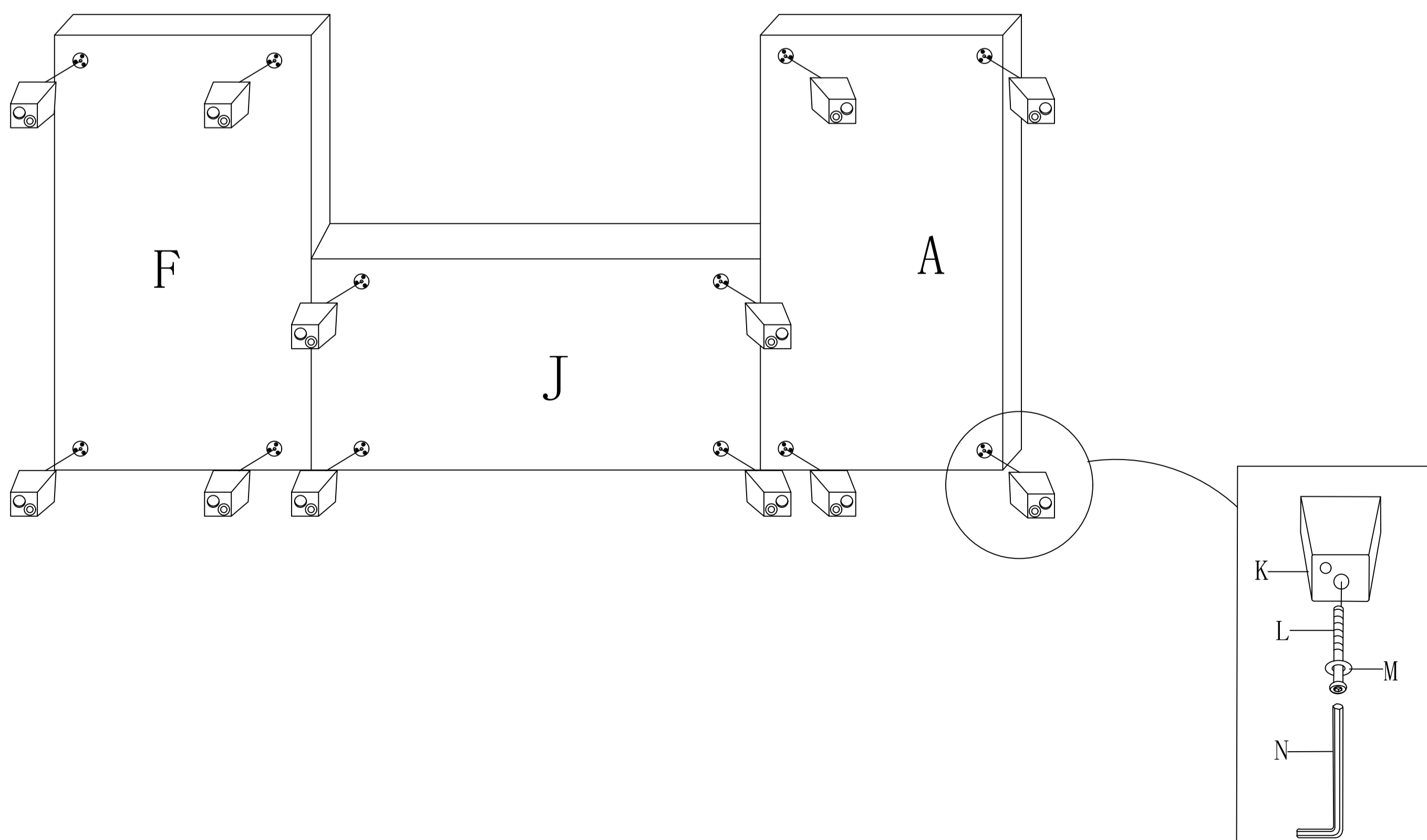

STEP 8:

Open the compression bags with the scissor(Notice: if you don't like the sofa assembled and want to return it, please don't open the compression bags, it's hard to pack back, thanks)

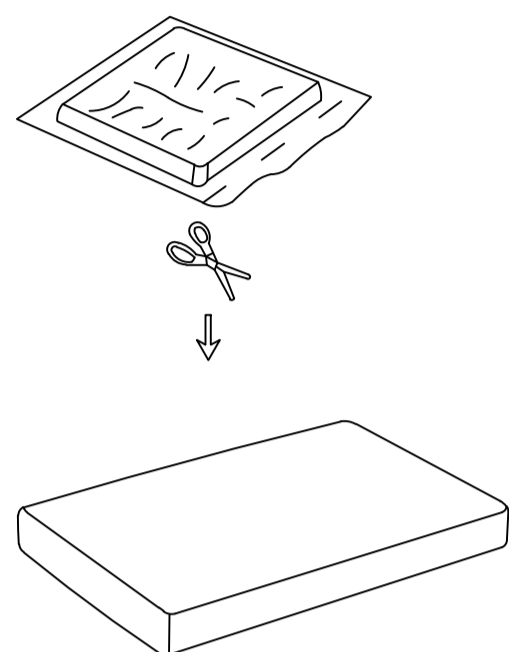

Left seat frame*1

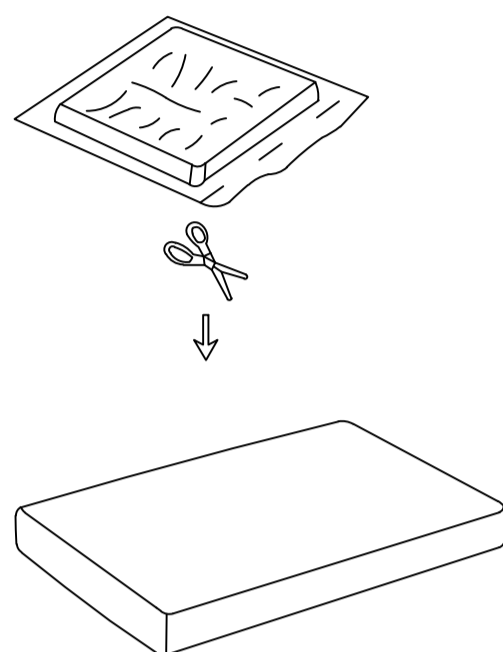

Right seat frame*1

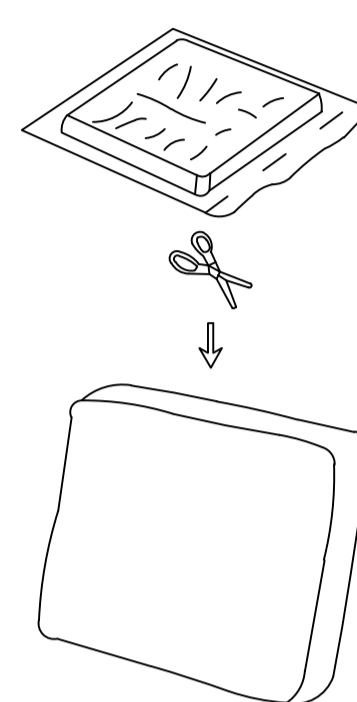

Seat cushion*2

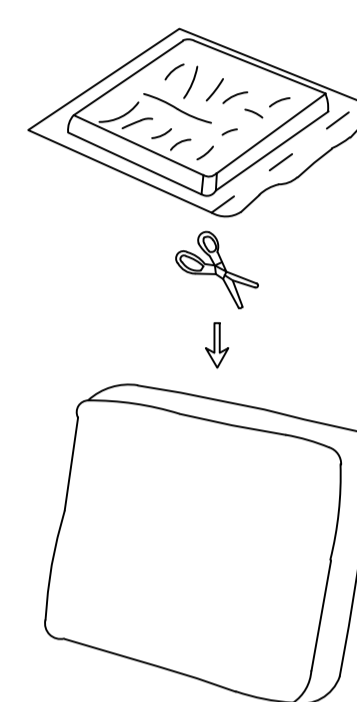

Back Cushion*4

STEP 9:

Zip the armrest pillows to the armrest

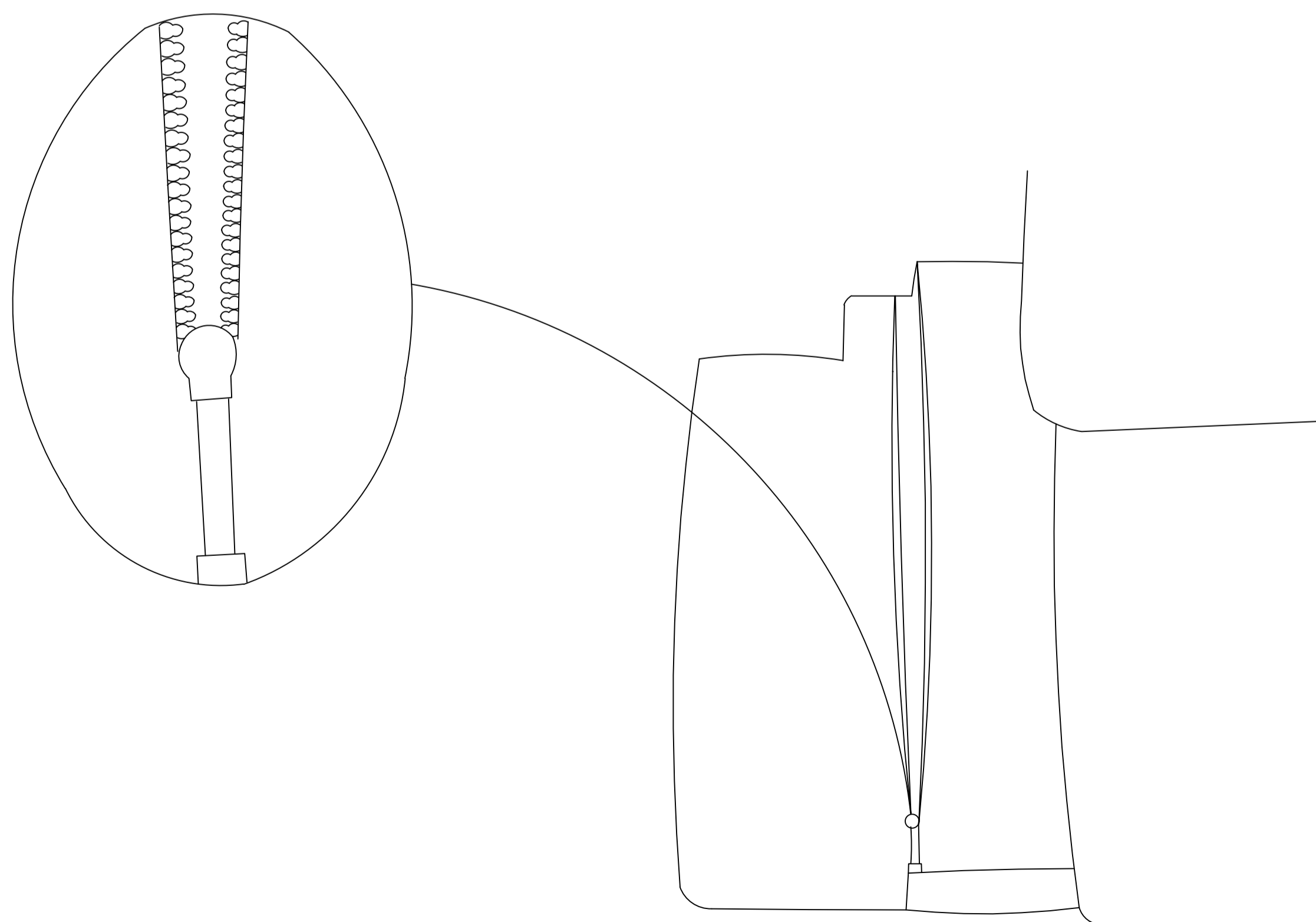

Sofa legs and backrest hardware accessories are placed in the 3/3 two seat frame

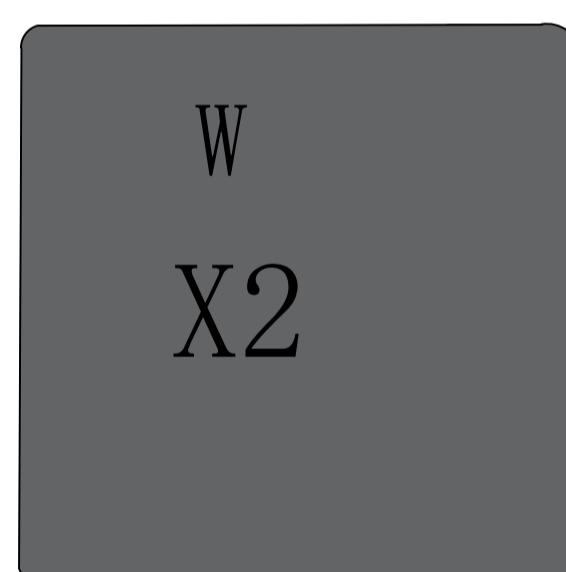
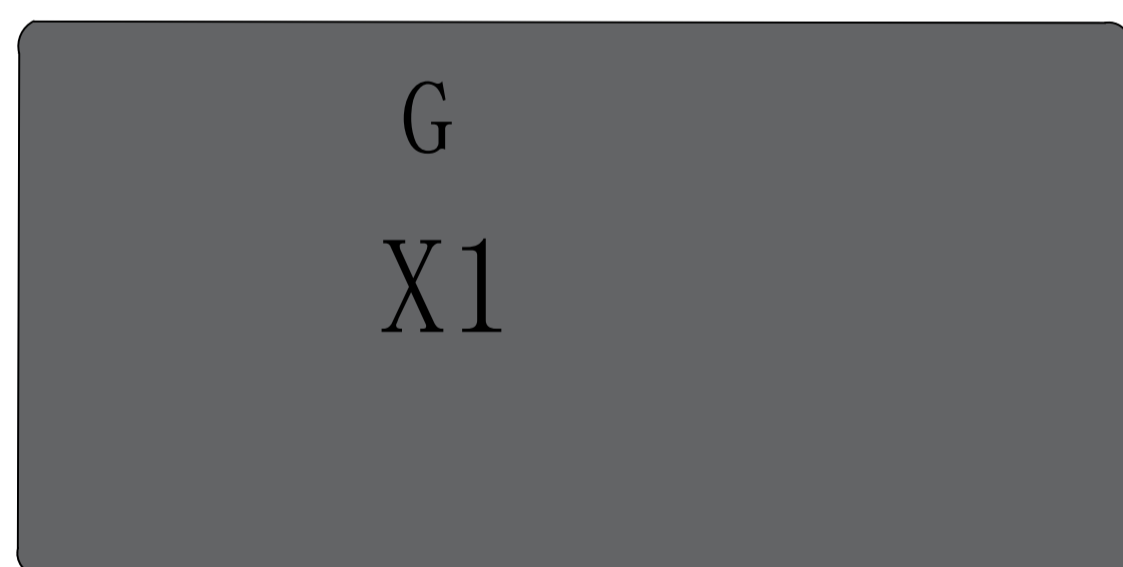
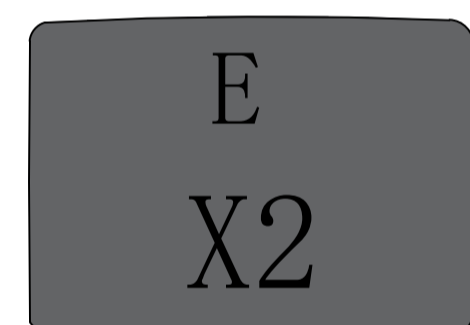
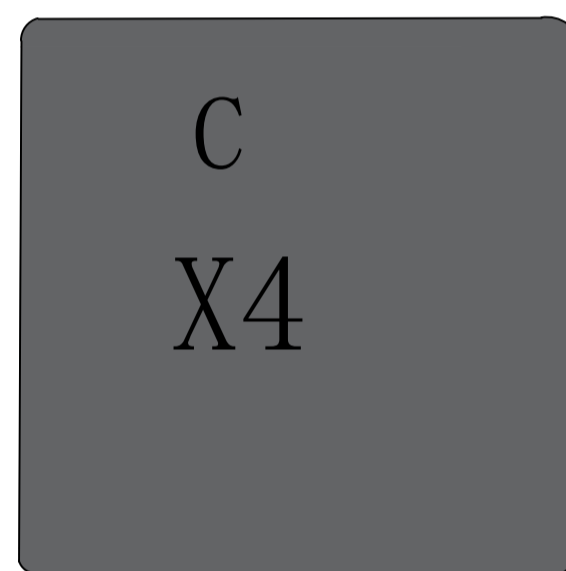
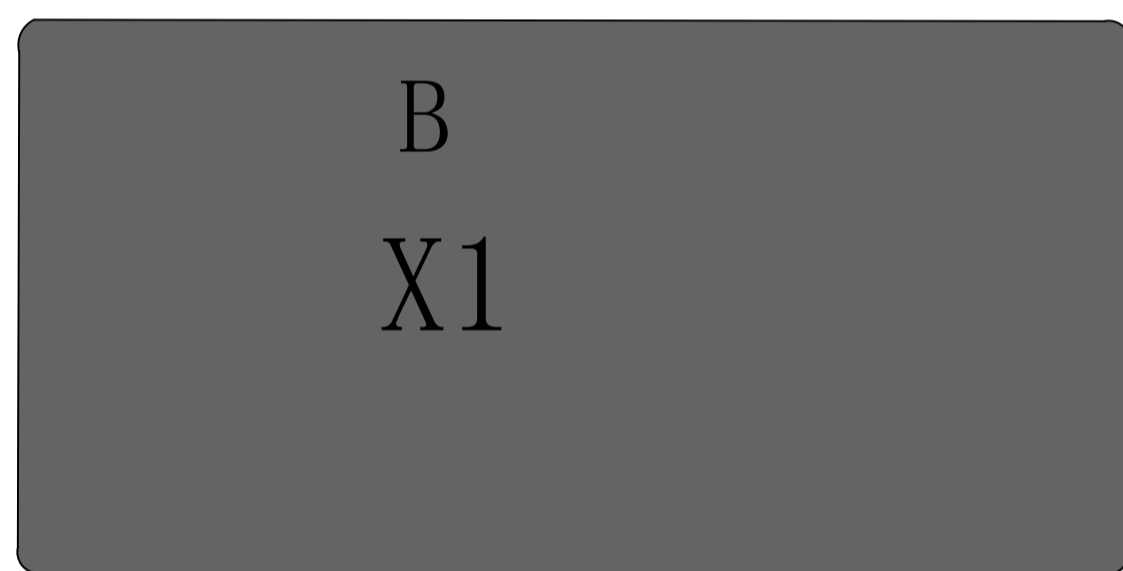
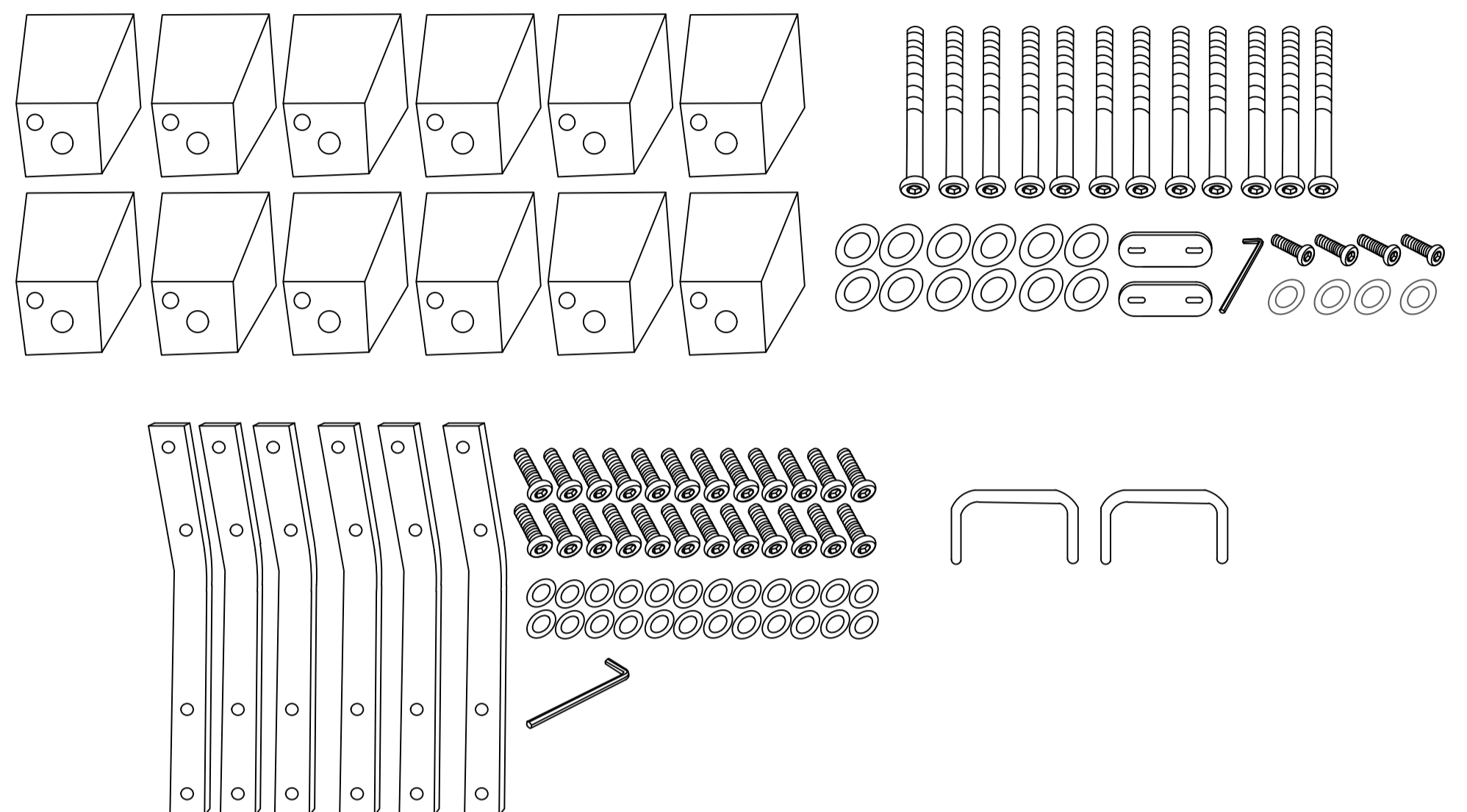

1. A large cushion bag, a small backrest backpack, and a left armrest placed in 1/3 of the left seat frame
2. A large cushion bag, a small backrest backpack, and a right armrest placed in 2/3 of the right seat frame
3. Two small seat bags and two small backrest backpacks placed in the 3/3 two seat frame

STEP 10:

Assembly completed

