

# Assembly Manual

## 3-person seat

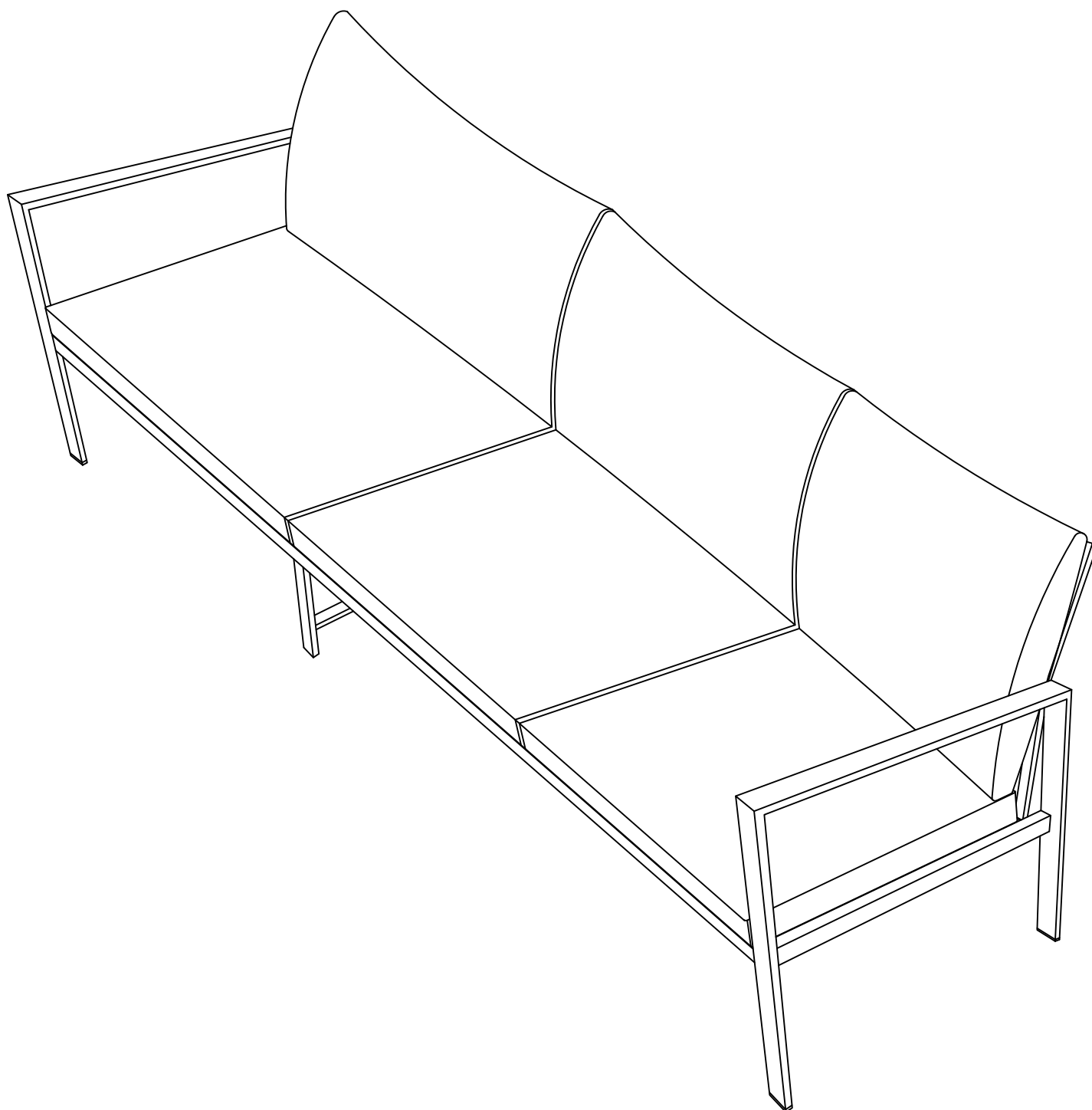

Please read this manual carefully before any operation and keep it properly for future use.

# Exploded View

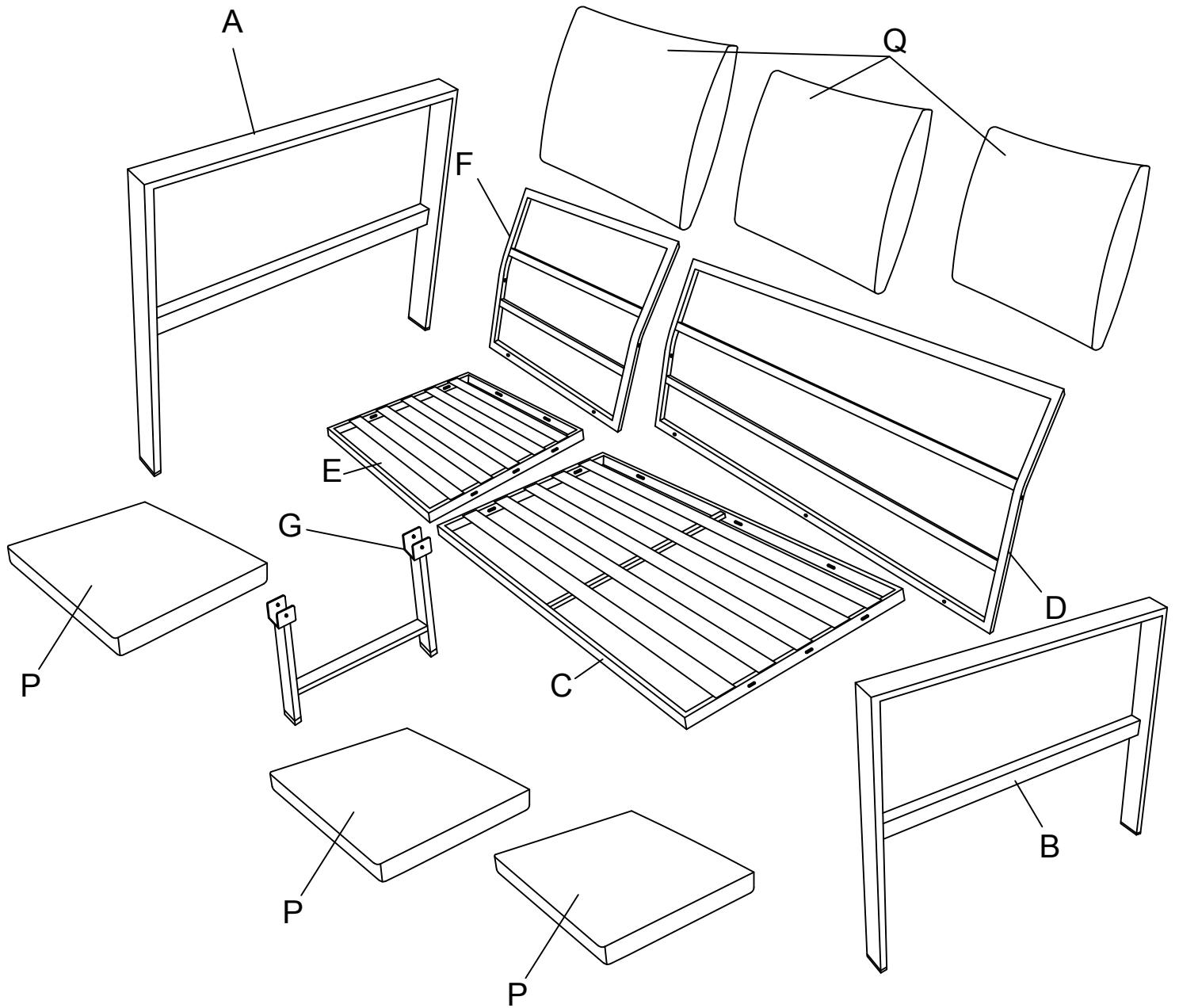

# Components List

A

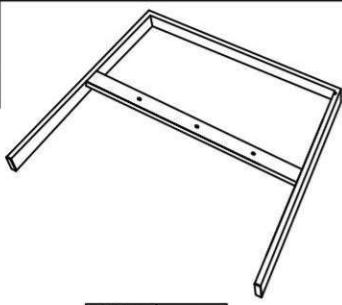

Right Armrest 1PC

B

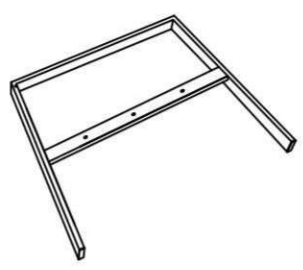

Left Armrest 1PC

C

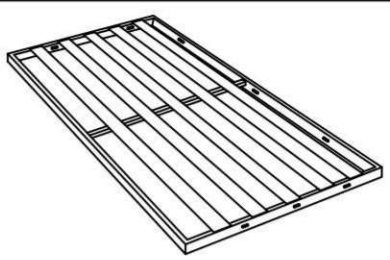

Double Seat 1PC

D

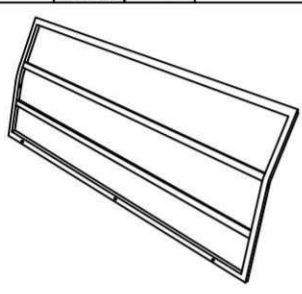

Double Back 1PC

E

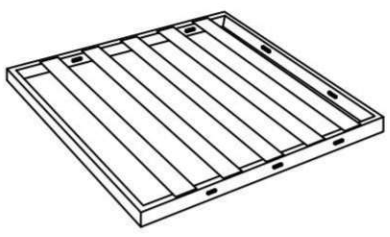

Seat 1PC

F

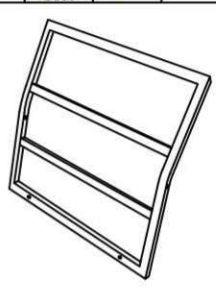

Back 1PC

G

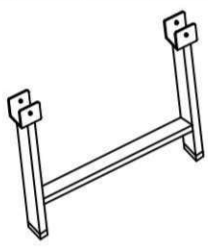

Leg 1PC

H

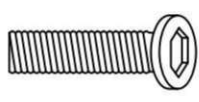

Bolt M6X25 11+2 PCS

I

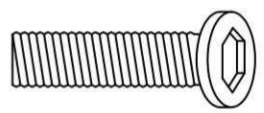

Bolt M6X40 2+1 PCS

J

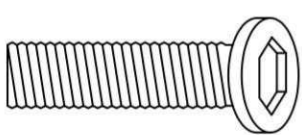

Bolt M6X50 2+1 PCS

K

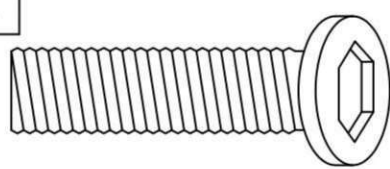

Bolt M6X65 2+1 PCS

L

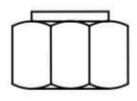

Nut M6 4+1 PCS

M



Washer M6 21+6 PCS

N



Allen wrench M6 1PC

O

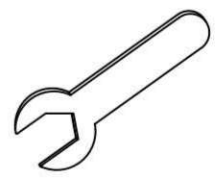

wrench M6 1PC

P

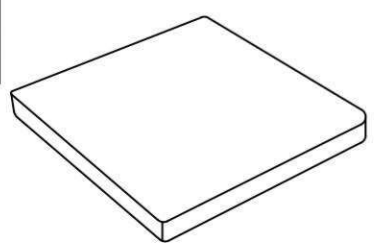

Seat Cushion 3PCS

Q

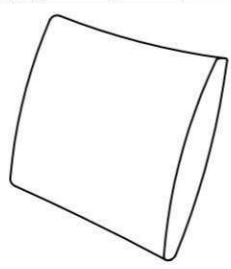



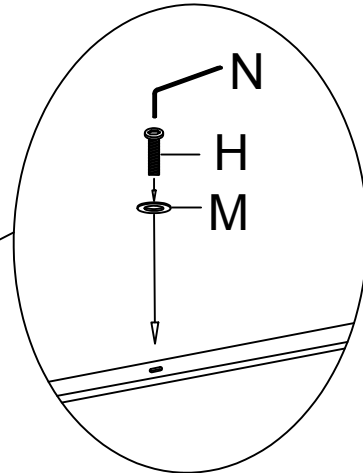
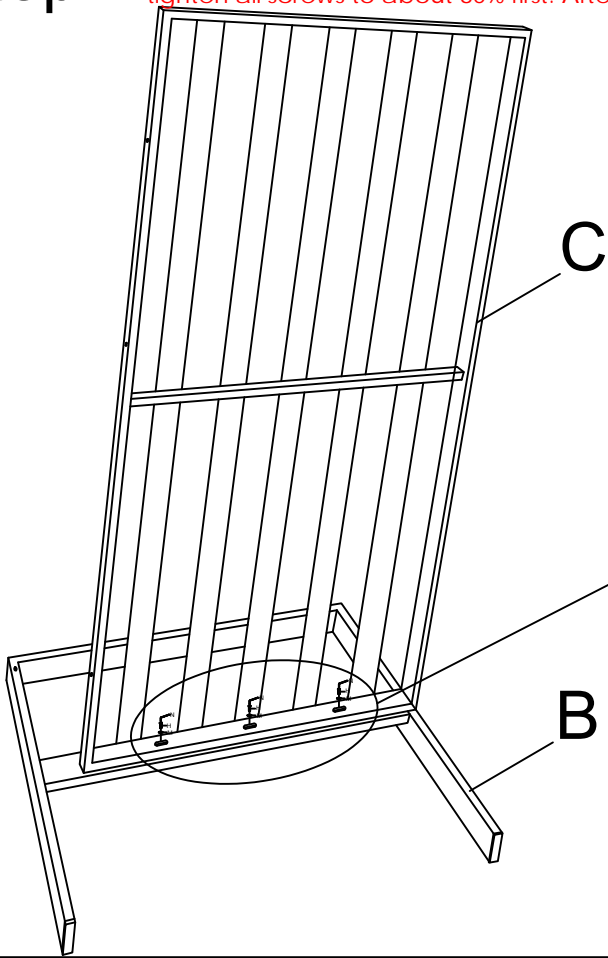

Back Cushion 3PCS

# ASSEMBLY INSTRUCTION





**Step 1** Attach left armrest(B) to the seat board(C) using washers(M), bolts(H) and Allen wrench(N). **Hand-tighten all screws to about 80% first. After all screws are in place, tighten them fully in sequence**

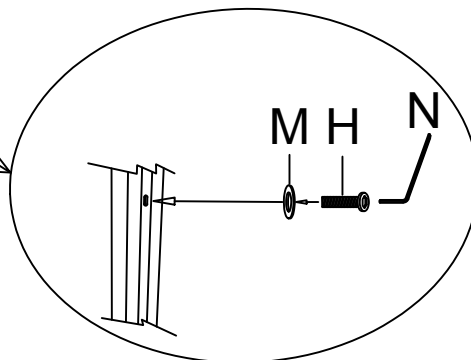
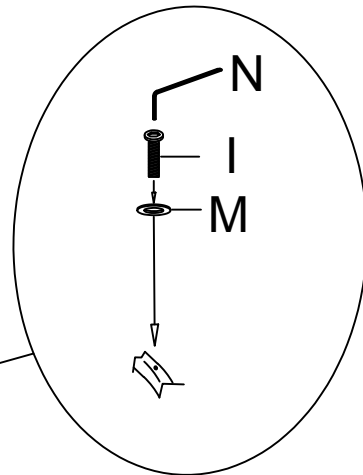
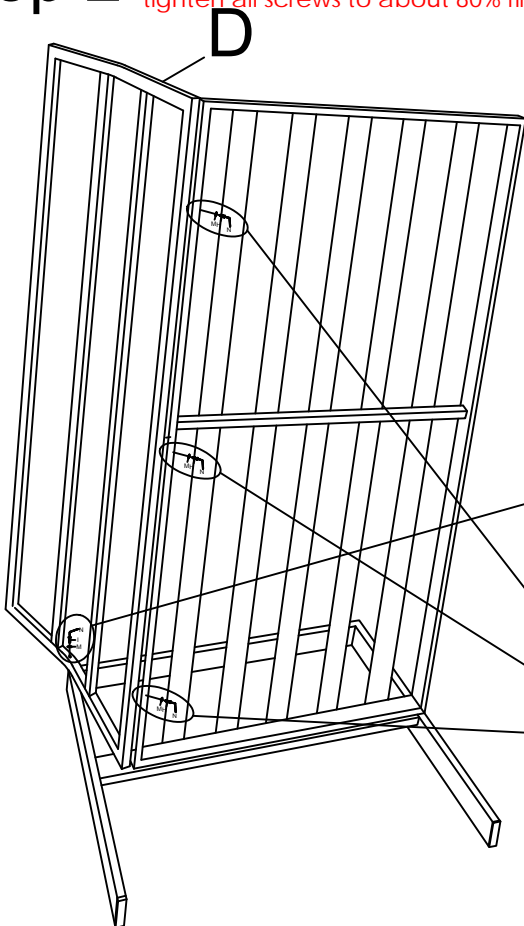

	BX1
	CX1
	HX3
	MX3
	NX1

**Step 2** Attach back frame(D) to the seat frame using washers(M), bolts(H&I), and Allen wrench(N). **Hand-tighten all screws to about 80% first. After all screws are in place, tighten them fully in sequence**



	DX1
	HX3
	IX1
	MX4
	NX1

# ASSEMBLY INSTRUCTION

## Step 3

Attach back frame(F) to the seat frame(E) using washers(M), bolts(H), and Allen wrench(N). Attach single seat to the love seat frame using nuts(L), washers(M), bolts(K), and Allen wrench(N&O). Attach middle leg(G) to the seat frame using nuts(L), washers(M), bolts(J), and Allen wrench(N&O). **Hand-tighten all screws to about 80% first. After all screws are in place, tighten them fully in sequence**

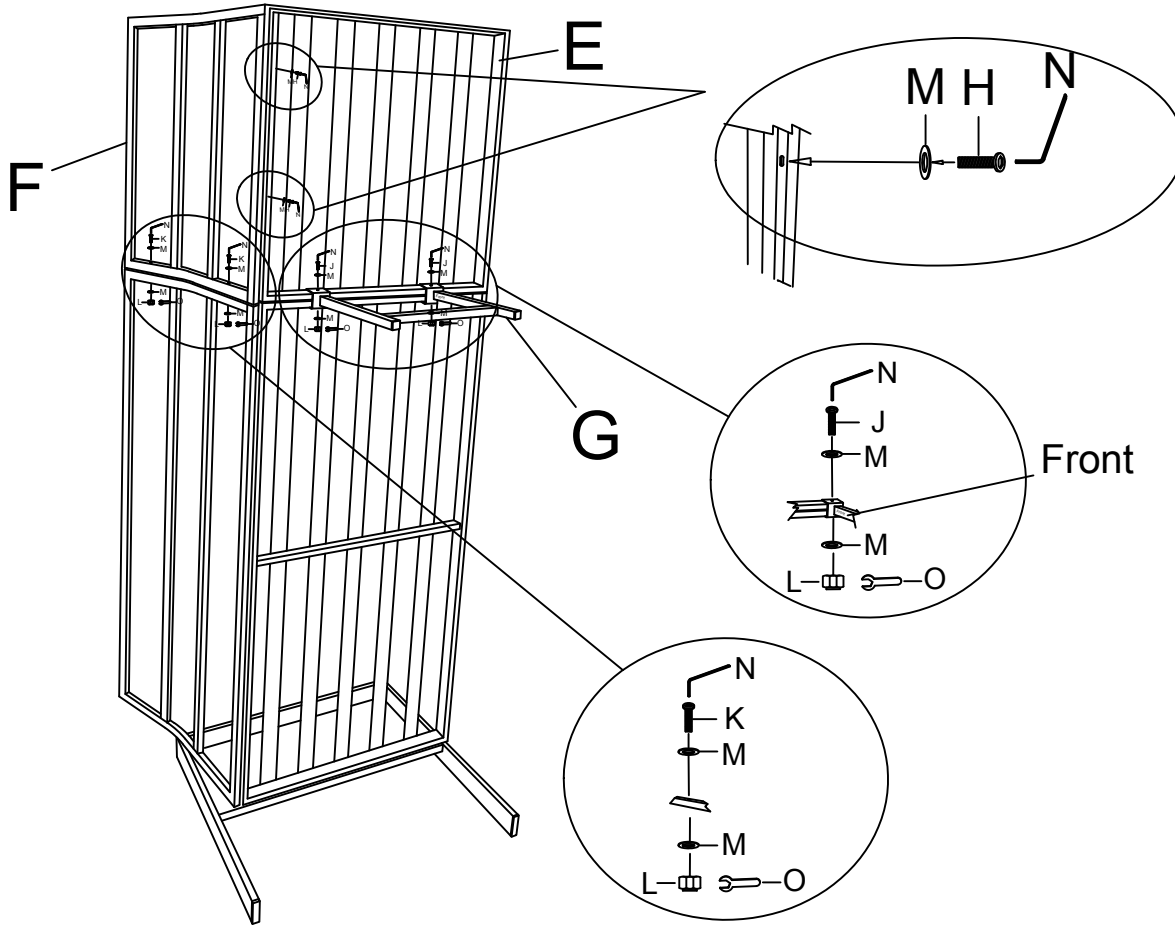

	EX1
	FX1
	GX1
	HX2
	JX2
	KX2
	MX10
	LX4
	NX1
	OX1

## Step 4

Attach right armrest(A) to the seat board(C) using washers(M), bolts(H&I) and Allen wrench(N). **Hand-tighten all screws to about 80% first. After all screws are in place, tighten them fully in sequence**

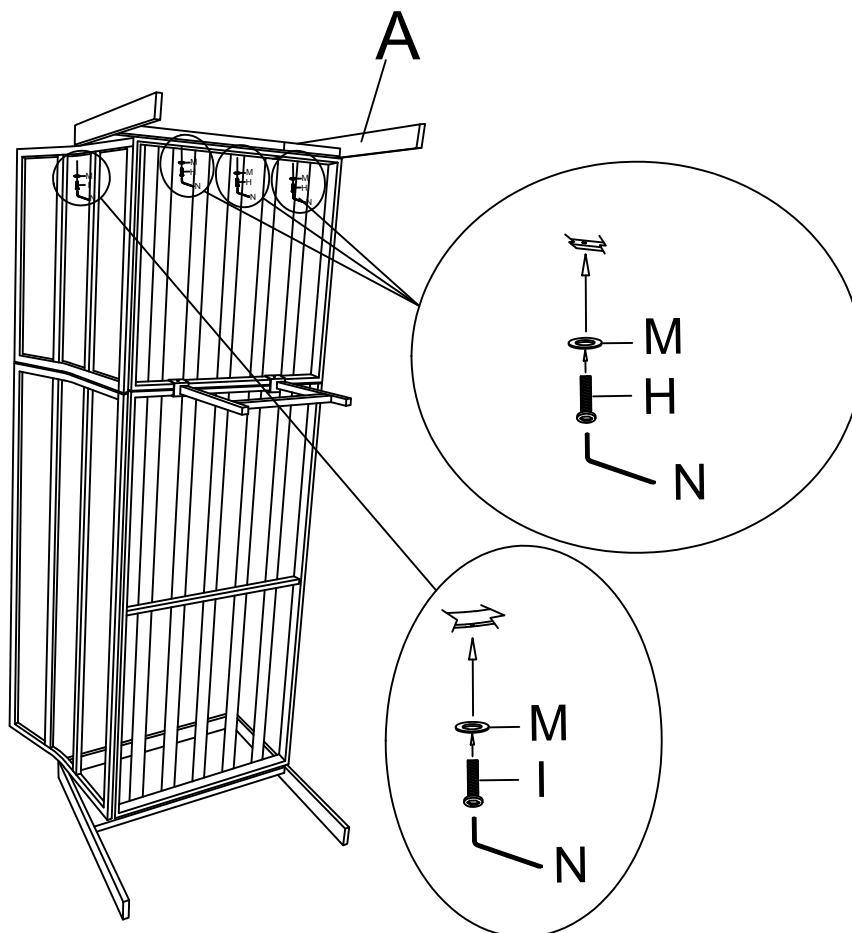

	AX1
	HX3
	IX1
	MX4
	NX1

# ASSEMBLY INSTRUCTION

## Step 5

Tighten all bolts 100%, and flip the seat over. Put the seat cushion(P) and back cushion(Q) on the seat frame. The assembly is done.

