





# Assembly Instructions

## CAUTION

**DO NOT** use any sharp objects to open plastic-wrapped components as this may result in damage to the product or components.

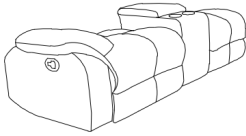
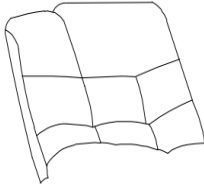
This product comes in three kinds of packages. Carefully remove all of components from the packaging and set aside for assembly.

## Package Contents

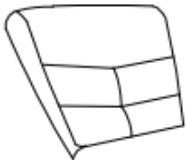
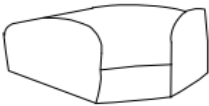
<b>BOX 1</b>				
	<b>A*1</b>	<b>B*1</b>	<b>C*1</b>	<b>D*1</b>
				
	<b>E*1</b>			
<b>BOX 2</b>				
	<b>F*2</b>	<b>G*1</b>		

# Package Contents

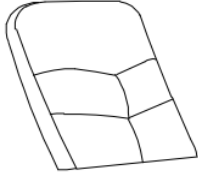
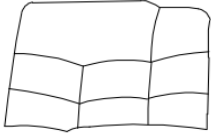
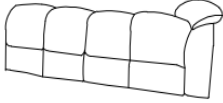
<b>BOX 3</b>				
	<b>D*1</b>	<b>H*1</b>	<b>I*1</b>	

# 1 RECLINER ASSEMBLY - BODY SETUP

## STEP1:

Remove parts from the bottom of the seat.

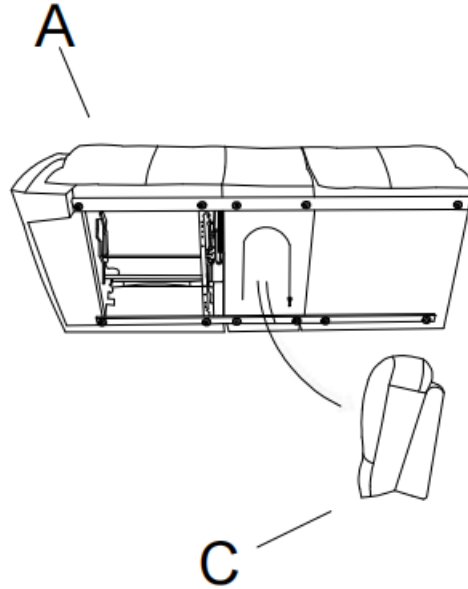

## STEP2:

Attach **Back (B&C&D&H&F)** to **Seat (A&G&I)** by aligning the **metal grooves (E)** on backrest to brackets on the mainframe as shown. Attach **Seat(A&I)** to **Center Seat(G)** by aligning the metal slots on seat to seat on the mainframe as shown. Ensure the **Seat(A&I)** slide down fully over the brackets on the **Center Seat (G)** .

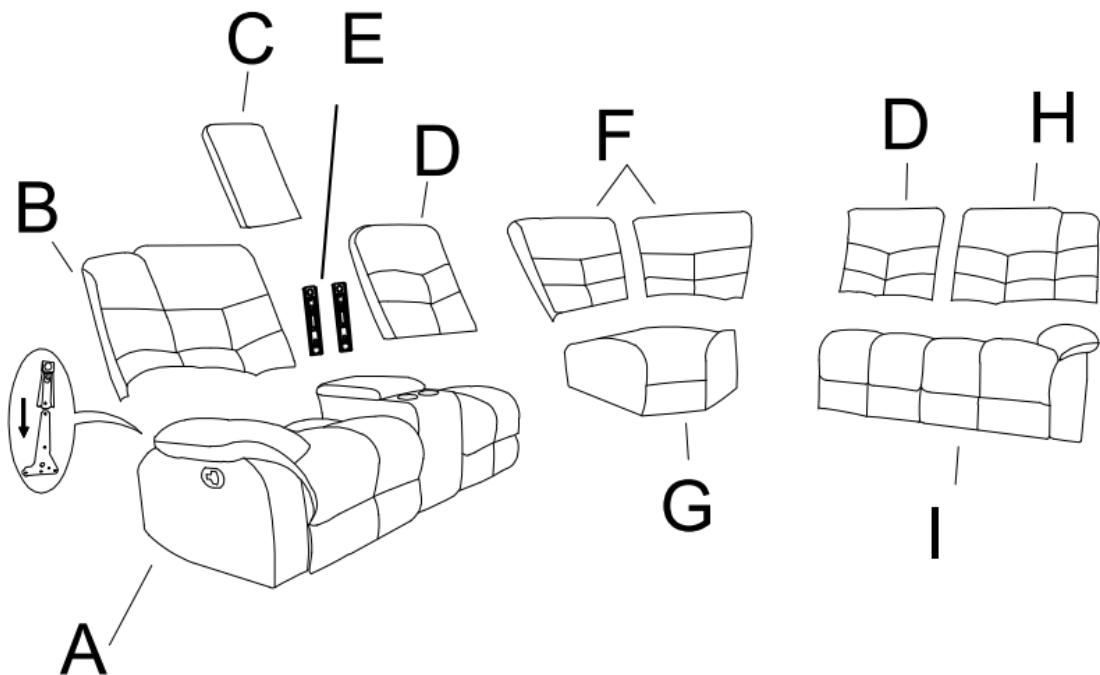

# 2 RECLINER ASSEMBLY - BODY SETUP

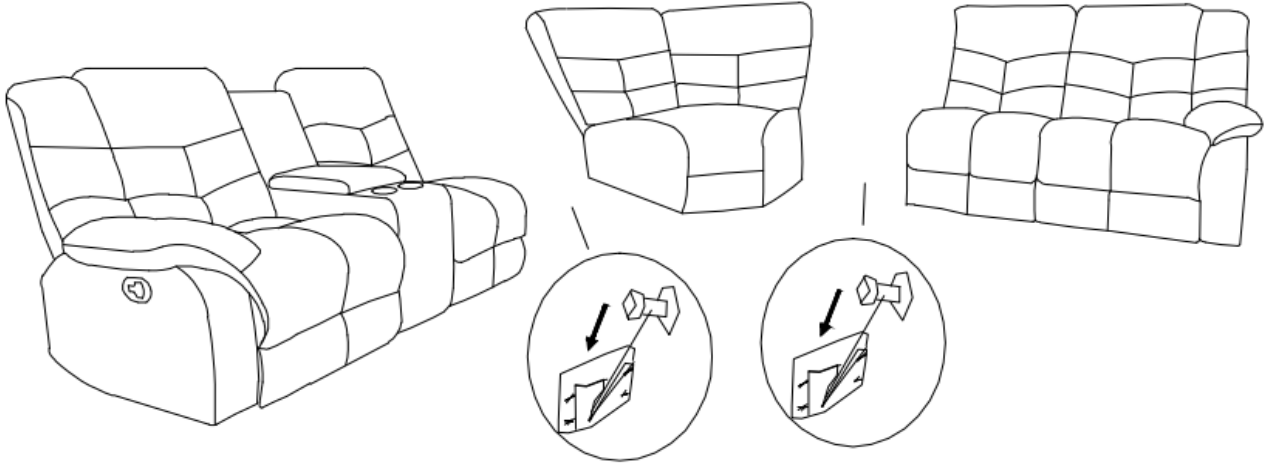

**ASSEMBLY COMPLETED**

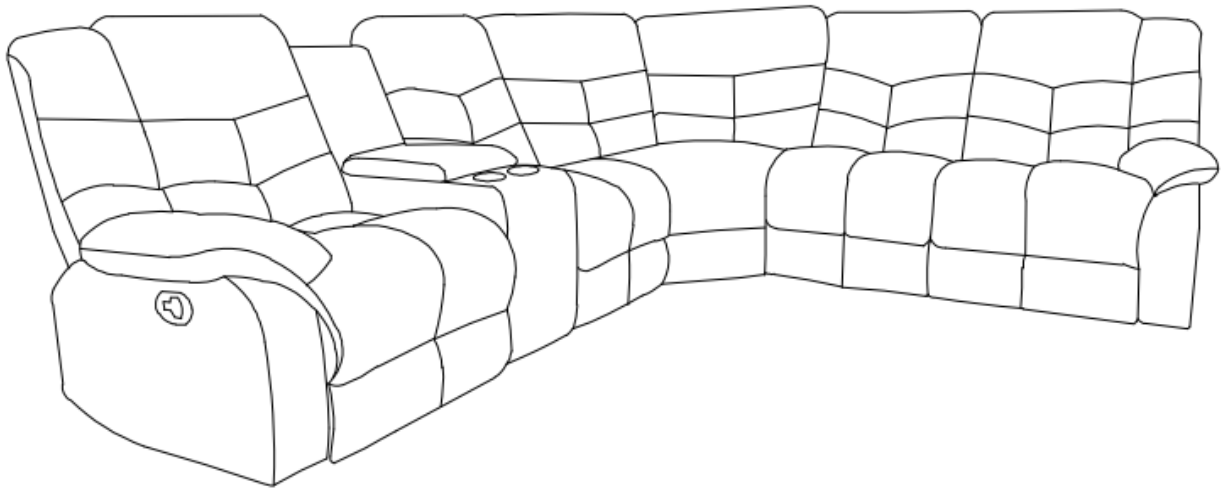

# 3 INSTRUCTIONS FOR USE - SIZE DIMENSIONS

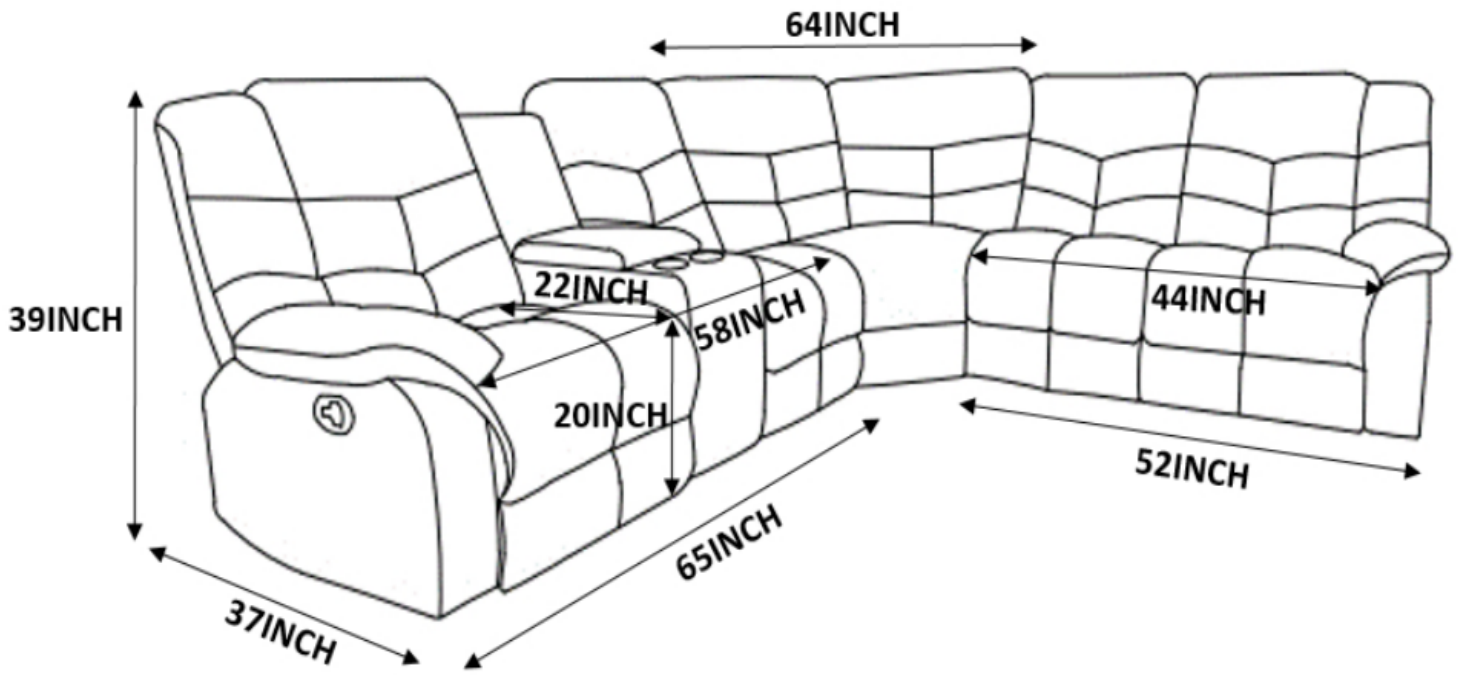

## ⚠️ WARNINGS

1. Please check if the components of the chair are all included and can be used normally.
2. Assemble all components according to the instruction correctly before you connect the chair to the power.
3. Please DO NOT sit on the armrests or footrest to eliminate the risk of tipping over.
4. If the chair is damaged or doesn't match the website description, please send clear pictures of the product and label of the carton to our service team for further help.
5. If the recliner doesn't work, you may try the following measures for self-checking firstly:
  - a) check if all the cables are connected;
  - b) check if the light of transformer is on.

If the chair still doesn't work, please feed the information back to our customer service in time and we will help you solve the matter as soon as possible.

