

INSTRUCTION MANUAL

STORAGE TOWER

BEFORE INSTALLATION

- Please list all parts as below first to check if any part is missing and make assembly easier.
- Do be careful that some parts are heavy and sharp.
- Please follow the assembly steps to install the product, if you find spare parts left, don't be worried, the left spare parts are prepared for bad ones if occurred.
- Once you hand tighten all of your bolts into place, we are going to use our wrench to fully tighten into place.
- Please do not exceed the bearing limitations of the product.
- Reconfirm that all bolts, screws, and knobs are secure every 90 days.
- Please retain these instructions for future reference.

TOOLS REQUIRED

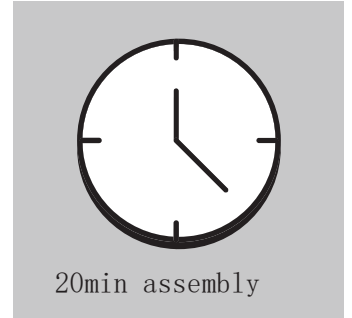
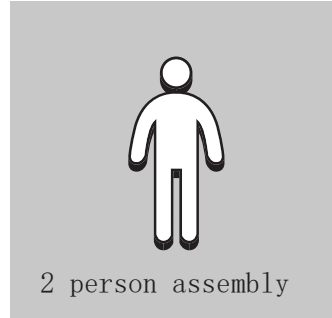
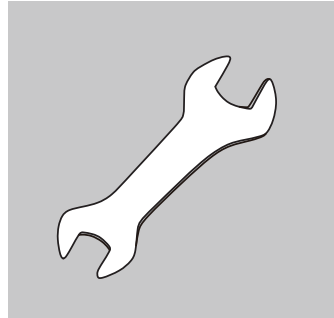
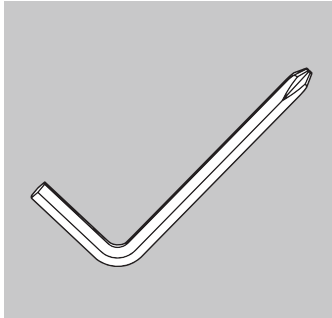

PARTS

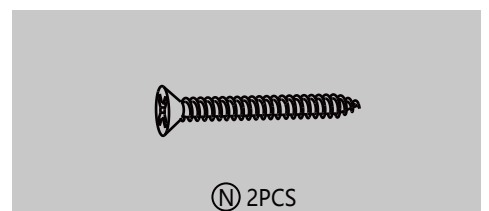
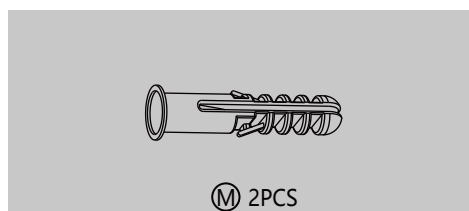
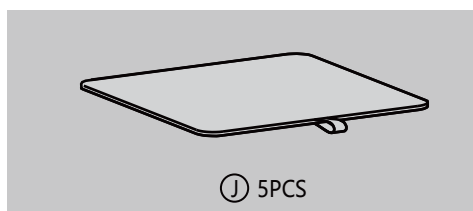
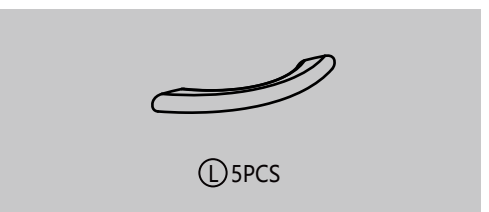
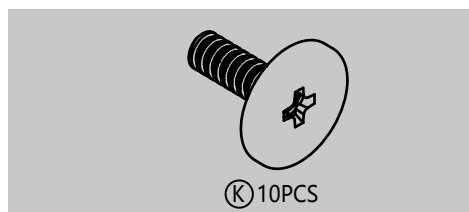
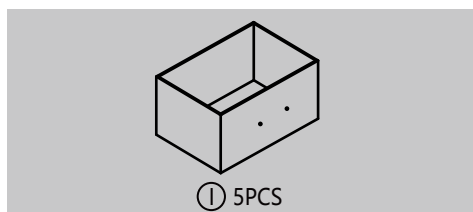
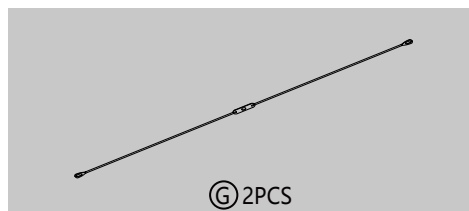
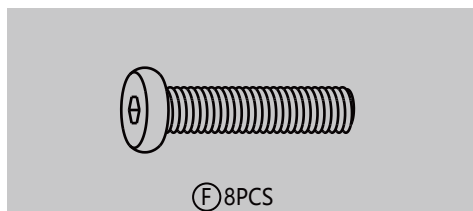
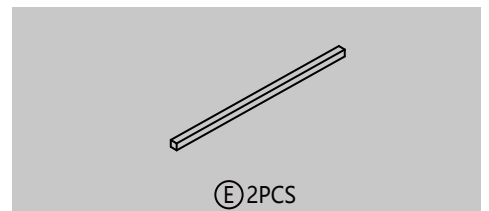
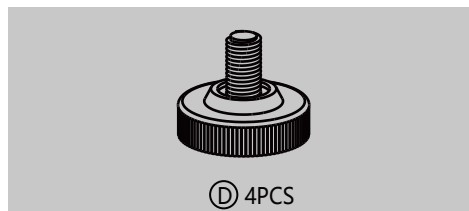
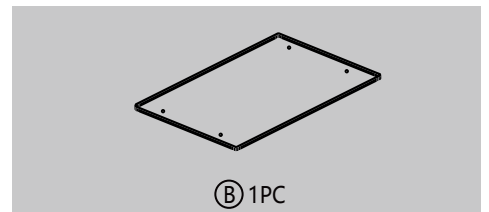
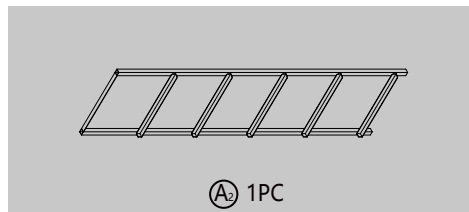
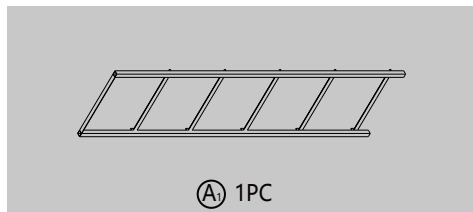

ASSEMBLY

PARTS REQUIRED

1

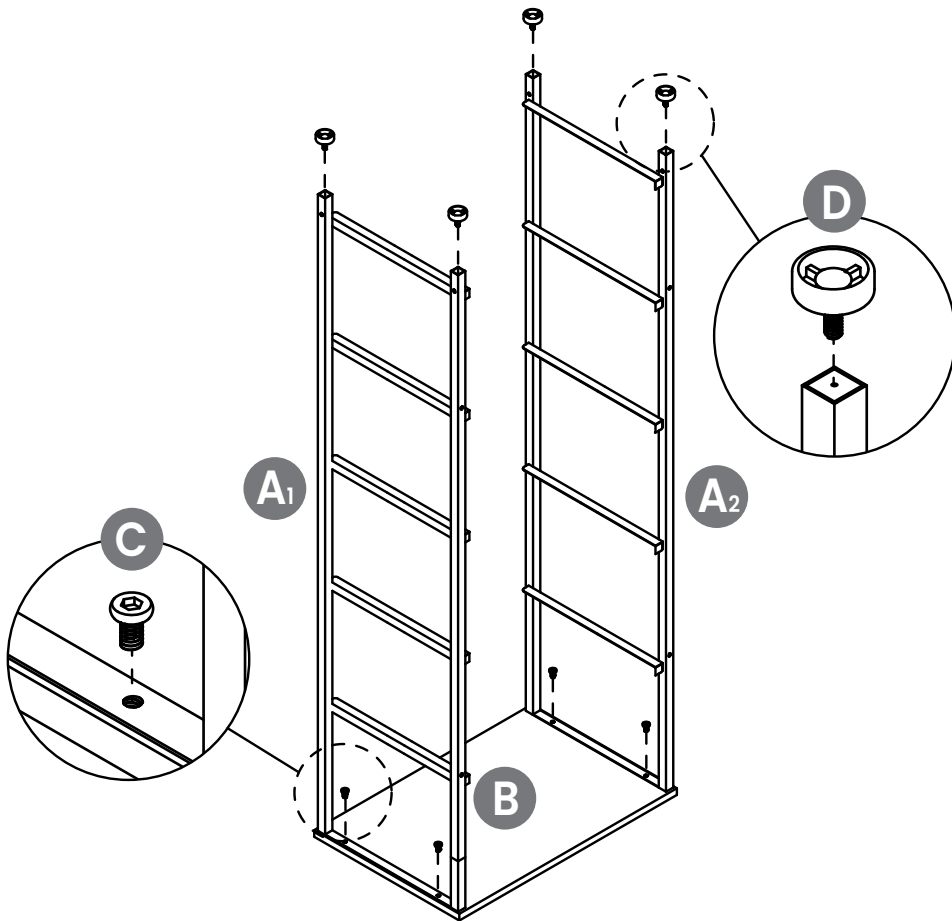

Ⓐ₁ 1PC

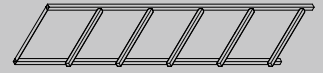

Ⓐ₂ 1PC

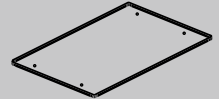

Ⓑ 1PC

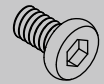

Ⓒ 4PCS

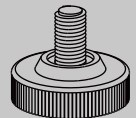

Ⓓ 4PCS

2

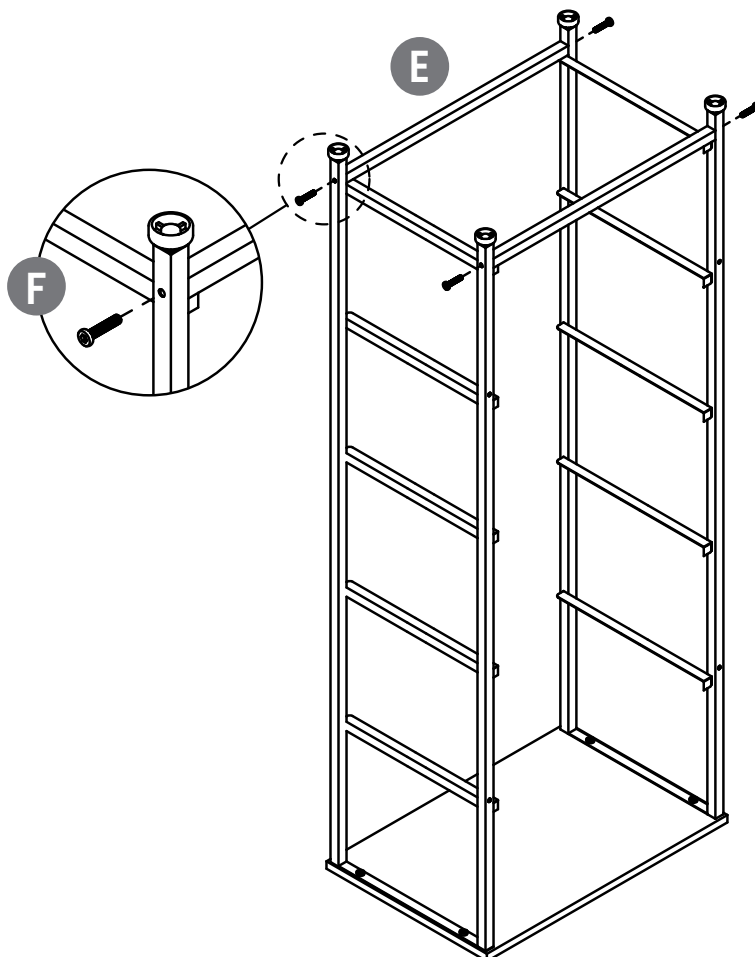

Ⓔ 2PCS

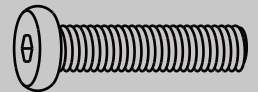

Ⓕ 4PCS

ASSEMBLY

PARTS REQUIRED

3

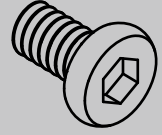
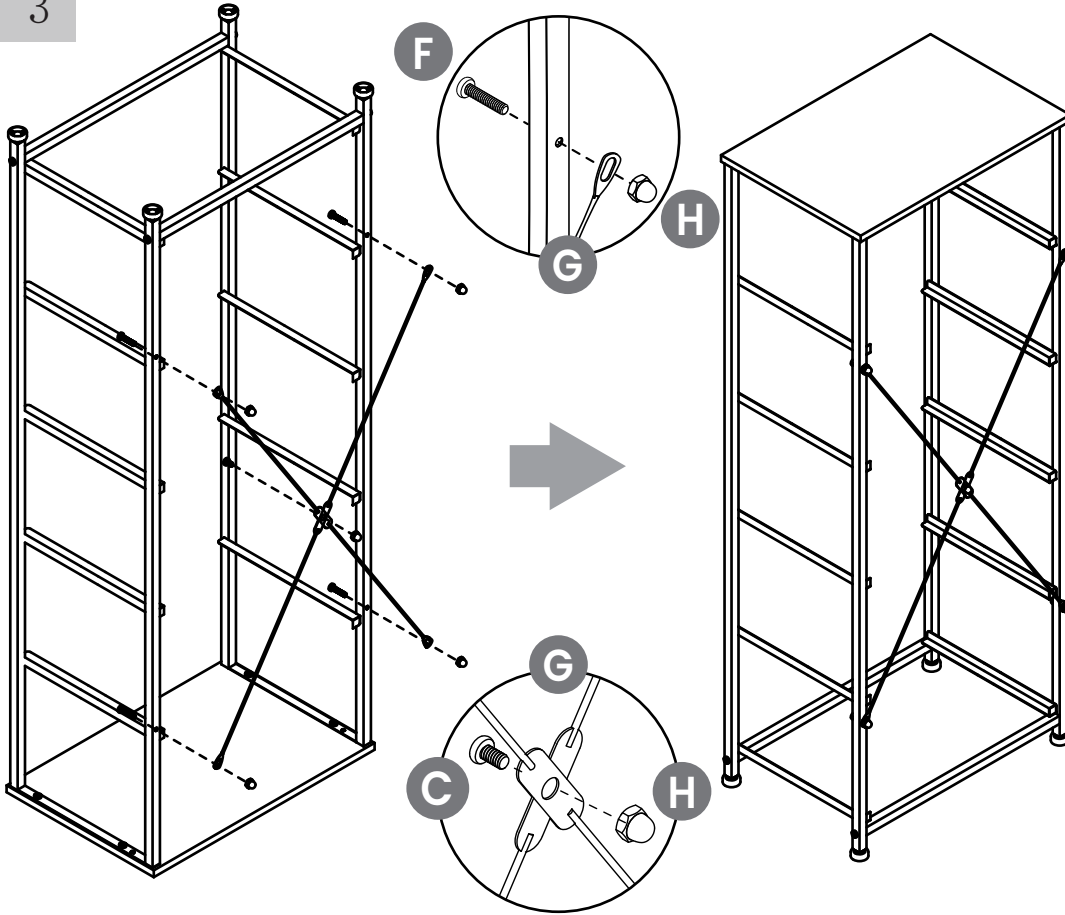

ⓐ 1PC

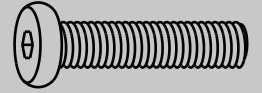

ⓑ 4PCS

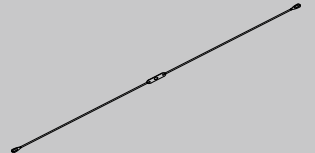

ⓒ 2PCS

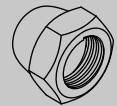

ⓓ 5PCS

4

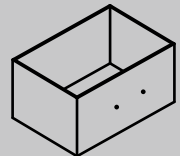
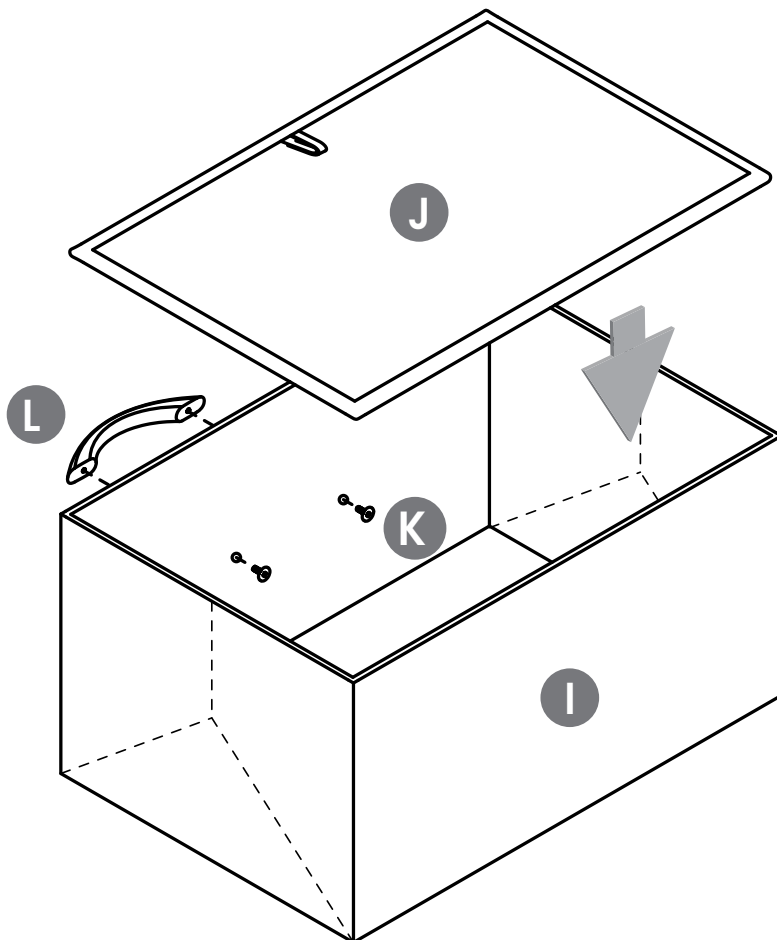

ⓔ 5PCS



ⓕ 5PCS

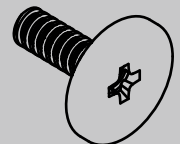

ⓖ 10PCS



ⓗ 5PCS

5

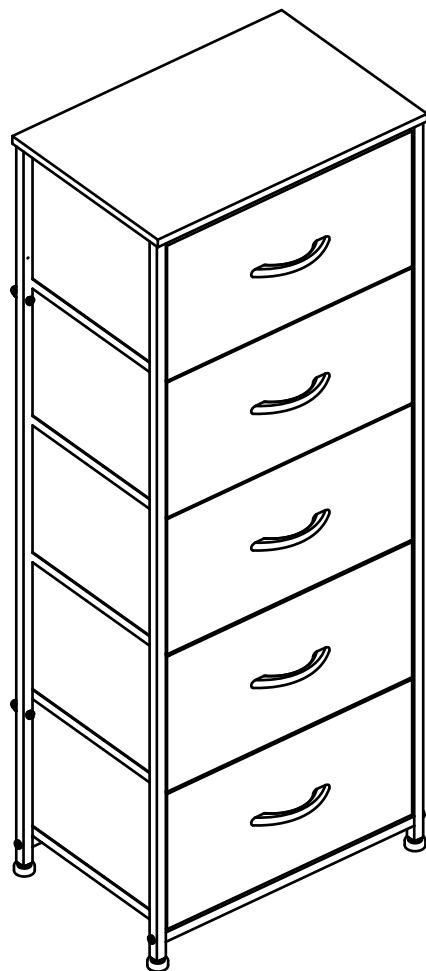

6

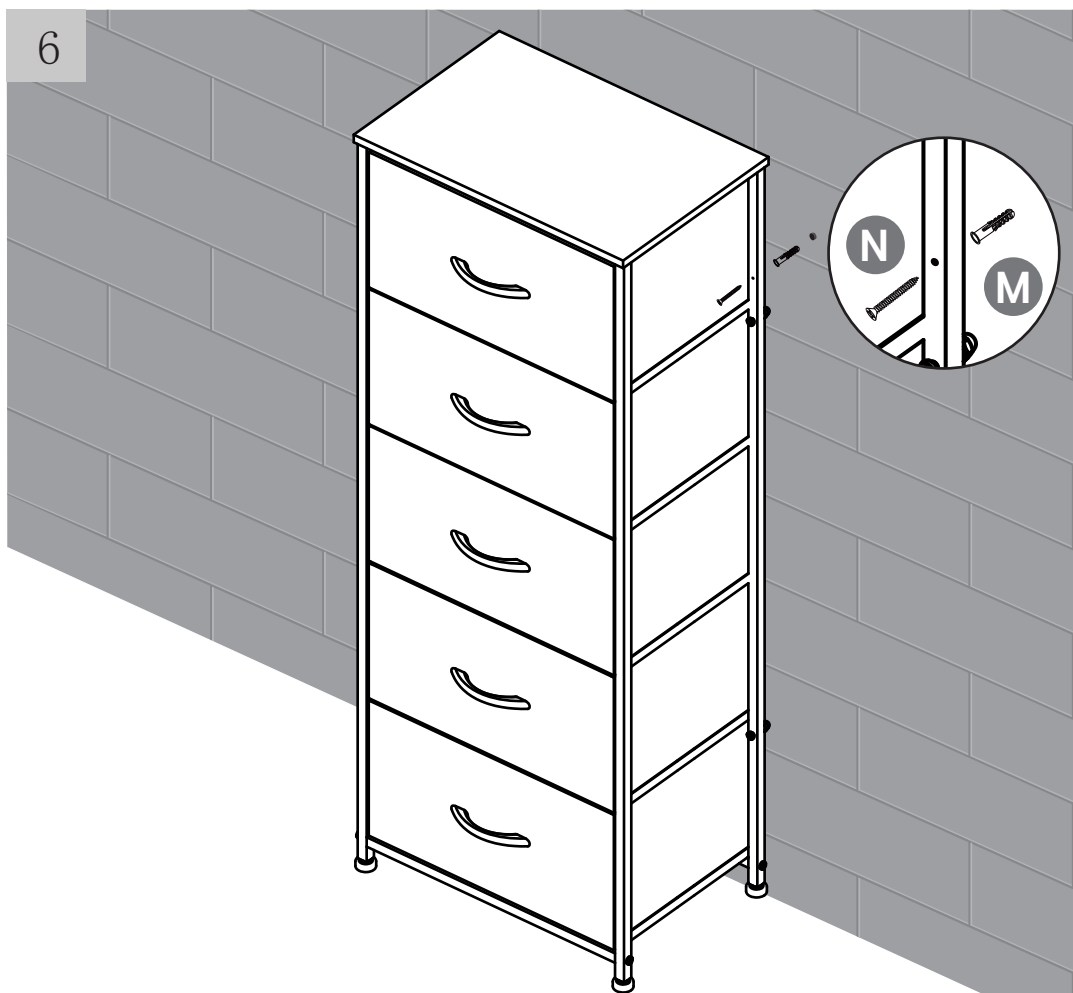

Ⓜ 2PCS



Ⓝ 2PCS