

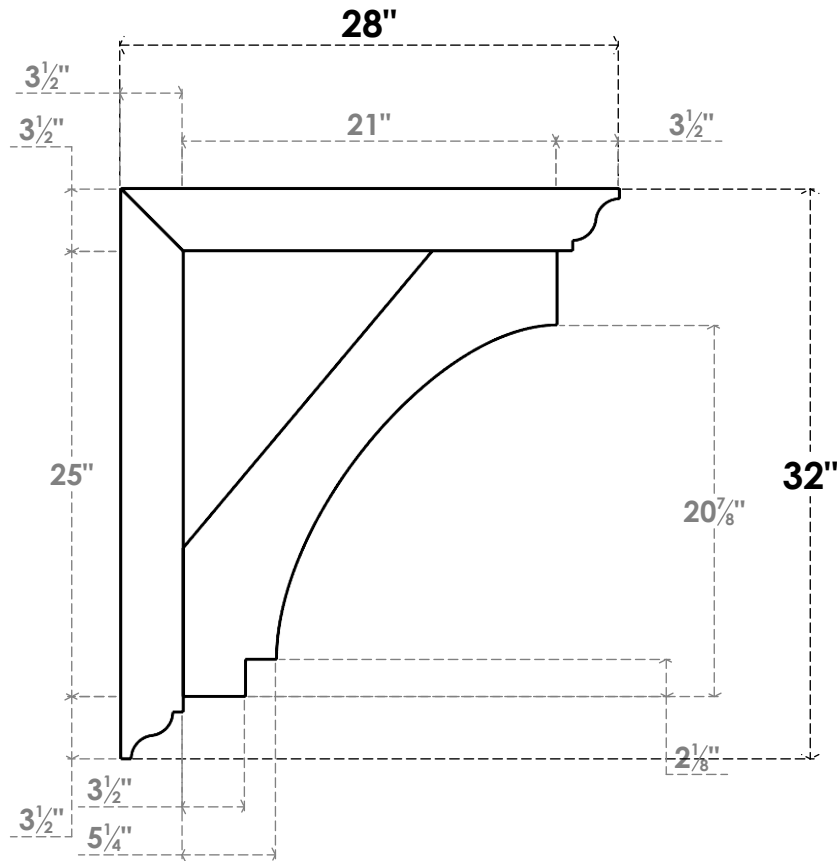

**ITEM NUMBER: BKTUROS035X035X28000X32000X035X035X035IMP00RCPR**

3 1/2"W X 28"D X 32"H X 3 1/2"T IMPERIAL ROUGH CEDAR WOODGRAIN OPEN BRACKET, TRADITIONAL TOP AND BACK, 3 1/2"W SOLID BRACE, PRIMED TAN



**SIDE PROFILE**

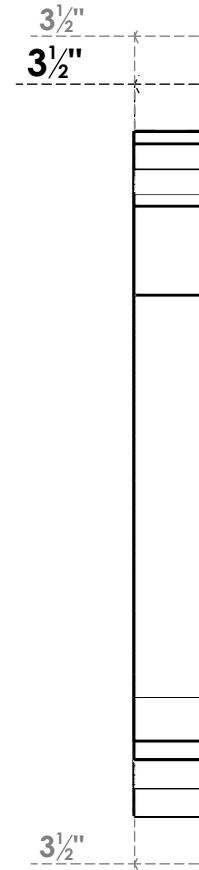

**FRONT PROFILE**

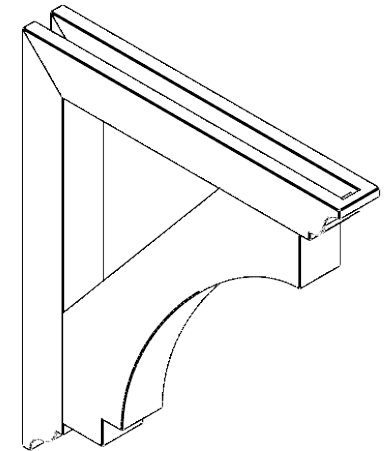

**ISOMETRIC**

GENERATED DATE : 06/18/2023



EKENA MILLWORK  
2300 WEST MAIN ST.  
CLARKSVILLE, TX 75426  
TOLL FREE: 866-607-0453  
WWW.EKENAMILLWORK.COM

**NOTES**

1. INSTALLATION TO BE COMPLETED IN ACCORDANCE WITH MANUFACTURER'S SPECIFICATIONS.
2. DRAWING MAY NOT BE TO SCALE
3. THIS DRAWING IS INTENDED FOR DESIGN AND PLANNING PURPOSES ONLY.
4. ALL INFORMATION CONTAINED HEREIN WAS CURRENT AT THE TIME OF DEVELOPMENT BUT MUST BE REVIEWED AND APPROVED BY THE PRODUCT MANUFACTURER TO BE CONSIDERED ACCURATE.
5. TIMBERTHANE ARCHITECTURAL PRODUCTS ARE MADE FROM HIGH DENSITY URETHANE AND COME FACTORY PRIMED