

KING BED

ASSEMBLY INSTRUCTIONS

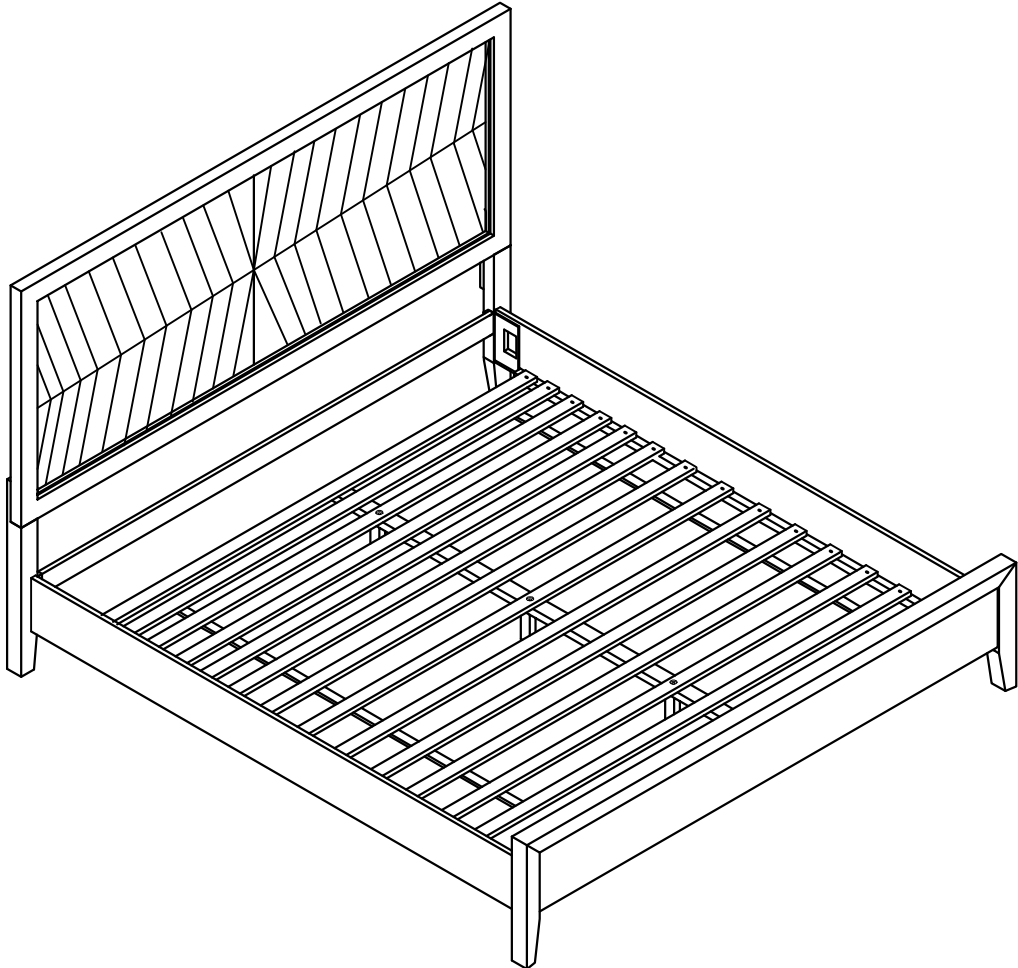

IMPORTANT SAFETY INSTRUCTIONS:

- Read all instructions carefully before unpacking assembly parts. Sharp, exposed staple tips can cause injury. For your protection, please remove any exposed staples used in packing.
- For your safety, assembly by two or more adults is recommended.
- Use only vendor supplied hardware to assemble. Using unauthorized hardware could jeopardize the structural integrity of the item.
- Keep instructions for future use.
- Intended for residential use only.
- Keep small parts and hardware out of the reach of children.







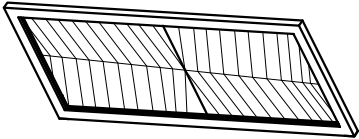
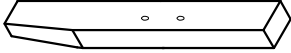
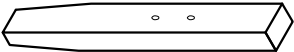

PRE-ASSEMBLY INSTRUCTIONS:

- Remove all parts and hardware from the box and place them on a carpeted or scratch-free work surface.
- To avoid accidentally discarding small parts or hardware, please do not dispose of any contents until assembly is complete.
- Prior to starting assembly, use the parts and hardware lists to identify and separate each of the pieces included.
- Do not over-tighten screws or bolts.

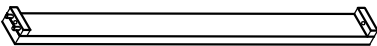
TABLE OF CONTENTS



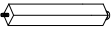



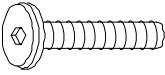

<u>Parts List</u>	<u>Page 3</u>
<u>Hardware List</u>	<u>Page 4</u>
<u>Assembly Instructions</u>	<u>Page 5-6</u>
<u>Care & Maintenance & Warnings</u>	<u>Page 7</u>

PARTS LIST

PART#	PICTURE	PART DISCRIPTION	QTY
A		HEADBOARD	1
B		LEG LEFT	1
C		LEG RIGHT	1
D		WOOD LINK	2
E		SAFEFY RAIL	1
F		FOOTBOARD	1
G		SIDE RAILS	2
H		SLATS	13
I		SUPPORT LEG	3
J		SLATS RAILS	1

Thank you for your purchase. Be sure to check all packing material carefully for small parts which may have come loose inside the carton during shipment. Identify and count all parts and compare with the parts and hardware lists.

HARDWARE LIST

PART#	PICTURE	PART DISCIPTION	QTY
1		Bolt Ø5/16"x50mm	18
2		Lock washer Ø 5/16"	26
3		Flat washer Ø5/16"x19x1.5mm	18
4		Allen Key	1
5		Threaded Bolt Ø5/16"x88mm	8
6		Hex Nut	8
7		Flat washer Ø5/16"x16x1.5mm	8
8		Wrench	1
9		Screws #8 x 30mm	26

Phillips screwdriver also needed for assembly (not included).

Thank you for your purchase. Be sure to check all packing material carefully for small parts which may have come loose inside the carton during shipment. Identify and count all parts and compare with the parts and hardware lists.

STEP 1

Attach Legs

1. Align wood link (D) and fasten left (B) & right (C) headboard leg to headboard panel (A) using large lock washer (2), large flat washer (3) and bolt (1). Do not fully tighten at this step.
2. Align and fasten bottom rail (E) to left (B) & right (C) headboard leg using small lock washer (2), small thin small flat washer (3) and short bolt (1). Then fully tighten all the bolts at step 1 & step 2 with Allen wrench (4).

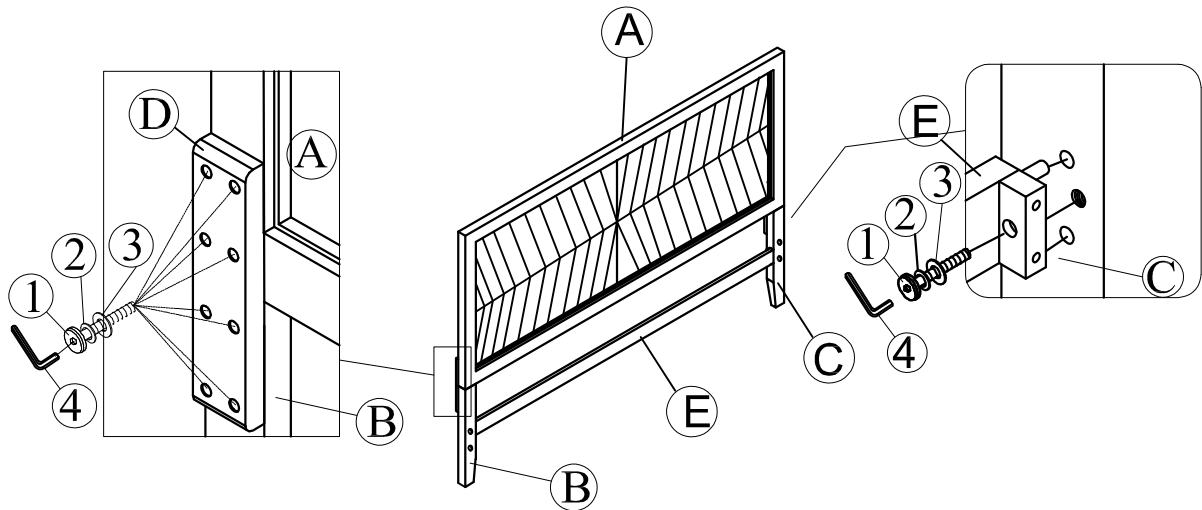

STEP 2

Attach Rails

1. Align and screw in threaded bolt (5) to left (B) and right (C) headboard leg and footboard (F) by turning clockwise until tight.
2. Align and fasten bed rail (G) to headboard leg (B&C) and footboard (F) using small lock washer (2), small thin small flat washer (7), large Hex screw nut (6). And fully tighten with wrench (8).

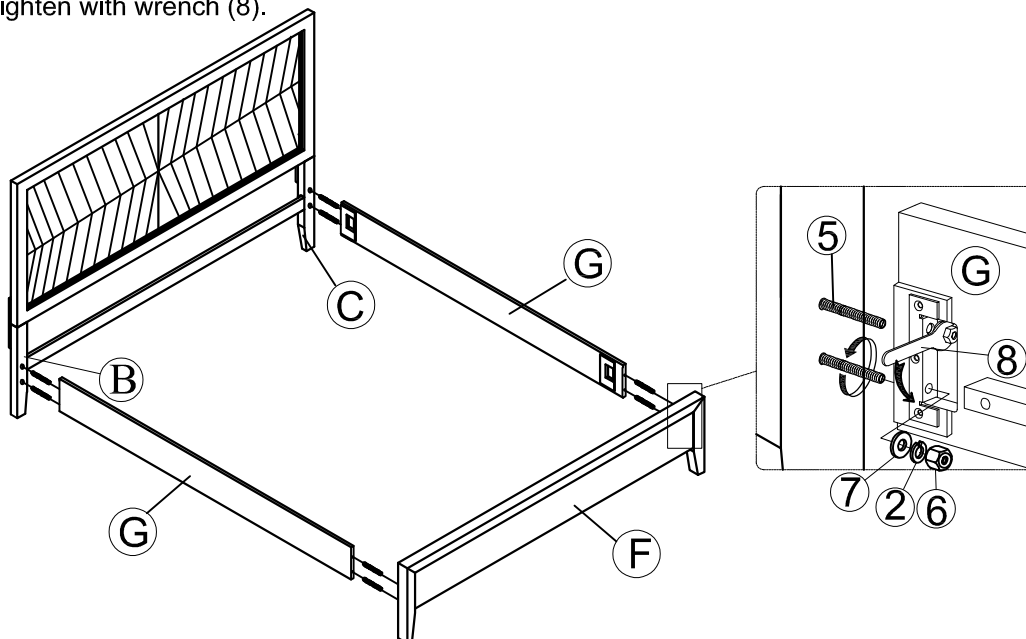

STEP 3

Attach Support Legs

1. Align and screw in bed slat support with leveler (I) to bed slat (H) and slats rails (J) by turning clockwise until tight.
2. Adjust leveler to touch the floor.

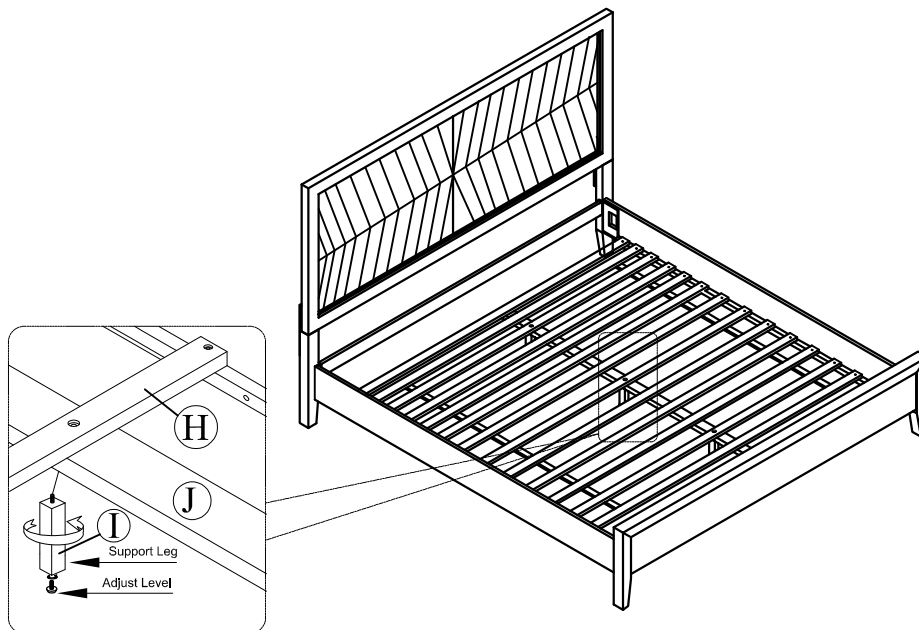

STEP 4

Attach Slats

1. Align and fasten bed slat (H) to bed rail (G) using wood screw (26) and fully tighten with screw driver (NOT INCLUDED).

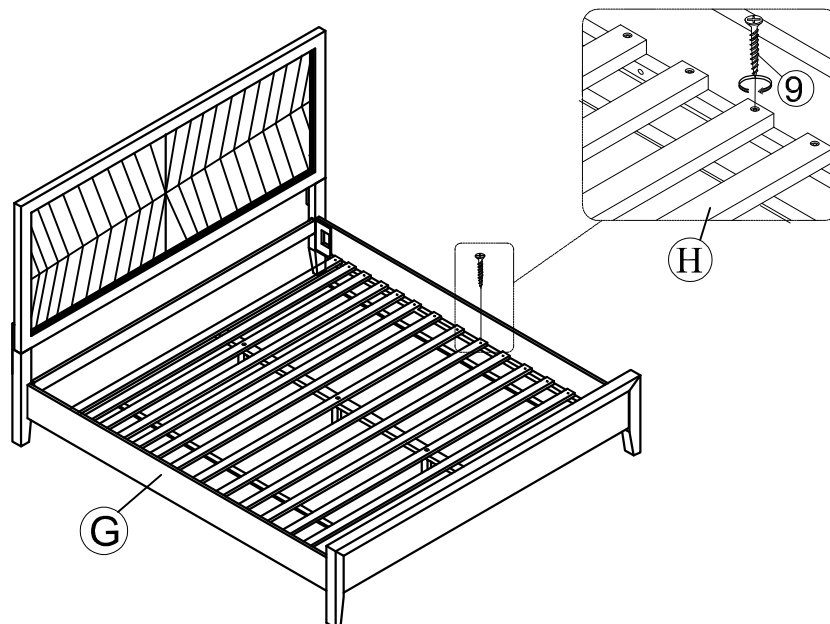

CARE & MAINTENANCE

Wood Care Tips

- Wood color can fade and/ or sun bleaching can occur when exposed to direct sunlight over a long period of time.
- Avoid placing your furniture in direct sunlight.
- Rearrange accessories over time to prevent spot bleaching.
- For daily maintenance, use clean and soft rags or cloths to wipe off dust on the surface along the grains.
- Never use damp rags or anything with a hard surface to rub onto the furniture.
- Always keep surfaces clear of any acid or chemical substances.
- To avoid damage refrain from stacking large and/or heavy objects on top of the furniture.
- Avoid cleaners which use chemical products. Many of these are harsh and not safe for use on upholstery.



WARNING



- Do not use this product unless all screws and bolts are securely tightened.
- Check that all screws and bolts are secure every three months or as needed
- Dispose of packing material properly. Do not use plastic cover as head covering as it may cause suffocation.
- Do not use this product as a stepladder.
- Use this product for intended purpose only.
- Intended for residential use only.