



Assembly Instructions

Caution: You must read this before you proceed.



Chair

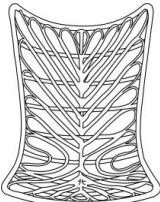
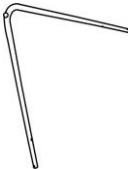
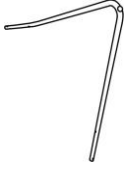





Parts List

Label	Picture	Description	QTY
A		Seat	1
B		Right Back Leg	1
C		Left Back Leg	1
D		Front Leg	1

Hardware

Label	Picture	Description	QTY
①		Allen Wrench	1
②		Bolt (M6x40MM)	4
③		Bolt (M6x13MM)	7

④		Washer (M6*14*1MM)	14
⑤		Nut (M6)	4
⑥		Nut Cap	4
⑦		Nut Cap	10
⑧		Wrench	1

Assembly Preparation

Before Beginning Assembly:

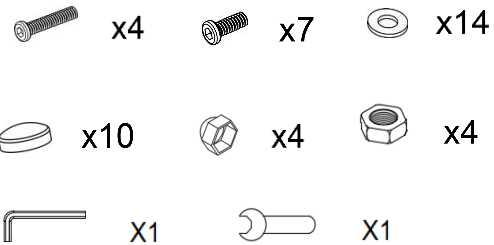
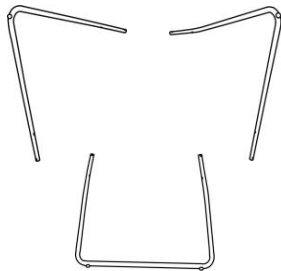
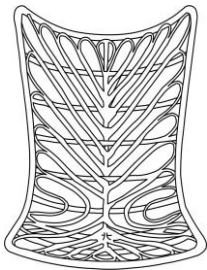

- Read instructions, cover to cover-



- Have 2 adults on hand for assembly-



- Do not assemble on flooring or carpet-



- Assemble on a clean non-marring surface (packing foam)-



- Save all packaging until finished-

Assembly Steps

Overview

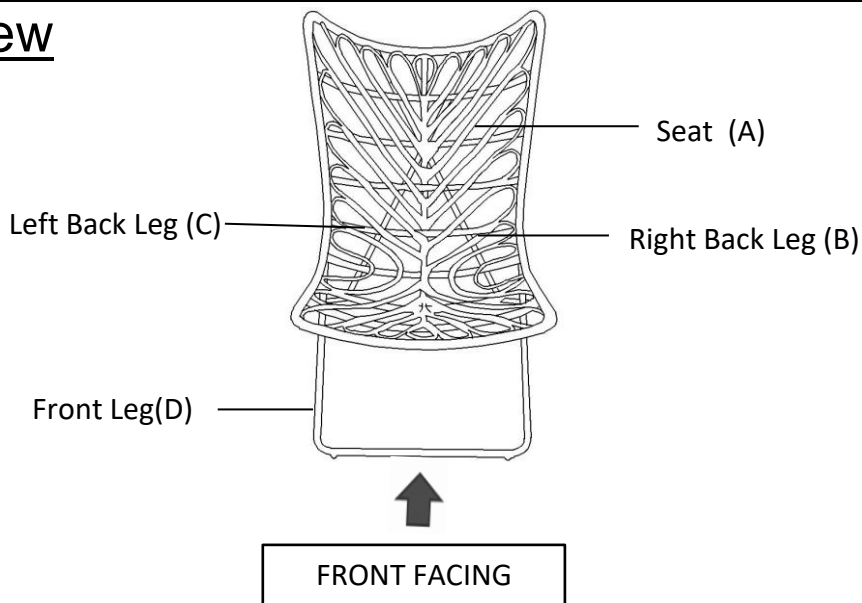

This Chair has multiple parts and may require up to some 30 minutes to assemble. To give you an overview of the Chair parts, the above picture is to help you put the various parts into perspective. Please read through the instructions below to familiarise yourself with the parts and steps before assembly.

Step 1

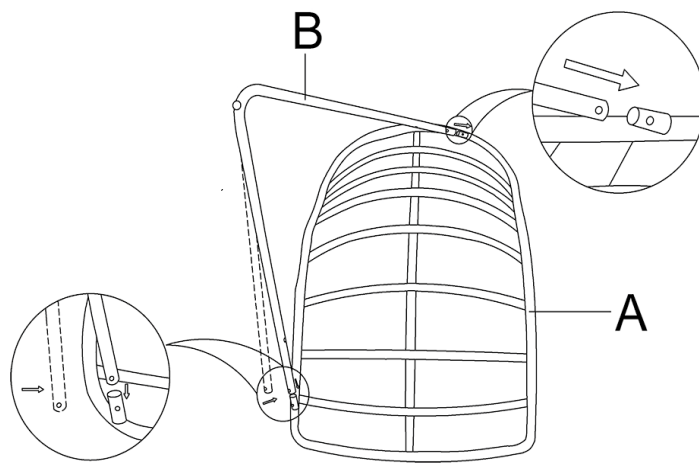

Open the carton and place all the parts onto a clean, non-marring surface.
Please insert the Right Back Leg (B) into the Seat (A) as shown in the picture.

Step 2

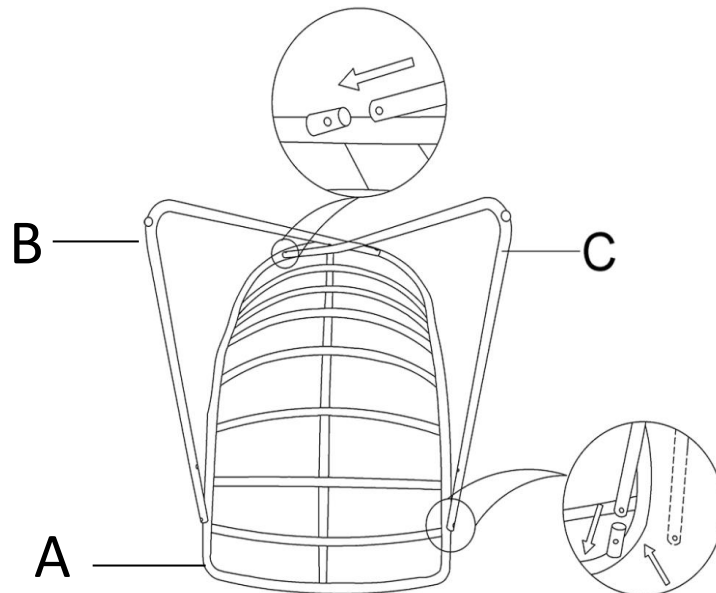

Insert the Left Back Leg (C) into the Seat (A) as shown in the picture.

Step 3

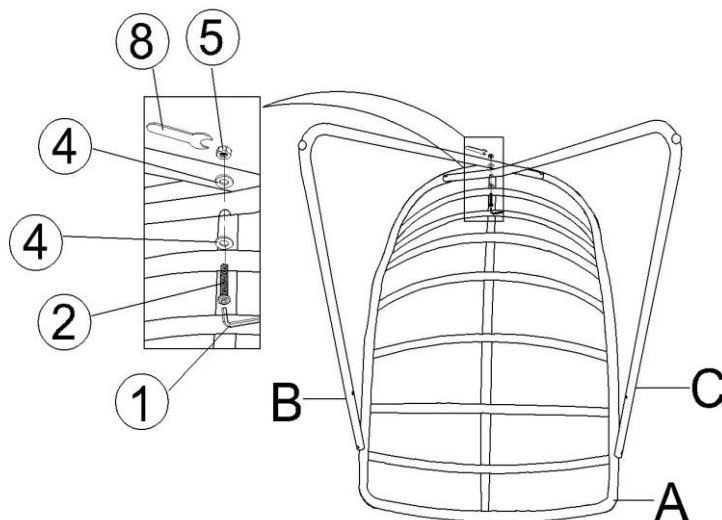

Attach the Right Back Leg (B) and the Left Back Leg (C) together using Bolt (2), Washer (4) and nuts (5) with the Allen Wrench (1) and Wrench (8) as shown in the picture.

Do not fully tighten the bolts.

Step 4

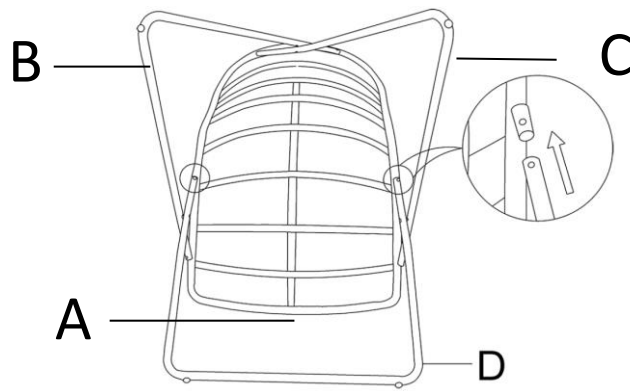

Insert the Front Leg (D) into the Seat (A) as shown in the picture.

Step 5

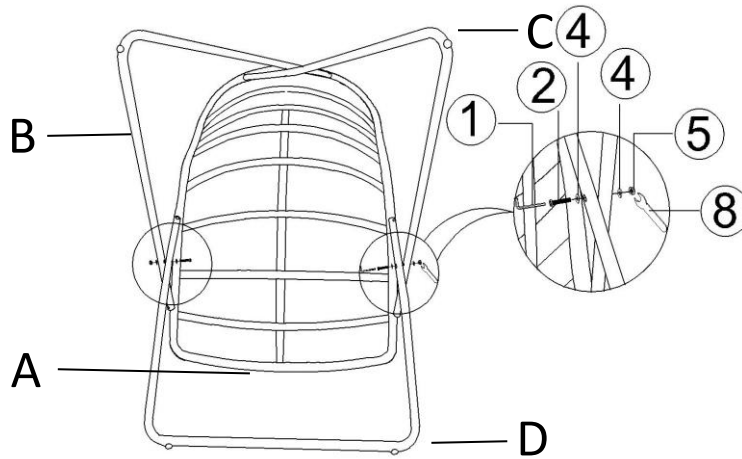

Attach the Front Leg (D) and the Left Back Leg (C) together using Bolts (②), Washers (④) and Nuts (⑤) with the Allen Wrench (①) and Wrench (⑧) as shown in the picture.

In the same way, Attach the Front Leg (D) and Right Back Leg (B) together using Bolts (②), Washers (④) and Nuts (⑤) with the Allen Wrench (①) and Wrench (⑧) as shown in the picture.

Do not fully tighten the bolts at this time.

Step 6

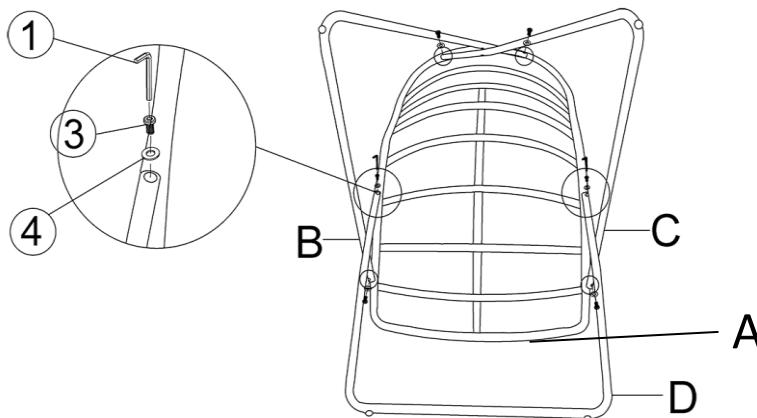

Attach the Right Back Leg (B), the Left Back Leg (C) and the Front Leg (D) to the the Seat (A) respectively using Bolts (③) and Washers (④) with the Allen Wrench (①) as shown in the picture.

Check for stability and then tighten all Bolts at all joints.

Note: DO NOT fully tighten a Bolt in one go and then move on to the next. Rather in a sequential manner, gradually tighten each Bolt until all Bolts are evenly secured. This methodology will ensure maximum evenness once all Bolts are fully tightened.

Step 7

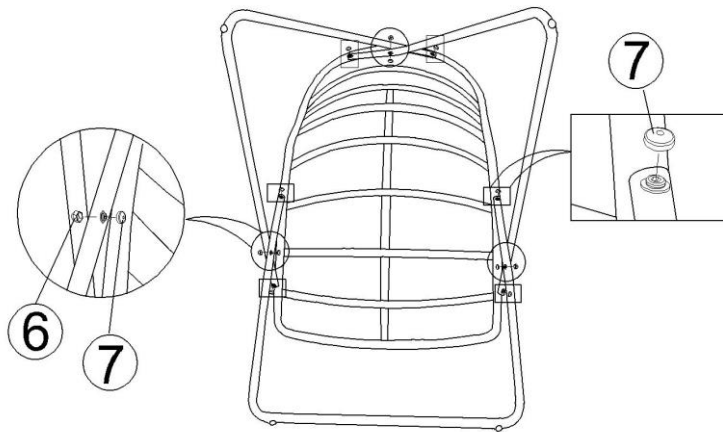

Add the Nut Caps(⑥,⑦) on the 9 Bolts as shown in the picture above.

Step 8

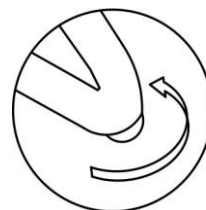
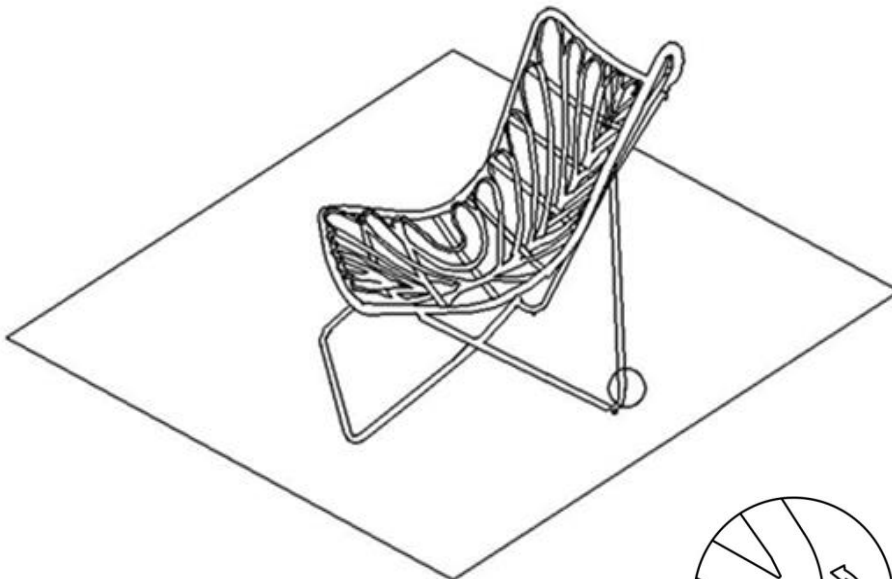











Adjust Pre-installed
Levellers height for
balance

Place the Chair on a **LEVEL SURFACE** to check for wobbles.

If it wobbles, adjust the Legs Pre-installed Levellers until the Chair is level with the ground.

Your Chair is ready for use. This Chair can only be used on a flat, level surface.

Care & Maintenance

- ⊘  ● Prolonged exposure to rain may cause rusting which can stain floors.
 - ⊘  ● Do not put hot items directly on furniture surface.
 - ⊘  ● Do not clean furniture with harsh cleansers or polish.
 - ✓  ● To obtain the longest lifespan of your outdoor products, minimizing exposure to direct sunlight is recommended.
 - ⊘  ● Children should not climb or jump on the furniture.
 - ⊘  ● Do not write on furniture without a padded barrier to protect the surface.
 - ✓  ● To obtain the longest lifespan of your outdoor products, avoid extended and lengthy exposure to rain, snow, and direct sunshine. Whenever possible cover the product and /or place under patio or awnings.
 - ⊘  ● Not for commercial use. For residential use only.
 - ⊘  ● Stains may be removed with mild soap solution and damp cloth.
 - ✓  ● Keep away from sources of ignition.
-
- ✓  ● Dust and pick-up spills using a clean, non-colored, lint-free cloth.