

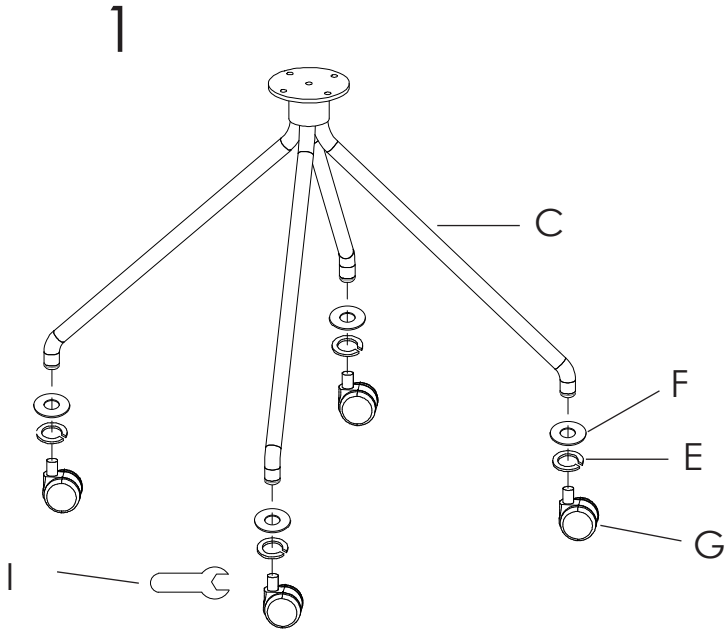

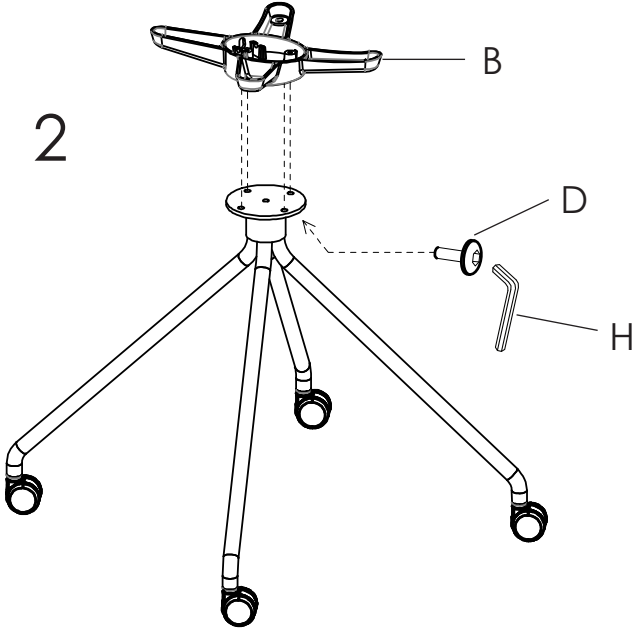







PLEASE NOTE: Check that you have received all components and hardware before assembling.

# Assembly Instructions Office Chair



Hand tighten the casters (Part G) first. When the casters are in place, use the wrench (Part I) to tighten completely.



-   
A (1 pc)
-   
B (1 pc)
-   
C (1 pc)
-   
D (4 pcs)
-   
E (4 pcs)
-   
F (4 pcs)
-   
G (4 pcs)
-   
H (1 pc)
-   
I (1 pc)

During assembly, hand tighten screws only. When the screws are in place, tighten completely.

PLEASE NOTE: Check that you have received all components and hardware before assembling.

# Assembly Instructions Office Chair

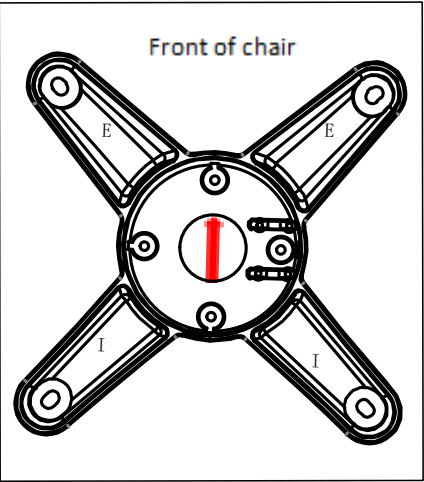
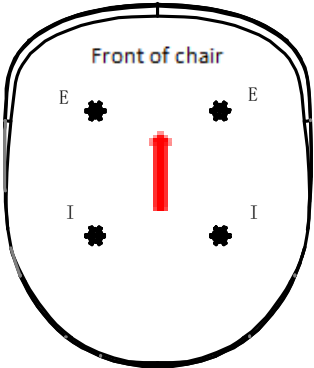

Assemble the seat according to the corresponding letters. Letters E & E must face the front of the chair.

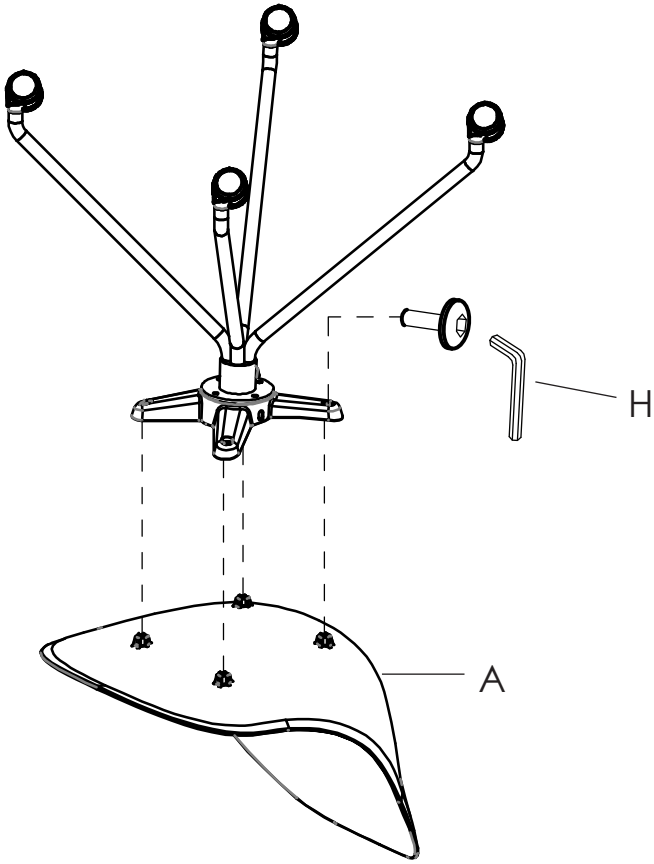

During assembly, hand tighten screws only. When the screws are in place, tighten completely.