

Owner Manual

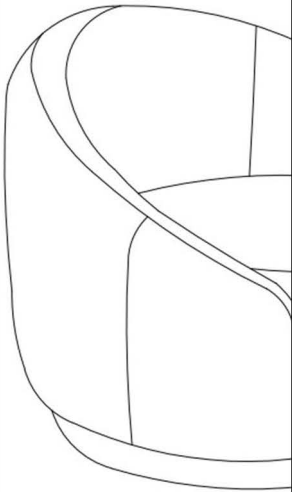

WARRANTY

We strive to offer high quality product and we also try our best to satisfy each customer that order from us, no matter on products or services as needed. Each customer receives a record of their order, such as the order number or item receipt. For any items that are out of warranty period, you may still be able to purchase the replacement parts from our company if they are available.



MAINTENANCE AND WARNING

Please read the manual thoroughly
before you start installing.

Please keep the product away from
sharp object.

Packaging and small parts may have
chocking hazard, please keep them away
from children and pets.

Please clean the product according to each
clean code, check the product description
for more information.

Please keep the product away from
fire.

If you have any other questions, please
contact us, we will be glad to help you out.

If the product is placed under direct
sunlight, the pattern or color might fade
away overtime.

Check the product periodically to make
sure everything is secured and tightened.

Always use proper tools for installation.

Do not jump on the product.

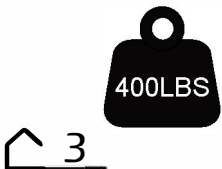

PRODUCT DESCRIPTION

The semi-surround backrest is ergonomically designed to provide excellent lumbar support, ensuring hours of comfort whether you're relaxing or working.

Upholstered in soft cotton fabric, this chair is breathable, keeping you cool and cozy at all times.

The solid wood frame gives it exceptional strength and durability, making it perfect for everyday use.

The 360 degree swivel base allows for easy rotation, providing flexibility to move in any direction without needing to stand up.

With minimal assembly needed, you can quickly set up and enjoy the chair's style and comfort in your living space.

EXPLODED VIEW

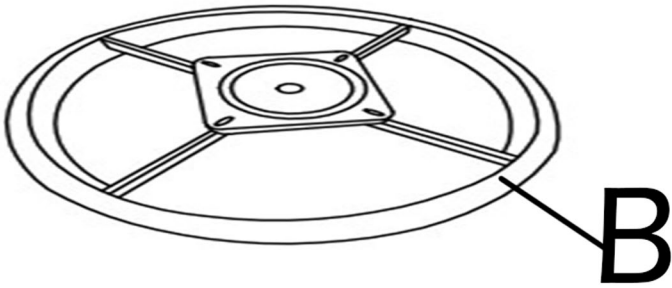
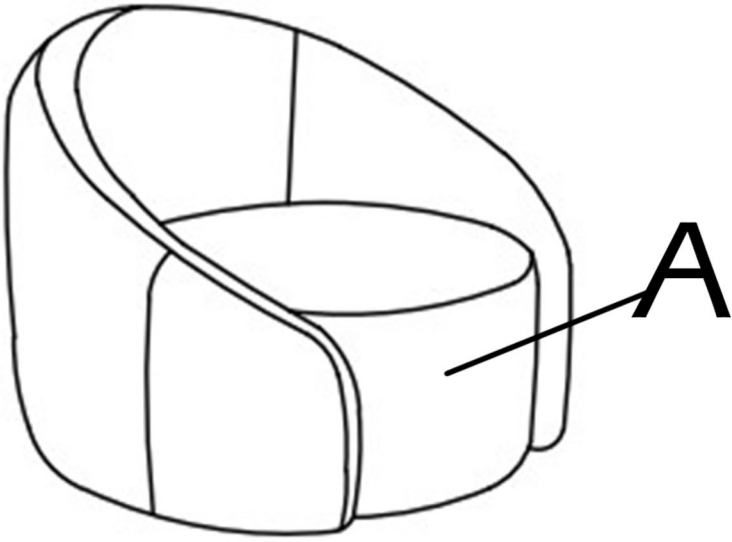

PARTS

A*1

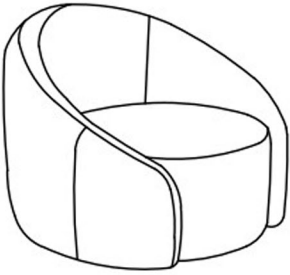

Seat

B*1

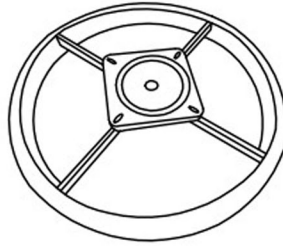

Rotary base

HARDWARE

TOOL LIST

NOTE: Designated with (★) We provide additional spare parts in the hardware package

①*4

M6*16mm



★ Bolt

②*1

M6



Allen Key

Please make sure all hardware & packing material fitting the list. Especially some small accessories may be missing during transportation. Please contact us if you have any question.

step 1

Turn the rotary part on swivel base (B) to the staggered position as shown. Make sure you can clearly see the bolt holes on the lower part of the rotary base.

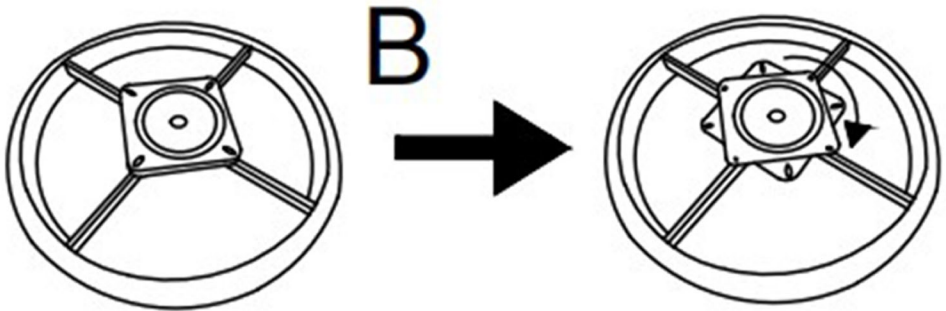

step 2

Align the bolt holes on the swivel base (B) with the holes on the sofa (A), use the allen key (2) to tighten the bolts (1). Please tighten the bolts to 50% first, and make sure all the bolts are correctly aligned, then use the allen key provided to fully tighten all the bolts.

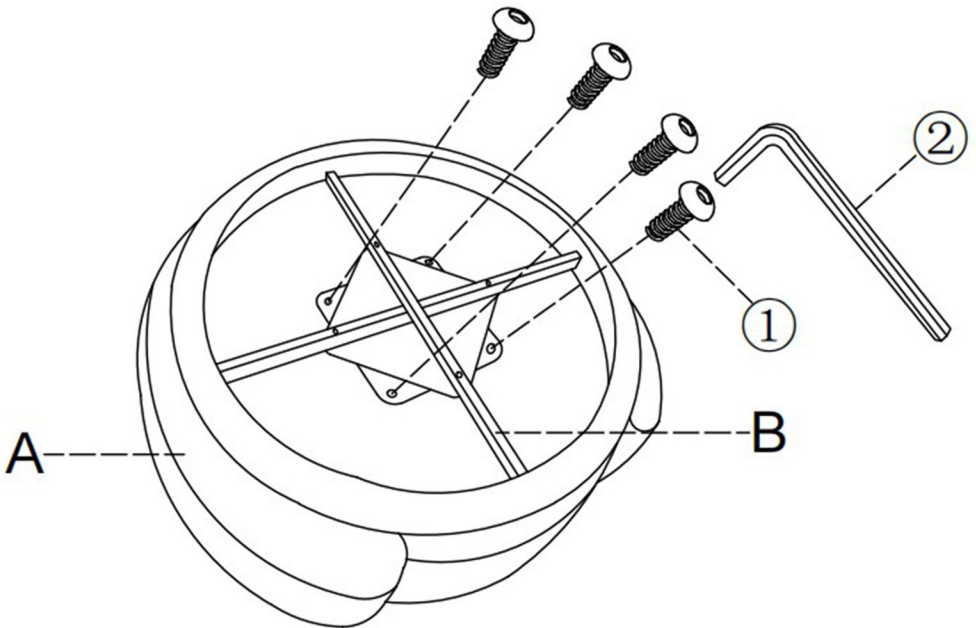

step 3

Adjustable height foot nails are installed at the bottom of the chair. If the ground is uneven or the chair is unstable, you can adjust the foot nails at the base to stabilize the chair.

